



SPECCHI E ILLUMINAZIONE

MIRRORS AND LIGHTING

illuminazione a LED 4000 K. Su richiesta illuminazione
a LED 3000 K senza maggiorazione di prezzo.

*LED lighting 4000 K. Upon request LED lighting 3000 K
available without additional surcharge.*

CIRCUS SUNRISE

_2019

design
AL Studio





illuminazione a LED 4000 K. Su richiesta illuminazione a LED 3000 K senza maggiorazione di prezzo.

LED lighting 4000 K. Upon request LED lighting 3000 K available without additional surcharge.

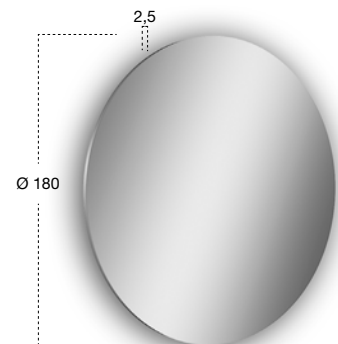

P	Ø	art.	art.
2,5	180	CIRCUS180	CIRCUS180W Con illuminazione a led / With led lighting

Specchio spess. 5 mm a filo lucido con o senza illuminazione a led luce bianca, completo di telaio.

Polished edge mirror 5 mm thick with or without white led lighting, complete with frame.





illuminazione a LED 4000 K. Su richiesta illuminazione a LED 3000 K senza maggiorazione di prezzo.

LED lighting 4000 K. Upon request LED lighting 3000 K available without additional surcharge.

P	Ø	art.	art.
2,5	72	CIRCUS72	CIRCUS72W Con illuminazione a led / With led lighting
	90	CIRCUS90	CIRCUS90W Con illuminazione a led / With led lighting
	108	CIRCUS108	CIRCUS108W Con illuminazione a led / With led lighting
	120	CIRCUS120	CIRCUS120W Con illuminazione a led / With led lighting
	140	CIRCUS140	CIRCUS140W Con illuminazione a led / With led lighting

Specchio spess. 5 mm a filo lucido con o senza illuminazione a led luce bianca, completo di telaio.

Polished edge mirror 5 mm thick with or without white led lighting, complete with frame.

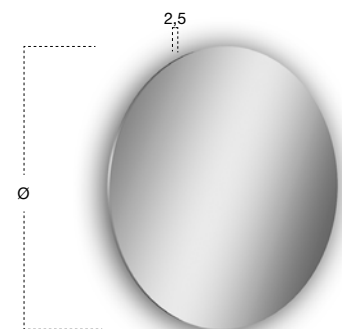

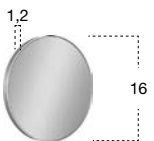
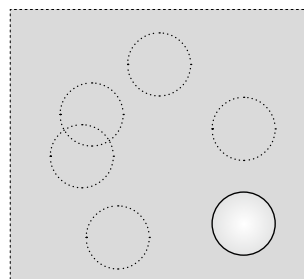
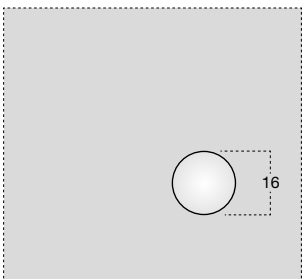

H	art.
50	FOCUS50
75	FOCUS75
90	FOCUS90
100	FOCUS100
110	FOCUS110

Ingranditore 2x completo di piastra magnetica, per specchi Art. ORMA, Art. VARIO, art. VERTICE e art. FILA.

Magnifying mirror 2x complete with magnetic plate for mirrors Art. ORMA, Art. VARIO, art. VERTICE and art. FILA.

Ø	P	art.
16	1,2	FOCUS

Secondo ingranditore 2x.

Second magnifying mirror 2x.

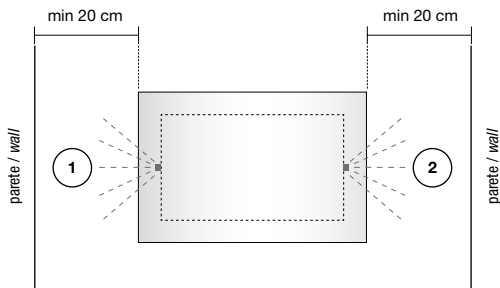

art.
MAGIC

Interruttore di comando accensione a infrarossi per specchio Art. ORMA e Art. VARIO. I numeri cerchiati indicano le diverse possibilità di posizionamento dell'interruttore.

Infrared lighting control device for mirrors Art. ORMA and Art. VARIO. The circled numbers indicate the different switch positions.



In base alla dimensione dello specchio Art. **ORMA**, Art. **VARIO**, Art. **VERTICE** e Art. **FILA** ordinare n°1 Art. **PIASTRA** corrispondente. Vedi la seguente tabella.

*Based upon the measurement of Art. **ORMA**, Art. **VARIO**, Art. **VERTICE** and Art. **FILA** order n°1 Art. **PIASTRA**. See the following chart.*

	L 54	63	72	81	90	99	108	117	126	135	144	153	162	171	180	189	198	207	216	
H										Art. PIASTRA										
50	---	3	3	3	3	1	1	1	1	1	1	1	1	1	1	1	1	1	1	1
75	3	3	3	3	3	1	1	1	1	1	1	2	2	2	2	2	2	2	2	2
90	3	3	3	3	3	1	1	1	1	1	1	2	2	2	2	2	2	2	2	2
100	1	1	1	1	1	1	1	1	1	1	1	2	2	2	2	2	2	2	2	2
110	1	1	1	2	2	2	2	2	2	2	2	2	2	2	2	2	2	2	2	2

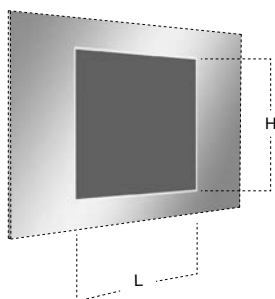

H	L	art.
28	41	24 W 1 PIASTRA1
41	70	60 W 2 PIASTRA2
28	28	16 W 3 PIASTRA3

Sistema riscaldante antiappannamento posizionato al centro per specchiere Art. ORMA, Art. VARIO, Art. VERTICE e Art. FILA.

Anti-fog heating system centered on mirrors Art. ORMA, Art. VARIO, Art. VERTICE and Art. FILA.

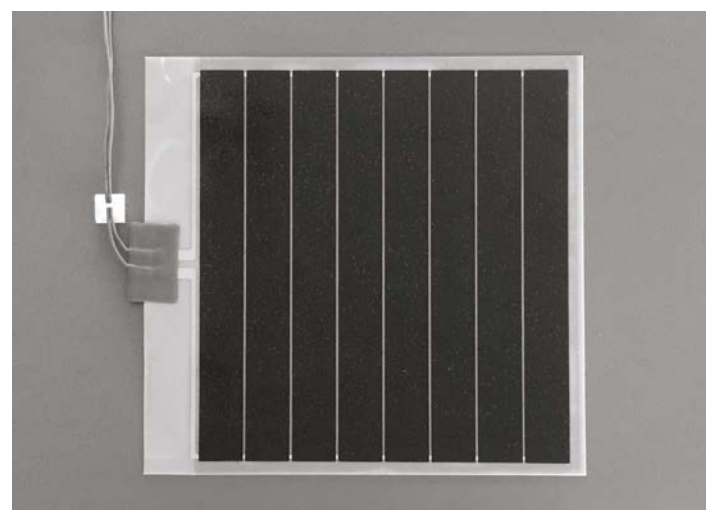





illuminazione a LED 4000 K. Su richiesta illuminazione a LED 3000 K senza maggiorazione di prezzo.

LED lighting 4000 K. Upon request LED lighting 3000 K available without additional surcharge.

* Misure standard / Standard measures

L 54 - 63 - 72 - 81 - 90 - 99 - 108 - 117 - 126 - 135 - 144 - 153 - 162
171 - 180 - 189 - 198 - 207 - 216

P	L	H	art.
2,5	*	50	ORMA50W
		75	ORMA75W
		90	ORMA90W
		110	ORMA110W

Specchio spess. 4 mm a filo lucido con angoli stondati e illuminazione a led luce bianca, completo di telaio.

Polished edge mirror 4 mm thick with rounded corners and white led lighting, with frame.

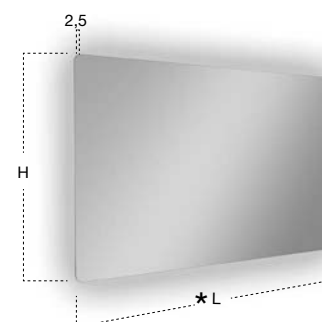





Illuminazione a LED 4000 K. Su richiesta illuminazione a LED 3000 K senza maggiorazione di prezzo.

LED lighting 4000 K. Upon request LED lighting 3000 K available without additional surcharge.

* Misure standard / Standard measures

L 54 - 63 - 72 - 81 - 90 - 99 - 108 - 117 - 126 - 135 - 144 - 153 - 162
171 - 180 - 189 - 198 - 207 - 216

P	L	H	art.
2,5	*	50	VARIO50W
		75	VARIO75W
		90	VARIO90W
		100	VARIO100W
		110	VARIO110W

Specchio spess. 4 mm a filo lucido con illuminazione a led, luce bianca completo di telaio.

Polished edge mirror 4 mm thick with white led lighting and frame.

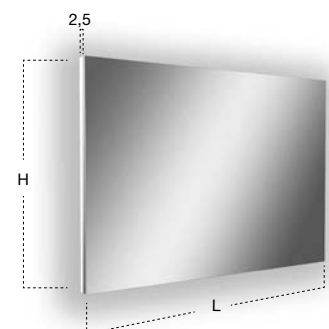

VERTICE

_2016

design
AL Studio

Rimanda all'immagine di un quadro, per via di una fascia perimetrale sabbiata di 3 cm con illuminazione a led che racchiude la superficie specchiante. Vertice è la specchiera con vetro argentato dello spessore di 4 mm sostenuta da un telaio di alluminio nero che grazie a una preziosa cornice luminosa mette in scena il racconto quotidiano dell'ambiente bagno, inquadrando protagonisti e colori.

It reminds to a painting thanks to a 3 cm perimetral sandblasted frame equipped with led-lighting. Vertice is a 4 mm thick mirror sustained by a black aluminum structure and a precious bright frame reflecting everyday life in bath.





Illuminazione a LED 4000 K. Su richiesta illuminazione a LED 3000 K senza maggiorazione di prezzo.

LED lighting 4000 K. Upon request LED lighting 3000 K available without additional surcharge.

P	L	H	art.
2,5	da / from 72 a / to 216	75	VERTICE75W
		90	VERTICE90W

Specchio spess. 4 mm a filo lucido con illuminazione a led luce bianca, completo di telaio nero.

Polished edge mirror 4 mm thick with white led lighting, complete with black frame.

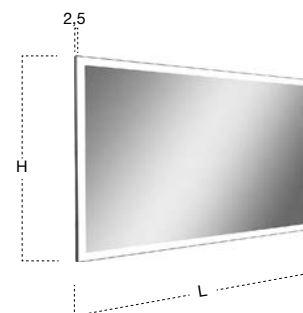

FILA

_2016

design
AL Studio

Una doppia cornice, una specchiante e una luminosa, a evidenziare il perimetro della superficie, a sottolineare l'importanza delle immagini che vi si riflettono. File è una specchiera con vetro spessore 4 mm e fascia perimetrale sabbiata di 1,5 cm con illuminazione a led. È sostenuta da un telaio portante in alluminio nero che conferisce eleganza all'insieme.

A double frame, a reflecting one and a bright one, enhancing the surface perimeter. File is a 4 mm thick mirror with a 1,5 cm sandblasted perimetral frame equipped with led-lighting. It has a black aluminum structure that lends elegance to the context.





illuminazione a LED 4000 K. Su richiesta illuminazione a LED 3000 K senza maggiorazione di prezzo.

LED lighting 4000 K. Upon request LED lighting 3000 K available without additional surcharge.

P	L	H	art.
2,5	da / from 72 a / to 216	75	FILA75W
		90	FILA90W

Specchio spess. 4 mm a filo lucido con illuminazione a led luce bianca, completo di telaio nero.

Polished edge mirror 4 mm thick with white led lighting, complete with black frame.

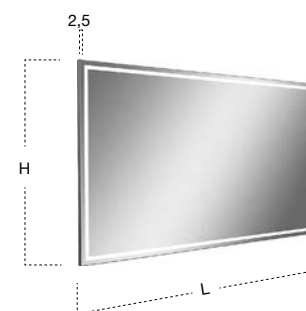

APICE

_2014

design
AL Studio



Essenziale e minimale, Apice è la specchiera con vetro argentato dello spessore 4 mm priva di bordo, disponibile con o senza illuminazione a led. L'immagine nitida e assoluta viene impreziosita da un inserto argentato bronzo o fumè che divide in due parti la superficie conferendo dinamismo all'insieme. Un segno che rompe gli equilibri statici della composizione e ne scalfisce la perfezione geometrica, aggiungendo valore alla forma.

Essential and minimal, Apice is a 4 mm thick mirror without edges, available with or without led-lighting. The crisp image is embellished by a bronze or fume mirrored section that divides into two parts the surface conferring dynamism to the context. A sign that breaks the static equilibriums of the composition, adding value to the shape.



illuminazione a LED 4000 K. Su richiesta illuminazione a LED 3000 K senza maggiorazione di prezzo.

LED lighting 4000 K. Upon request LED lighting 3000 K available without additional surcharge.

P	L	H	art.	art.
2,5	da / from 90	a / to 216	50	APICE50 APICE50W Con illuminazione a led / With led lighting

Specchio spess. 4 mm a filo lucido con o senza illuminazione a led luce bianca e inserto argentato fumé o bronzo, completo di telaio nero.

Polished edge mirror 4 mm thick with or without white led lighting and fumé or bronze silvered insert, complete with black frame.

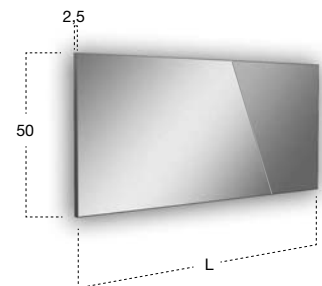

LUCENTE

_2017

design
AL Studio

illuminazione a led diretta

direct led lighting





illuminazione a led indiretta

indirect led lighting

Compatibile solo con specchiere NEUTRO e NEUTROLED. Per applicazione su specchi NEUTROLED, occorre inserirla ad una distanza minima dal bordo superiore di 9 cm.
Non compatibile con specchiere NEUTROLED H 50 cm.

*Compatible only with NEUTRO and NEUTROLED mirrors. For an application on NEUTROLED mirrors it must be installed at a minimum distance from the upper border of 9 cm.
Not compatible with NEUTROLED mirrors H 50 cm.*





Lampada in alluminio verniciato nero con illuminazione a led diretta e indiretta, cover in vetro argentato
 N.B. Per applicazione su specchi NEUTROLED, occorre inserirla ad una distanza minima dal bordo superiore di 9 cm. Non compatibile con specchiere NEUTROLED H 50 cm.

*Black lacquered aluminum lamp with direct and indirect led-lighting, cover in silvered glass
 P.S. For an application on NEUTROLED mirrors it must be installed at a minimum distance from the upper border of 9 cm. Not compatible with NEUTROLED mirrors H 50 cm.*

Illuminazione a LED 4000 K. Su richiesta illuminazione a LED 3000 K senza maggiorazione di prezzo.

LED lighting 4000 K. Upon request LED lighting 3000 K available without additional surcharge.

Per mercato USA e Canada
 For US and Canadian markets

P	H	* L	art.	art.	
4,5	9	45	LUCENTE45	LUCENTES45	12,96 W
		54	LUCENTE54	LUCENTES54	15,55 W
		63	LUCENTE63	LUCENTES63	18,14 W
		72	LUCENTE72	LUCENTES72	20,75 W
		81	LUCENTE81	LUCENTES81	23,35 W
		90	LUCENTE90	LUCENTES90	25,95 W
		99	LUCENTE99	LUCENTES99	28,54 W
		108	LUCENTE108	LUCENTES108	31,14 W
		117	LUCENTE117	LUCENTES117	33,73 W
		126	LUCENTE126	LUCENTES126	36,32 W
		135	LUCENTE135	LUCENTES135	38,92 W
		144	LUCENTE144	LUCENTES144	41,51 W
		153	LUCENTE153	LUCENTES153	44,10 W
		162	LUCENTE162	LUCENTES162	46,70 W
		171	LUCENTE171	LUCENTES171	49,29 W
		180	LUCENTE180	LUCENTES180	51,89 W
		189	LUCENTE189	LUCENTES189	54,48 W
		198	LUCENTE198	LUCENTES198	57,08 W
		207	LUCENTE207	LUCENTES207	59,67 W
		216	LUCENTE216	LUCENTES216	62,27 W

* Misure standard / Standard measures

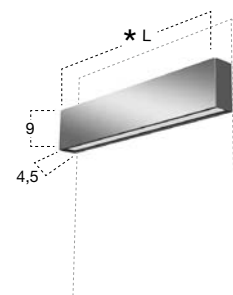





Illuminazione a LED 4000 K. Su richiesta illuminazione a LED 3000 K senza maggiorazione di prezzo.

LED lighting 4000 K. Upon request LED lighting 3000 K available without additional surcharge.

Ø	L	ART.
90	112,5	CIRCUS190W
108	135	CIRCUS1108W

Specchio spess. 5 mm a filo lucido con illuminazione a led luce bianca, completo di telaio e lampada LUCENTE versione dx o sx.

Polished edge mirror 5 mm thick with white led lighting, complete with frame and lamp art. LUCENTE, right or left hand version.

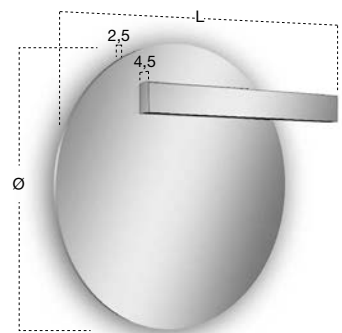

Versione dx

Right version

459



illuminazione a LED 4000 K. Su richiesta illuminazione a LED 3000 K senza maggiorazione di prezzo.

LED lighting 4000 K. Upon request LED lighting 3000 K available without additional surcharge.

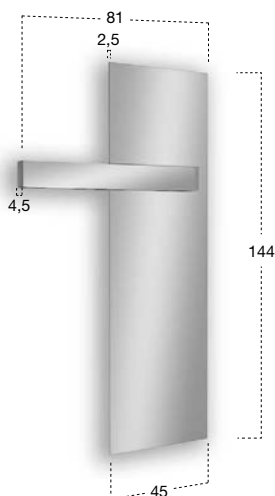

Versione sx

Left version

460

H	L	ART.
144	81	NEOLUCE1

Specchio spess. 5 mm a filo lucido con illuminazione a led luce bianca, completo di telaio e lampada LUCENTE versione dx o sx.

Polished edge mirror 5 mm thick with white led lighting complete with frame and lamp LUCENTE, right or left hand version.



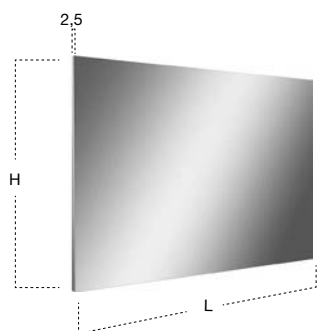

P	L	H	art.
2,5	da / from 54 a / to 216	50	NEUTRO50
		75	NEUTRO75
		90	NEUTRO90
		100	NEUTRO100
		110	NEUTRO110

Specchio spess. 5 mm a filo lucido orizzontale o verticale, completo di telaio nero.

Polished edge mirror 5 mm thick mounted horizontally or vertically, complete with black frame.



Illuminazione a LED 4000 K. Su richiesta illuminazione a LED 3000 K senza maggiorazione di prezzo.

LED lighting 4000 K. Upon request LED lighting 3000 K available without additional surcharge.

P	L	H	art.
2,5	da / from 54 a / to 216	50	NEUTROLED50W
		75	NEUTROLED75W
		90	NEUTROLED90W
		100	NEUTROLED100W
		110	NEUTROLED110W
		125	NEUTROLED125W
		142	NEUTROLED142W

Specchio spess. 5 mm a filo lucido orizzontale o verticale con illuminazione a led luce bianca, completo di telaio.

Polished edge mirror 5 mm thick mounted horizontally or vertically with white led lighting complete with frame.

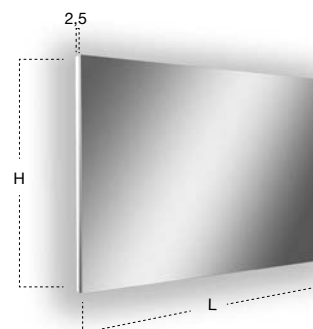





Illuminazione a LED 4000 K. Su richiesta illuminazione a LED 3000 K senza maggiorazione di prezzo.

LED lighting 4000 K. Upon request LED lighting 3000 K available without additional surcharge.

P	L	H	art.
2,5	45	144	NEUTRO1144W45
	45	180	NEUTRO1180W45

Specchio spess. 5 mm a filo lucido con illuminazione a led luce bianca, completo di telaio.

Polished edge mirror 5 mm thick with white led lighting, complete with frame.

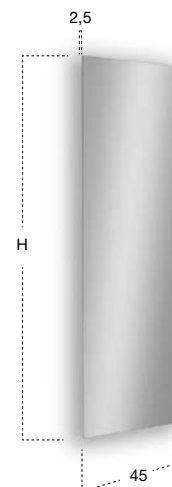



Illuminazione a LED 4000 K. Su richiesta illuminazione a LED 3000 K senza maggiorazione di prezzo.

LED lighting 4000 K. Upon request LED lighting 3000 K available without additional surcharge.

P	L	H	art.
2,5	54	210	NEUTRO210W54
	72	210	NEUTRO210W72
	90	210	NEUTRO210W90

Specchio spess. 5 mm a filo lucido con illuminazione a led luce bianca, completo di telaio.

Polished edge mirror 5 mm thick with white led lighting, complete with frame.

P	L	H	art.
2,5	54	210	NTKIT210W54
	72	210	NTKIT210W72
	90	210	NTKIT210W90

Specchio spess. 5 mm a filo lucido con illuminazione a led luce bianca, completo di telaio predisposto per corpo ad incasso Art. SP201INSA, Art. SP201INLU.

Polished edge mirror 5 mm thick complete with frame and white led lighting prepared for concealed valves Art. SP201INSA, Art. SP201INLU.

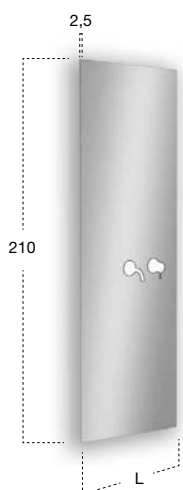



Illuminazione a LED 4000 K. Su richiesta illuminazione a LED 3000 K senza maggiorazione di prezzo.

LED lighting 4000 K. Upon request LED lighting 3000 K available without additional surcharge.

P	L	H	art.
2,5	da / from 54 a / to 216	50	NTKIT50W
		75	NTKIT75W
		90	NTKIT90W
		100	NTKIT100W
		110	NTKIT110W
		125	NTKIT125W
		142	NTKIT142W

Specchio spess. 5 mm a filo lucido orizzontale o verticale con illuminazione a led luce bianca, completo di telaio predisposto per corpo ad incasso Art. SP201INSA, Art. SP201INLU e/o porta salviette RETTA.

Polished edge mirror 5 mm thick mounted horizontally or vertically complete with frame and white led lighting prepared for concealed valves Art. SP201INSA, Art. SP201INLU and/or towel rail Art. RETTA.

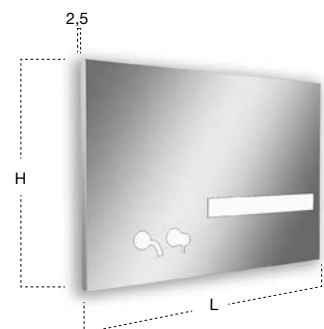

NEUTROLED (A) + NEUTROKIT (B)

Esempi di possibili composizioni con specchiere
art. NEUTROLED (A) e art. NEUTROKIT (B).

*Examples of possible compositions with mirrors
art. NEUTROLED (A) and art. NEUTROKIT (B).*









Illuminazione a LED 4000 K. Su richiesta illuminazione a LED 3000 K senza maggiorazione di prezzo.

LED lighting 4000 K. Upon request LED lighting 3000 K available without additional surcharge.

P	L	H	art.
4	da / from 72 a / to 216	50	FLASH50W
		75	FLASH75W
		90	FLASH90W
		100	FLASH100W

 Per mercato USA e Canada
For US and Canadian markets

P	L	H	art.
4	da / from 72 a / to 216	50	FLASH050S
		75	FLASH075S
		90	FLASH090S
		100	FLASH100W

Specchio spess. 5 mm a filo lucido con illuminazione a led luce bianca, completo di telaio in acciaio lucido AISI 304.

N.B. Su richiesta è possibile avere illuminazione a led bianca e blu.

Polished edge mirror 5 mm thick with white led lighting, complete with polished steel frame AISI 304.
P.S. Upon request it is possible to have white and blue led lighting.

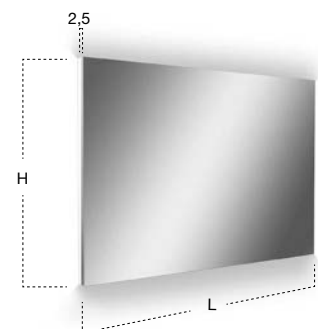



illuminazione a LED 4000 K. Su richiesta illuminazione a LED 3000 K senza maggiorazione di prezzo.

LED lighting 4000 K. Upon request LED lighting 3000 K available without additional surcharge.

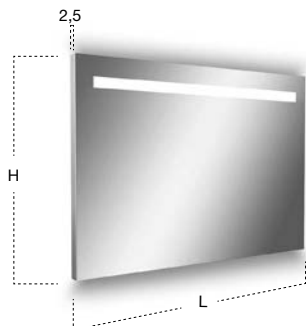

P	L	H	art.
4	da / from 72 a / to 216	50	SPIO650W
		75	SPIO675W
 Per mercato USA e Canada For US and Canadian markets			
P	L	H	art.
4	da / from 72 a / to 216	50	LAMP0050S
		75	LAMP0075S

Specchio spess. 5 mm a filo lucido con illuminazione a led luce bianca, completo di telaio in acciaio lucido AISI 304.

N.B. Su richiesta è possibile avere illuminazione a led bianca e blu.

Polished edge mirror 5 mm thick with white led lighting, complete with polished steel frame AISI 304.
P.S. Upon request it is possible to have white and blue led lighting.



illuminazione a LED 4000 K. Su richiesta illuminazione a LED 3000 K senza maggiorazione di prezzo.

LED lighting 4000 K. Upon request LED lighting 3000 K available without additional surcharge.

P	L	H	art.
4	da / from 72 a / to 216	50	SPIO150W
		75	SPIO175W
 Per mercato USA e Canada For US and Canadian markets			
P	L	H	art.
4	da / from 72 a / to 216	50	SPIO1050S
		75	SPIO1075S

Specchio spess. 5 mm a filo lucido con illuminazione a led luce bianca, completo di telaio in acciaio lucido AISI 304.

N.B. Su richiesta è possibile avere illuminazione a led bianca e blu.

Polished edge mirror 5 mm thick with white led lighting, complete with polished steel frame AISI 304.
P.S. Upon request it is possible to have white and blue led lighting.

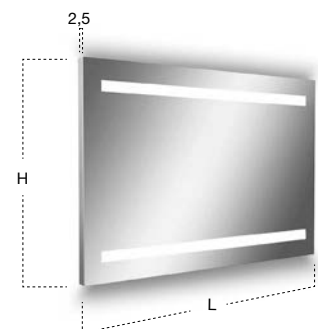



illuminazione a LED 4000 K. Su richiesta illuminazione a LED 3000 K senza maggiorazione di prezzo.

LED lighting 4000 K. Upon request LED lighting 3000 K available without additional surcharge.

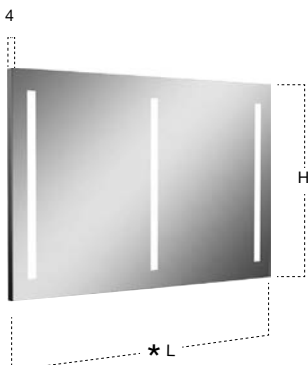

* Misure standard / Standard measures

L 90 - 99 - 108 - 117 - 126 - 135 - 144 - 153 - 162
171 - 180 - 189 - 198 - 207 - 216

P	L	H	art.
4	*	50	SPIO250W
		75	SPIO275W



P	L	H	art.
4	*	50	SPIO2050W
		75	SPIO2075W

Specchio spess. 5 mm a filo lucido con illuminazione a led luce bianca completo di telaio in acciaio lucido AISI 304.

Polished edge mirror 5 mm thick with white led lighting complete with polished stainless steel frame AISI 304.



illuminazione a LED 4000 K. Su richiesta illuminazione a LED 3000 K senza maggiorazione di prezzo.

LED lighting 4000 K. Upon request LED lighting 3000 K available without additional surcharge.

Versione sx / Left version

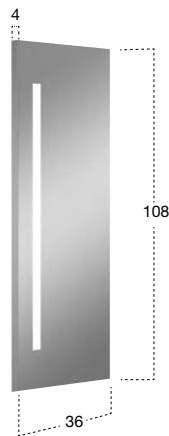

illuminazione a LED 4000 K. Su richiesta illuminazione a LED 3000 K senza maggiorazione di prezzo.

LED lighting 4000 K. Upon request LED lighting 3000 K available without additional surcharge.

Versione dx / Right version

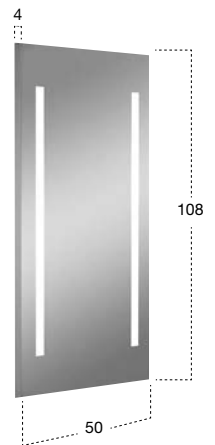

P	L	H	art.
4	36	108	SPIO4W

 Per mercato USA e Canada
For US and Canadian markets

P	L	H	art.
4	36	108	SPIO4S

Specchio spess. 5 mm dx o sx a filo lucido con illuminazione a led luce bianca completo di telaio in acciaio lucido AISI 304.

Polished edge mirror 5 mm thick, right or left, with white led lighting complete with polished stainless steel frame AISI 304.

P	L	H	art.
4	50	108	SPIO5W

 Per mercato USA e Canada
For US and Canadian markets

P	L	H	art.
4	50	108	SPIO5S

Specchio spess. 5 mm a filo lucido con illuminazione a led luce bianca completo di telaio in acciaio lucido AISI 304.

Polished edge mirror 5 mm thick with white led lighting complete with polished stainless steel frame AISI 304.



illuminazione a LED 4000 K. Su richiesta illuminazione a LED 3000 K senza maggiorazione di prezzo.

LED lighting 4000 K. Upon request LED lighting 3000 K available without additional surcharge.

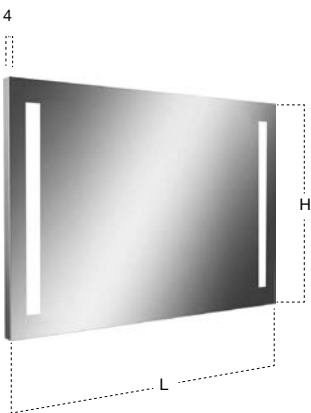

* Misure standard / Standard measures

L 72 - 81 - 90 - 99 - 108 - 117 - 126 - 135 - 144 - 153 - 162
171 - 180 - 189 - 198 - 207 - 216

P	L	H	art.
4	*	50	SPIO750W
		75	SPIO775W

 Per mercato USA e Canada
For US and Canadian markets

P	L	H	art.
4	*	50	SPIO050S
		75	SPIO075S

Specchio spess. 5 mm a filo lucido con illuminazione a led luce bianca completo di telaio in acciaio lucido AISI 304.

Polished edge mirror 5 mm thick with white led lighting complete with polished stainless steel frame AISI 304.

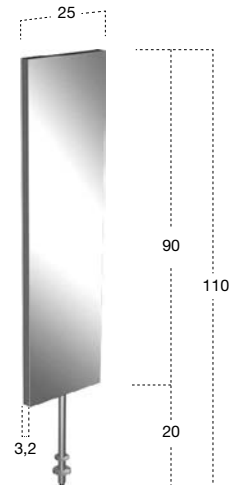
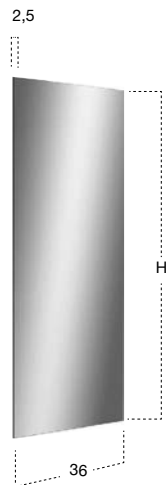

P	L	H	art.
2,5	36	90	SLOW1
		108	SLOW2

P	L	H	art.
3,2	25	110	ALTEREGO

Specchio spess. 5 mm girevole bifacciale con struttura in acciaio inox satinato AISI 304.

Double faced revolving mirror 5 mm thick with satin stainless steel structure AISI 304.

Specchio spess. 5 mm a filo lucido.

Polished edge mirror 5 mm thick.



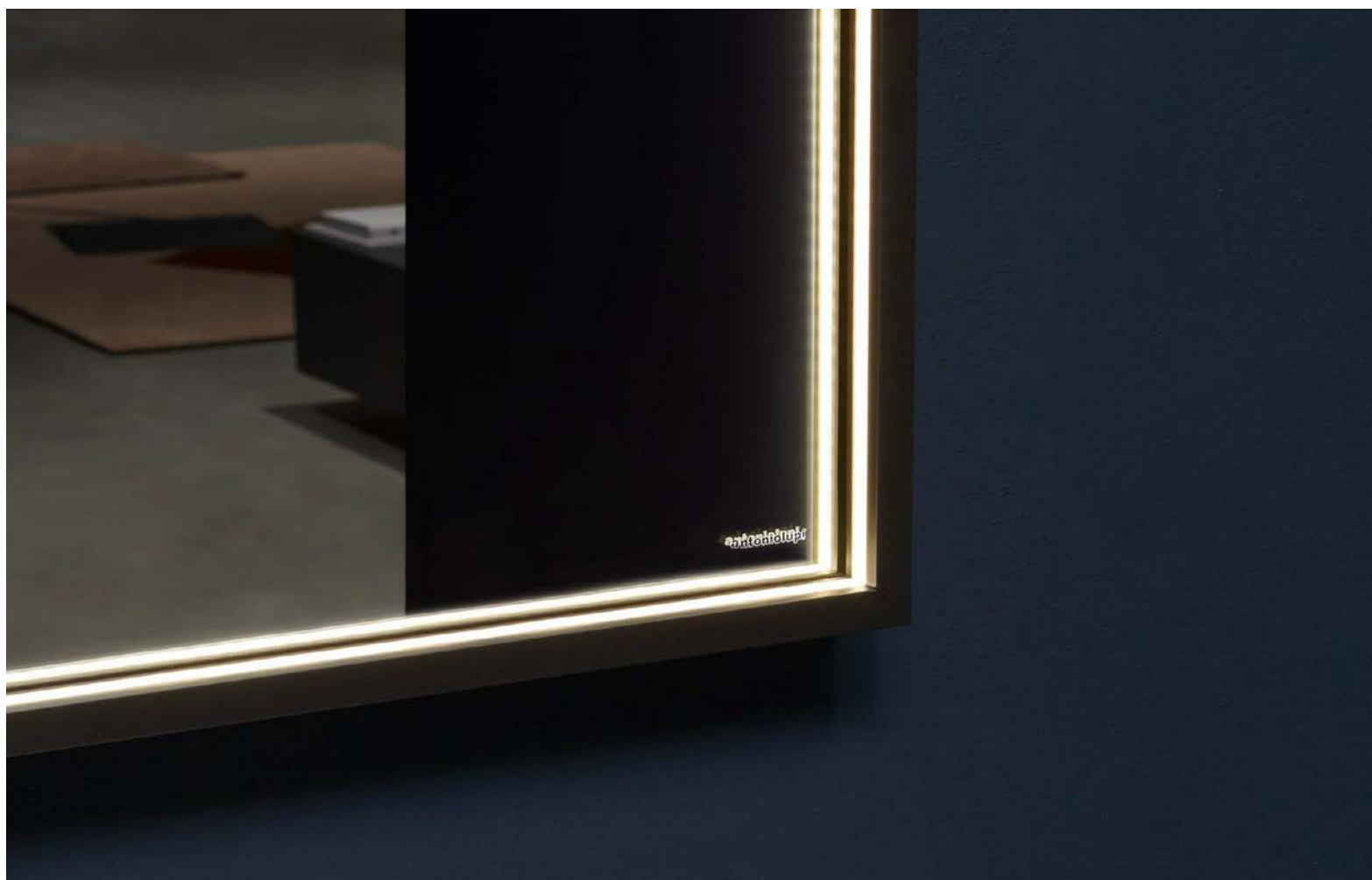

Come un quadro, un'opera d'arte, un segno rigoroso che nasce da una geometria perfetta e racchiude una o più immagini in movimento. Un perimetro preciso ma allo stesso tempo capace di suscitare emozione e sorpresa. È elegante e raffinata la cornice in alluminio finitura bronzo, che caratterizza lo specchio Edison. La luce integrata nella cornice è l'assoluta protagonista di questo sistema e definisce una delle aree più importanti della stanza da bagno conferendogli raffinatezza e fascino. Edison è disponibile in diverse dimensioni e quando è acceso conferisce un'aura magica a tutto l'ambiente.

Like a painting, a work of art, a rigorous sign that comes from perfect geometry and contains one or more moving images. A precise perimeter but at the same time capable of arousing emotion and surprise. The bronze finish aluminum frame, which characterizes the Edison mirror, is elegant and refined. The light integrated into the frame is the absolute protagonist of this system and defines one of the most important areas of the bathroom giving it refinement and charm. Edison is available in different sizes and when lit it gives a magical aura to the entire environment.

Illuminazione a LED 4000 K. Su richiesta illuminazione a LED 3000 K senza maggiorazione di prezzo.

LED lighting 4000 K. Upon request LED lighting 3000 K available without additional surcharge.

P	L	H	art.
5,4	da / from 54 a / to 216	50	EDISON50W
5,4	da / from 54 a / to 216	75	EDISON75W

Specchio spess. 4 mm a filo lucido orizzontale o verticale con cornice in alluminio finitura bronzo con illuminazione a led luce bianca.

Horizontal or vertical mirror 4 mm thick with bronze aluminum frame and white led lighting.

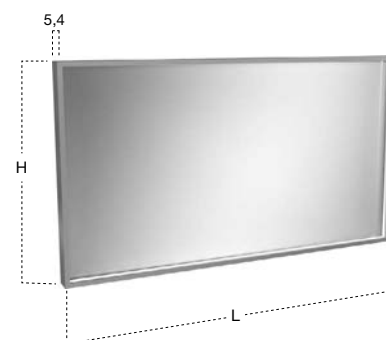



Negli specchi la luce diffusa è molto bella esteticamente e soprattutto rilassante, ma non illumina il viso, quindi per radersi o truccarsi, occorre un altro tipo d'illuminazione. BOLLA è nata per risolvere questo problema, con la sua luce morbida e diretta, posta in alto al centro o al lato dello specchio, illumina il viso uniformemente.

A scattered light is aesthetically very beautiful and relaxing when shined upon mirrors however it doesn't illuminate the face, for shaving or putting on make-up you need another type of lighting. BOLLA is born to resolve this issue with its soft yet direct light placed high in the center or to the side of the mirror illuminates the face evenly.



Ø art.

8 BOLLA

Lampada a led da specchio in vetro pyrex con supporto in alluminio, completa di lampada e trasformatore.

Led lamp in pyrex glass with aluminum support, complete with bulb and transformer.



Ø	art.
8	BOLLA2

Coppia di lampade a led da specchio in vetro pyrex con supporto in alluminio, complete di lampada e trasformatore.

Pair of led lamps in pyrex glass with aluminum support, complete with bulb and transformer.







Ø	art.
12	BOLLA1

Lampada da specchio e da parete in vetro pyrex con supporto in alluminio completa di lampada.

Mirror or wall lamp in pyrex glass with aluminum support, complete with bulb.







illuminazione a LED 4000 K. Su richiesta illuminazione a LED 3000 K senza maggiorazione di prezzo.

LED lighting 4000 K. Upon request LED lighting 3000 K available without additional surcharge.

P	L	H	art.	art.
4,2	da / from 54	a / to 216	50	BSK50 BSK50W Con illuminazione a led / With led lighting
			75	BSK75 BSK75W Con illuminazione a led / With led lighting
			90	BSK90 BSK90W Con illuminazione a led / With led lighting
			100	BSK100 BSK100W Con illuminazione a led / With led lighting
			110	BSK110 BSK110W Con illuminazione a led / With led lighting

Specchio spess. 4 mm a filo lucido orizzontale o verticale e cornice in alluminio finitura come da nostro campionario colori, con o senza illuminazione a led.

Horizontal or vertical polished edge mirror 4 mm thick and aluminum frame finish as per our colour samples, with or without led lighting

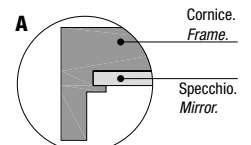
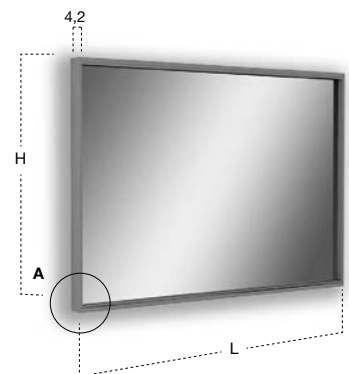



illuminazione a LED 4000 K. Su richiesta illuminazione a LED 3000 K senza maggiorazione di prezzo.

LED lighting 4000 K. Upon request LED lighting 3000 K available without additional surcharge.

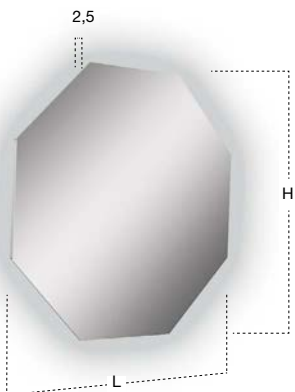

P	L	H	art.	art.
2,5	72	72	MODULO872	MODULO872W Con illuminazione a led / With led lighting
	90	90	MODULO890	MODULO890W Con illuminazione a led / With led lighting
	108	108	MODULO8108	MODULO8108W Con illuminazione a led / With led lighting

Specchio spess. 5 mm a filo lucido con o senza illuminazione a led luce bianca, completo di telaio.

Polished edge mirror 5 mm thick with or without white led lighting, complete with frame.

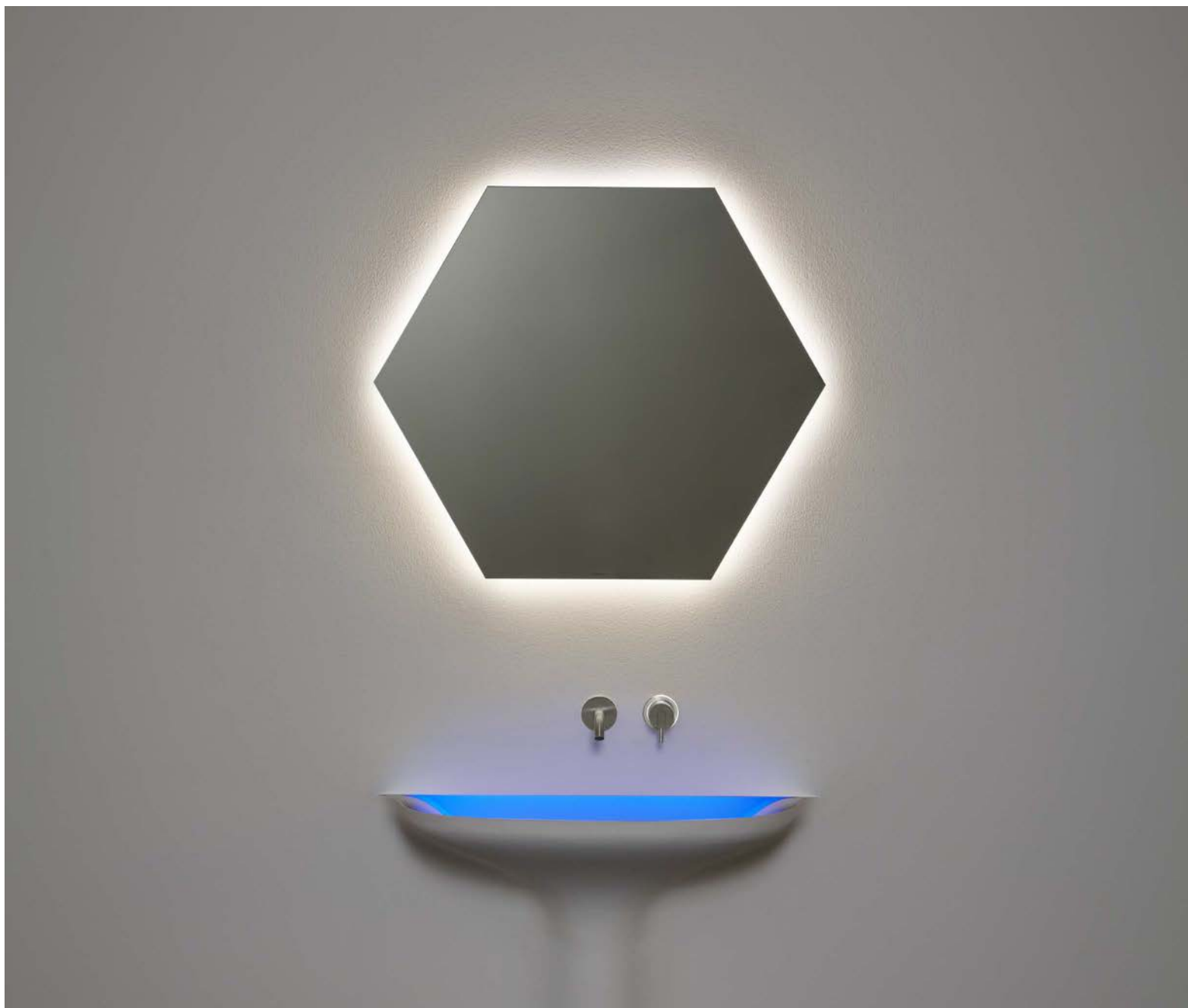

illuminazione a LED 4000 K. Su richiesta illuminazione a LED 3000 K senza maggiorazione di prezzo.

LED lighting 4000 K. Upon request LED lighting 3000 K available without additional surcharge.

P	L	H	art.	art.
2,5	72	62	MODULO672	MODULO672W Con illuminazione a led / With led lighting
	90	78	MODULO690	MODULO690W Con illuminazione a led / With led lighting
	108	94	MODULO6108	MODULO6108W Con illuminazione a led / With led lighting

Specchio spess. 5 mm a filo lucido con o senza illuminazione a led luce bianca, completo di telaio.

Polished edge mirror 5 mm thick with or without white led lighting, complete with frame.

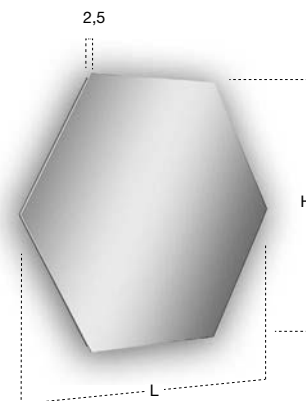





illuminazione a LED 4000 K. Su richiesta illuminazione a LED 3000 K senza maggiorazione di prezzo.

LED lighting 4000 K. Upon request LED lighting 3000 K available without additional surcharge.

CORNICE (La realizzazione della cornice è a cura del cliente)
FRAME (frame not included)

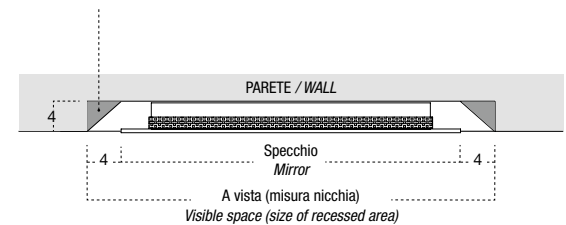

P	L	H	art.
4	da / from 64 a / to 208	42	PERIPLO

Specchio spess. 5 mm a filo lucido orizzontale o verticale con illuminazione a led luce bianca, da incasso a parete.

Encased wall mount polished edge mirror 5 mm thick with white led lighting, mounted horizontally or vertically.

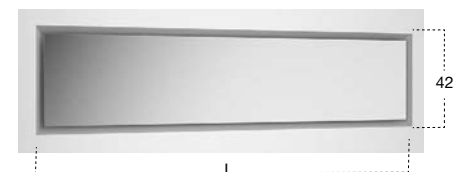





illuminazione a LED 4000 K. Su richiesta illuminazione a LED 3000 K senza maggiorazione di prezzo.

LED lighting 4000 K. Upon request LED lighting 3000 K available without additional surcharge.

P	L	H	art.	art.
4,2	54	210	BSK21054	BSK210W54 Con illuminazione a led / With led lighting
	72	210	BSK21072	BSK210W72 Con illuminazione a led / With led lighting
	90	210	BSK21090	BSK210W90 Con illuminazione a led / With led lighting

Specchio spess. 4 mm a filo lucido orizzontale o verticale e cornice in alluminio finitura come da nostro campionario colori, con o senza illuminazione a led.

Horizontal or vertical polished edge mirror 4 mm thick and aluminum frame finish as per our colour samples, with or without led lighting

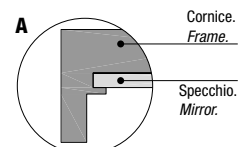
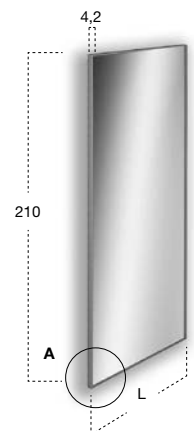





P	L	H	art.
4	180	220	DAMONE

Specchio spess. 5 mm a filo lucido con cornice a disegno completo di telaio laccato nero gofrato.

Polished edge mirror 5 mm thick complete with lacquered frame embossed black.

MANTRA

N.B. È possibile inserire 1 lampada a led superiore e 1 lampada a led inferiore.

P.S. It is possible to insert 1 led light above and 1 led light below.





Art. PRESA / PRESACH

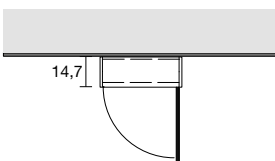
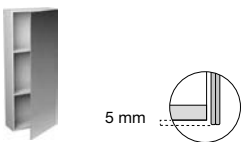

a Pensile a parete
Wall cabinet

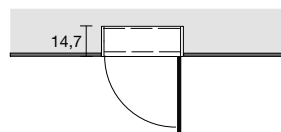
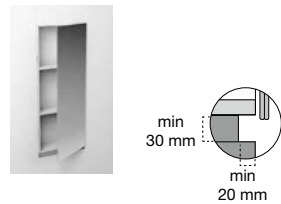

b Pensile incassato a parete
Encased wall cabinet



N. 2 prese di corrente per pensili.

N. 2 electrical sockets for wall cabinets.

P	L	H	art.
14,7	36/45/54	50	MANTRA150
		75	MANTRA175
		90	MANTRA190

Pensile dx o sx con 1 anta a specchio bifacciale e 1 ripiano interno per H 50 cm o 2 ripiani interni per H 75 e H 90 cm.

Right or left wall cabinet with 1 double face mirrored door and 1 internal shelf for H 50 cm or with 2 internal shelves for H 75 and H 90 cm.

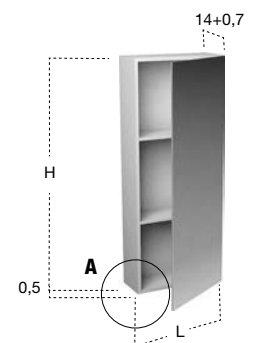
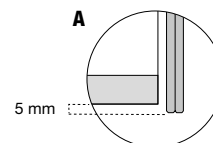





Art. PRESA / PRESACH

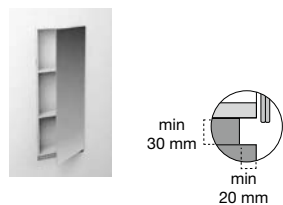
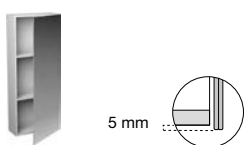

N. 2 prese di corrente per pensili.

N. 2 electrical sockets for wall cabinets.

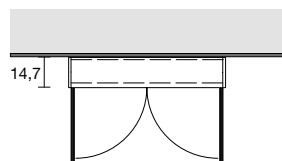

a Pensile a parete
Wall cabinet

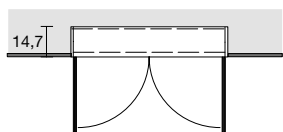

b Pensile incassato a parete
Encased wall cabinet

P	L	H	art.
14,7	72/90/108	50	MANTRA250
		75	MANTRA275
		90	MANTRA290

Pensile con 2 ante a specchio bifacciali e 1 ripiano interno per H 50 cm o 2 ripiani interni per H 75 e H 90 cm.

Wall cabinet with 2 double face mirrored door and 1 internal shelf for H 50 cm or with 2 internal shelves for H 75 and H 90 cm.

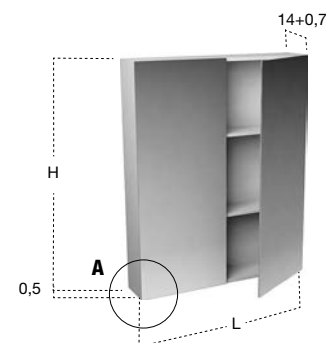
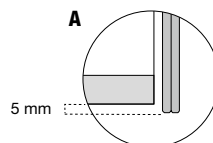



Su richiesta è possibile inserire all'interno dell'anta un secondo specchio.

On request it is possible to insert a second mirror on the inside of the door front.



P	L	H	art.
21,6	36	37,5	KE1136
	45	37,5	KE1145

P	L	H	art.
21,6	72	37,5	KE3172
	90	37,5	KE3190

P	L	H	art.
21,6	36	50	KE1436
	45	50	KE1445
	54	50	KE1454

P	L	H	art.
21,6	72	50	KE3472
	90	50	KE3490
	108	50	KE34108

Pensile con 1 o 2 ante e 1 ripiano interno solo per H 50 cm.

Wall cabinet with 1 or 2 doors and 1 internal shelf for H 50 cm.

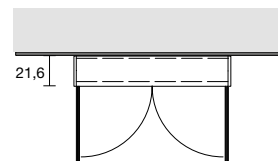

a Pensile a parete
Wall cabinet

Art. KE1136 / KE1145
Versione sx / Left version

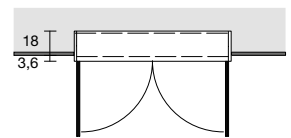

b Pensile semincasso a parete
Semi-encased wall cabinet

Art. KE3172 / KE3190

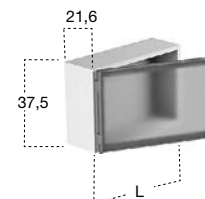

Art. KE1436 / KE1445 / KE1454
Versione sx / Left version

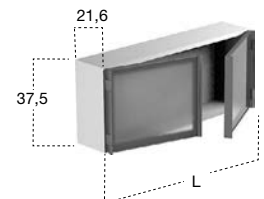

Art. KE3472 / KE3490 / KE34108

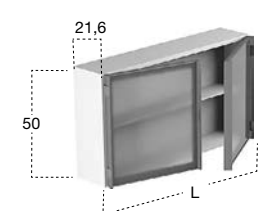
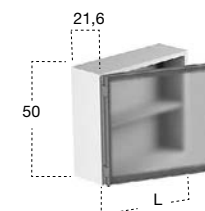

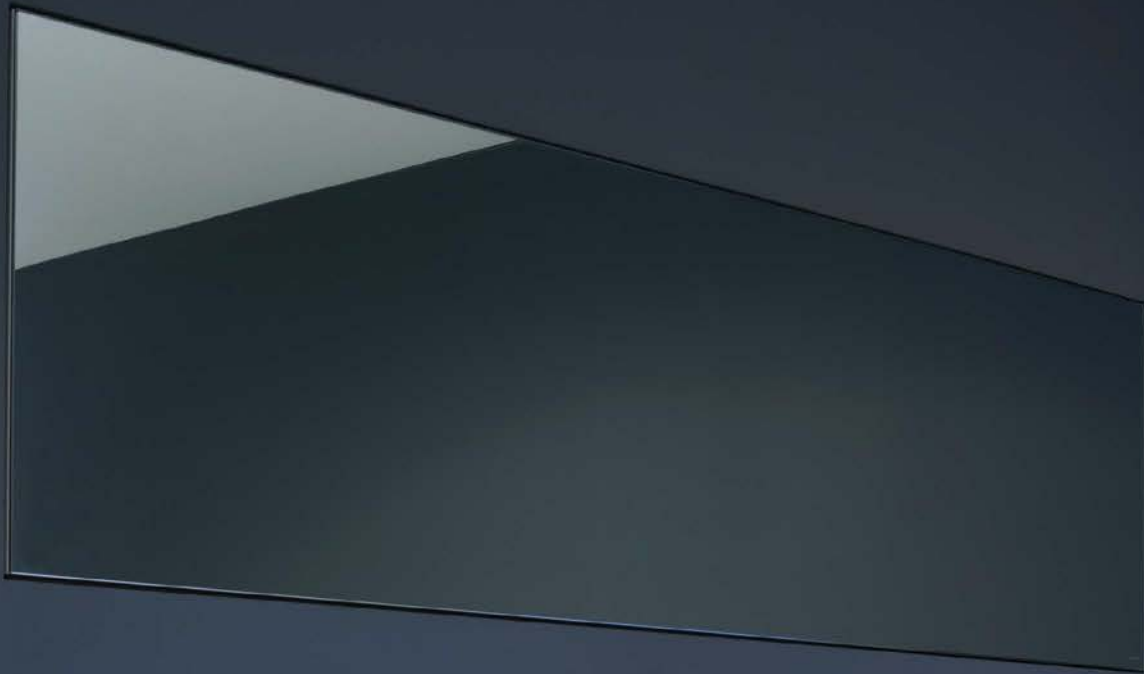

N.B. Da L 72 a L 108 cm è possibile inserire 1 lampada,
da L 117 a L 216 cm è possibile inserire 2 lampade a led.

*P.S. From L 72 to L 108 cm it's possible to use 1 light, from L
117 to L 216 cm it's possible to use 2 led lights.*

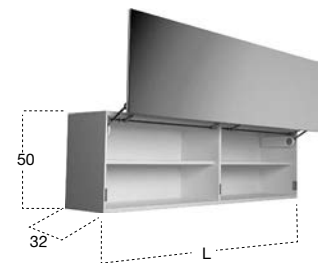

Specchio.
Mirror.

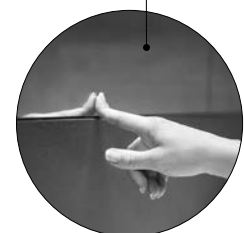

P	L	H	art.
32	da / from 72 a / to 216	50	SEGRETO

Pensile con anta a specchio ad apertura verticale, mediante sistema elettrico con possibile inserimento di illuminazione a led.

Wall cabinet with vertical electrical flap-opening door. Upon request it can be produced with internal led lighting.





TEATRO

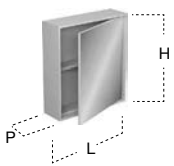

P	L	H	art.
14	27/36/45/54	50	TEATRO15014
		75	TEATRO17514
		100	TEATRO10014
		125	TEATRO12514

P	L	H	art.
22	27/36/45/54	50	TEATRO15022
		75	TEATRO17522
		100	TEATRO10022
		125	TEATRO12522

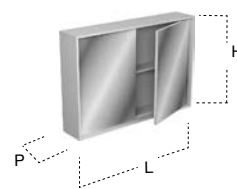

P	L	H	art.
14	54/72/90/108	50	TEATRO25014
		75	TEATRO27514

P	L	H	art.
22	54/72/90/108	50	TEATRO25022
		75	TEATRO27522

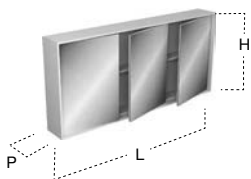

P	L	H	art.
14	81/108/135/162	50	TEATRO35014
		75	TEATRO37514

P	L	H	art.
22	81/108/135/162	50	TEATRO35022
		75	TEATRO37522

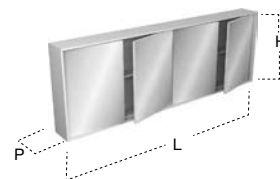

P	L	H	art.
14	108/144/180/216	50	TEATRO45014
		75	TEATRO47514

P	L	H	art.
22	108/144/180/216	50	TEATRO45022
		75	TEATRO47522

Versione sx / Left version

N.B. È possibile inserire 1 lampada a led superiore.
 P.S. It is possible to insert 1 led light above.



1 Prof. 14 cm / 14 cm D.

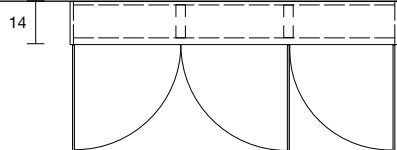

1a Pensile a parete
 Wall cabinet

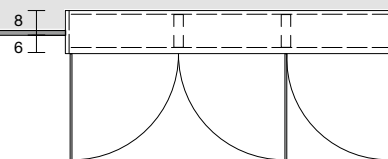

1b Pensile semincassato a parete
 Semi-encased wall cabinet

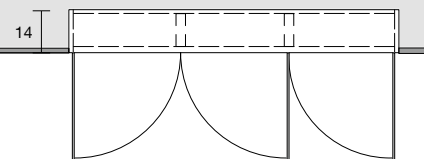

1c Pensile incassato a parete
 Encased wall cabinet

2 Prof. 22 cm / 22 cm D.

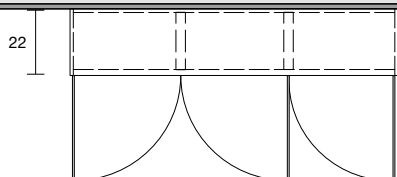

2a Pensile a parete
 Wall cabinet

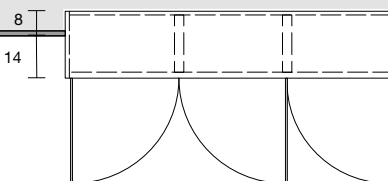

2b Pensile semincassato a parete
 Semi-encased wall cabinet

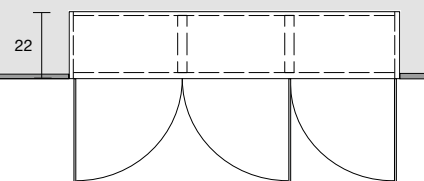

2c Pensile incassato a parete
 Encased wall cabinet

Pensile con anta a specchio bifacciale.

Wall cabinet with double face mirrored door.





LUXOR

cristallo argentato rosé / rosé silvered glass





LUXOR

cristallo argentato bronzo / bronze silvered glass





LUXOR

cristallo argentato fumé / *fumé silvered glass*





Specchio spess. 5 mm tondo molato.

Beveled round mirror 5 mm thick.

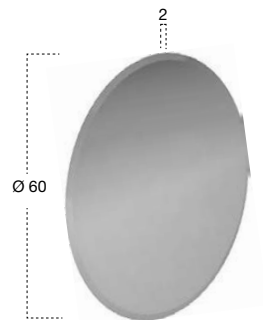

P	Ø	art.	
2	60	LUXOR1	

Specchio spess. 5 mm quadrato molato.

Beveled square mirror 5 mm thick.

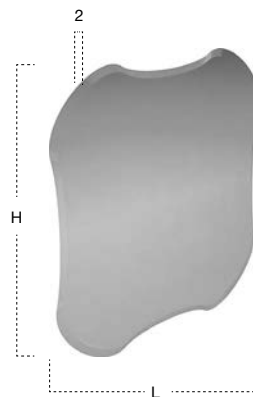

P	L	H	art.
2	75	75	LUXOR475
	90	90	LUXOR490

Specchio spess. 5 mm ovale orizzontale o verticale molato.

Horizontal or vertical beveled oval mirror 5 mm thick.

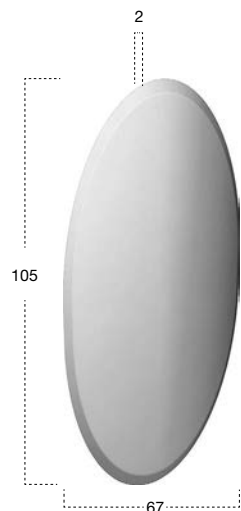

P	L	H	art.
2	67	105	LUXOR2

Specchio spess. 5 mm rettangolare orizzontale o verticale molato.

Horizontal or vertical beveled rectangular mirror 5 mm thick.

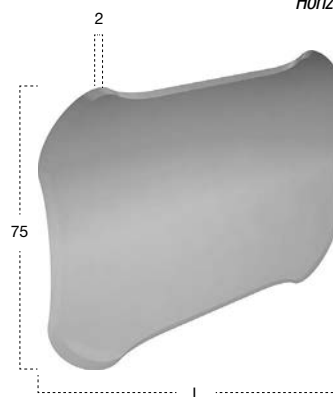

P	L	H	art.
2	117	75	LUXOR5117
	126	75	LUXOR5126

Specchio spess. 5 mm tondo molato.

Beveled round mirror 5 mm thick.

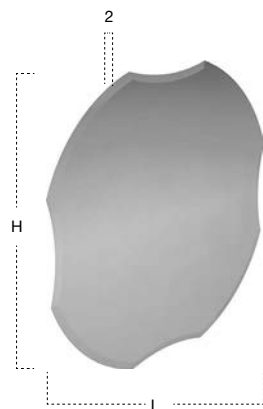

P	L	H	art.
2	75	75	LUXOR375
	90	90	LUXOR390

Specchio spess. 5 mm ovale orizzontale o verticale molato.

Horizontal or vertical beveled oval mirror 5 mm thick.

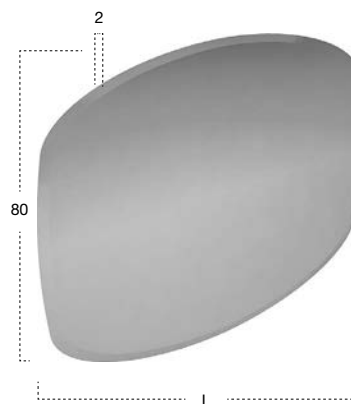

P	L	H	art.
2	117	80	LUXOR6117
	126	80	LUXOR6126

Specchio spess. 5 mm tondo molato con cornice in cristallo colorato argentato disponibile nei diversi colori: fumé, bronzo, rosé, blu, acquamarina.

Round beveled mirror 5 mm thick with a coloured and silvered glass frame available in various colours: fumé, bronze, rosé, blu and acquamarina.

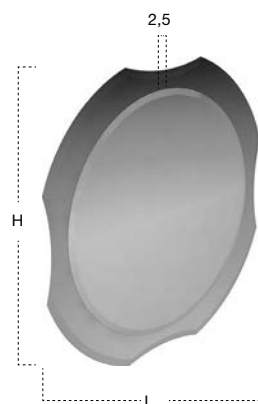

Specchio spess. 5 mm rettangolare orizzontale o verticale molato con cornice in cristallo colorato argentato disponibile nei diversi colori: fumé, bronzo, rosé, blu, acquamarina.

Rectangular beveled mirror 5 mm thick horizontal or vertical, with a coloured and silvered glass frame available in various colours: fumé, bronze, rosé, blu and acquamarina.

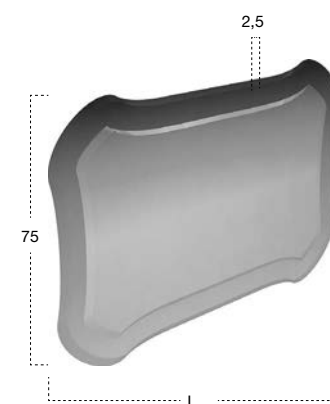

P	L	H	art.
2,5	75	75	LUXOR775
	90	90	LUXOR790

P	L	H	art.
2,5	117	75	LUXOR9117
	126	75	LUXOR9126

Specchio spess. 5 mm quadrato con cornice in cristallo colorato argentato disponibile nei diversi colori: fumé, bronzo, rosé, blu e acquamarina.

Round beveled mirror 5 mm thick with a coloured and silvered glass frame available in various colours: fumé, bronze, rosé, blu and acquamarina.

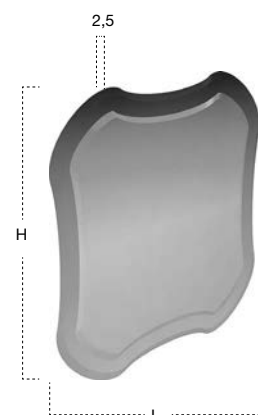

Specchio spess. 5 mm ovale orizzontale o verticale, molato con cornice in cristallo colorato argentato disponibile nei diversi colori: fumé, bronzo, rosé, blu e acquamarina.

Oval beveled mirror 5 mm thick horizontal or vertical, with a coloured and silvered glass frame available in various colours: fumé, bronze, rosé, blu and acquamarina.

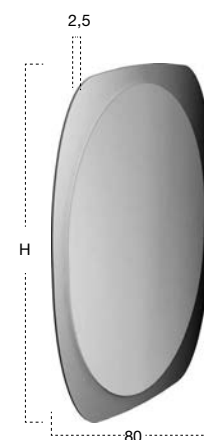

P	L	H	art.
2,5	75	75	LUXOR875
	90	90	LUXOR890

P	L	H	art.
2,5	117	80	LUXOR10117
	126	80	LUXOR10126

RONDÒ design Roberto Lazzeroni

Lampada da parete a led in vetro bronzo soffiato con supporti in ottone cromo lucido completa di 2 lampade.

LED wall lamp with blown bronze glass and polished brass supports complete with 2 bulbs.





Art. FORMA85

Art. FORMA54

Art. FORMA154

P	Ø	art.	
8,5	85	FORMA85	
P	L	H	art.
8,5	54	85	FORMA54
	54	185	FORMA154

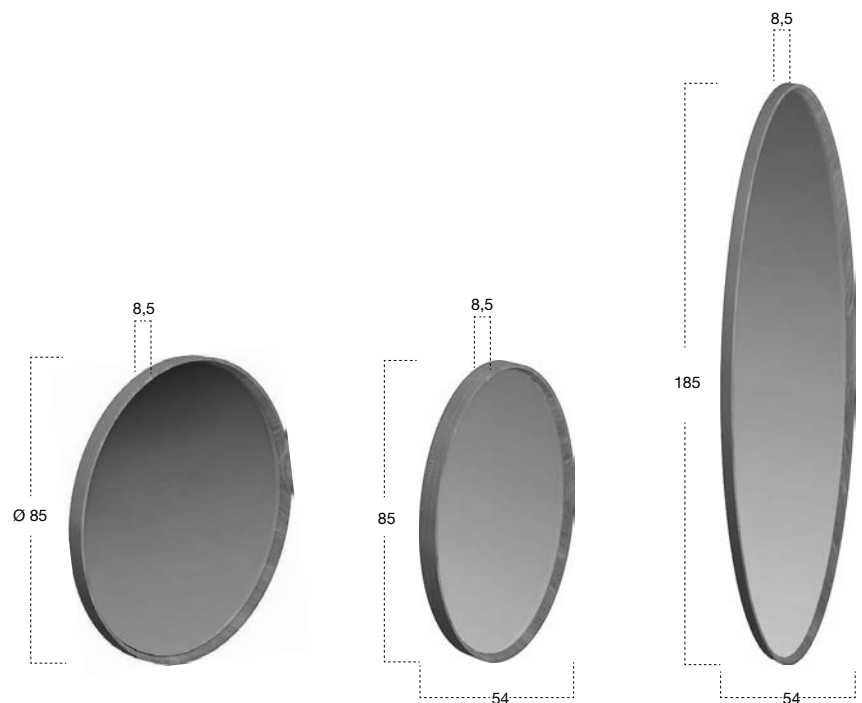

Specchio spess. 5 mm molato con cornice in massello di legno.

Round beveled mirror 5 mm thick with solid wood frame.