

# SEL ECT ION

MADE IN ITALY SINCE 1966





 NOVELLINI

# BEAUTY IS SIMPLICITY



Ogni nostro prodotto è progettato e realizzato per soddisfare le più recenti normative europee nel rispetto dell'ambiente. I processi produttivi a basso impatto ambientale, il controllo dell'immissione di sostanze tossiche e il considerevole risparmio energetico, sono le risposte alle problematiche di un mondo in costante evoluzione.

*All our products are designed and produced to meet the latest European regulations regarding respect for the environment. The low environmental impact production processes, checks on the release of harmful substances and significant energy savings are the response to the problems of a world that is constantly evolving.*

Chacun de nos produits est conçu et réalisé pour satisfaire dernières normes européennes en matière de respect de l'environnement. Les processus de production à faible impact environnemental, le contrôle de l'émission de substances toxiques et l'importante économie d'énergie sont les solutions aux aux problématiques du monde en constante évolution.

*Al onze producten zijn ontworpen en vervaardigd volgens de hoogste Europese normen op het gebied van kwaliteit, veiligheid en respect voor het milieu. Milieuvriendelijke productieprocessen, controles op het vrijkomen van schadelijke stoffen en aanzienlijke energiebesparingen zijn ons antwoord op de uitdagingen van de 21e eeuw.*

*Alle von uns entwickelten und hergestellten Produkte werden entsprechend den aktuellsten europäischen Verordnungen gefertigt und tragen damit zum Schutz der Umwelt bei. Produktionsprozesse mit geringen Auswirkungen auf die Umwelt, Kontrolle der Emission giftiger Substanzen und erhebliche Energieersparnisse sind die Antwort auf die Probleme einer sich ständig weiterentwickelnden Welt.*





## 01

**BOX DOCCIA**  
**SHOWER ENCLOSURE**  
**PAROIS DE DOUCHE**  
**DOUCHEWANDEN**  
**DUSCHABTRENNUNGEN**

06 GALA  
08 BRERA  
10 LOUVRE  
12 YOUNG  
14 YOUNG PLUS  
16 OPERA  
18 KUADRA 2.0  
20 ROSE  
22 ZEPHYROS  
24 LUNES 2.0

## 02

**SPAZI DOCCIA**  
**SHOWER SPACES**  
**ESPACES DE DOUCHE**  
**INLOOPDOUCHES**  
**WALK-IN LÖSUNGEN**

28 KUADRA H  
30 FRAME  
COLLECTION  
38 EDGE  
COLLECTION  
44 GALA H  
LUNES H  
SMART H

## 03

**SOPRAVASCA**  
**BATH SCREEN**  
**PARE - BAIGNOIRES**  
**BADWANDEN**  
**BADEWANNENAUFsätze**

46 GALA  
KUADRA  
YOUNG  
ROSE



## 04

**COLONNE**  
**EQUIPPED PANELS**  
**COLONNES DE DOUCHE**  
**DOUCHEPANELEN**  
**DUSCHPANEELE**

48 SINT  
LINE  
VANITY  
DRESS  
FLOW  
EASY

## 05

**ACCESSORI**  
**ACCESSORIES**  
**ACCESSOIRES**  
**ACCESSOIRES**  
**ZUBEHÖR**

36 ACCESSORIES  
FRAME  
42 ACCESSORIES  
EDGE  
50 ACCESSORIES

## 06

**PIATTI DOCCIA**  
**SHOWER TRAYS**  
**RECEVEURS DE DOUCHE**  
**DOUCHEBAKKEN**  
**DUSCHWANNEN**

54 NOVOSOLID  
56 CUSTOM  
57 CUSTOM TOUCH  
58 OLYMPIC  
VICTORY

## 07

**CABINE DOCCIA**  
**SHOWER CUBICLES**  
**CABINES DE DOUCHE**  
**COMPLETE (STOOM-)CABINES**  
**MULTIFUNKTIONSKABINEN**

62 SKILL  
64 GLAX 2.0  
66 EON  
92 REVOLUTION

## 08

**VASCHE**  
**BATHTUBS**  
**BAIGNOIRES**  
**BADEN**  
**BADEWANNEN**

70 INFINITIVE  
72 SHIP  
74 DIVINA DUAL  
76 DIVINA  
78 SENSE DUAL  
80 SENSE 3-4  
82 CALOS 2.0  
84 IRIS

## 09

**SPA IDROMASSAGGIO**  
**WHIRLPOOL BATHS**  
**BAIGNOIRES SPA**  
**SPA BADEN**  
**WHIRLPOOL BAD**

88 DIVINA OUTDOOR

## 10

**IN ART**

94 KUADRA H  
95 SOLE

La sintesi di comodità e stile in un oggetto di design perfezionato dalle innovazioni delle ultime tecnologie, che lo rendono un prodotto estremamente stabile e sicuro, oltre che altamente personalizzabile.  
Quando si sceglie un box Novellini si vuole uno spazio bagno facile da allestire e da mantenere.

*The synthesis of comfort and style in a design object perfected by the innovations of the latest technologies, which make it an extremely stable and safe product, as well as highly customizable.  
When choosing a Novellini box you want a bathroom space easy to set up and maintain.*

La synthèse parfaite du confort et du style en un objet design perfectionné par les innovations issues des dernières technologies qui en font un produit extrêmement stable, sûr et hautement personnalisable.  
En choisissant les parois de douche Novellini vous optez pour une salle de bains facile à aménager et à entretenir.

*Een samensmelting van comfort en stijl in een modern design, waarbij gebruik is gemaakt van de meeste innovatieve technieken die de douchewanden tot een solide en veilig product maken. De douchewanden van Novellini zijn naar eigen wensen samen te stellen eenvoudig te onderhouden.*

*Eine Synthese aus Zweckdienlichkeit und Stil. Dank Anwendung neuester Technologien sowie Beachtung von Innovationen ist auch Robustheit einer der Pluspunkte unserer Duschabtrennungen. Darüber hinaus stellen diese auch einen einzigartigen Designgegenstand dar und lassen sich ganz individuell gestalten.  
Wer sich für eine Duschabtrennung von Novellini entscheidet, entscheidet sich auch für ein pflegeleichtes Produkt.*



# 01

## **BOX DOCCIA SHOWER ENCLOSURE PAROIS DE DOUCHE DOUCHEWANDEN DUSCHABTRENNUNGEN**

- 06 GALA
- 08 BRERA
- 10 LOUVRE
- 12 YOUNG
- 14 YOUNG PLUS
- 16 OPERA
- 18 KUADRA 2.0
- 20 ROSE ROSSE
- 22 ZEPHYROS
- 24 LUNES 2.0



# GALA

MODERNO E FUNZIONALE  
DALLE LINEE RIGOROSE ED ESSENZIALI:  
LA QUALITÀ SENZA COMPROMESSI.

*MODERN AND FUNCTIONAL LINES,  
RIGOROUS AND ESSENTIAL:  
THE UNCOMPROMISING QUALITY.*

MODERNE ET FONCTIONNELLE.  
LIGNES STRICTES ET ESSENTIELLES :  
LA QUALITÉ SANS COMPROMIS.

*MODERN DESIGN,  
COMPLETE TRANSPARANTIE:  
KWALITEIT ZONDER COMPROMIS.*

MODERN UND FUNKTIONELL,  
REDUZIERT AUF DAS WESENTLICHE  
OHNE KOMPROMISSE.



Cerniere regolabili in metallo cromato  
*Adjustable hinges in chrome plated metal*  
Charnières réglables en métal chromé  
*Verstelbare scharnieren van verchromd metaal*  
Einstellbare Metallscharniere verchromt



Maniglia in metallo cromato  
*Chromed metal handle*  
Poignée en métal chromé  
*Greep van verchromd metaal*  
Metallhandgriff verchromt





GALA 2P+F



GALA 1B



GALA G+F



# BRERA

SEMPLICITÀ E PULIZIA  
DELLE LINEE PER VALORIZZARE  
AMBIENTI DALL'ARCHITETTURA  
ESSENZIALE E CONTEMPORANEA.

*SIMPLE, CLEAN LINES TO ENHANCE  
BATHROOMS WITH UNDERSTATED,  
CONTEMPORARY ARCHITECTURE.*

SIMPLICITÉ ET ÉLÉGANCE  
DES LIGNES POUR LES SALLES  
DE BAINS CONTEMPORAINES.

*EENVOUDIGE EN STRAKKE LIJNEN  
VOOR DE MODERNE BADKAMER.*

EINFACHE UND KLARE LI NIEN  
DIE IHRE RÄUMLICHKEITEN  
AUFWERTEN MIT ESSENTIELLER UND  
ZEITGENÖSSISCHER ARCHITEKTUR.



Cerniere regolabili in metallo cromato  
*Adjustable hinges in chrome plated metal*  
Charnières réglables en métal chromé  
*Verstelbare scharnieren van verchromd metaal*  
Einstellbare Metallscharniere verchromt



Maniglia in metallo cromato  
*Chromed metal handle*  
Poignée en métal chromé  
*Greep van verchromd metaal*  
Metallhandgriff verchromt





# LOUVRE

ELEGANTE E IMPORTANTE,  
SENZA RINUNCIARE ALLA STABILITÀ.

*ELEGANT AND GRAND,  
WITHOUT COMPROMISING STABILITY.*

ÉLÉGANCE ET ESPACE  
SANS RENONCER À LA STABILITÉ.

*ELEGANT EN RUIMTELIJK,  
ZONDER IN TE BOETEN OP STABILITEIT.*

ELEGANT UND BEDEUTEND,  
OHNE AUF STABILITÄT ZU VERZICHTEN.



Cerniere in metallo cromato con sollevamento dell'anta  
*Chrome-plated metal hinges with door lift device*  
Charnières chromées avec système de relevage  
*Scharnieren mit liftsystem*  
Metallscharniere mit Hebe-Senk-Mechanik



Profilo di tenuta a pavimento  
*Bottom sealing profile*  
Barre de sol pour un accès facile  
*Waterkeringset*  
Dichtungsprofile für den Boden



LOUVRE G



LOUVRE A



LOUVRE R



# YOUNG

DESIGN MINIMALE E LINEARE  
PER L'ACCESSO AL COMFORT COMPLETO.

*MINIMAL, LINEAR DESIGN  
FOR ACCESSING TOTAL COMFORT.*

DESIGN EXCLUSIF ET MINIMALISTE  
POUR ACCÉDER AU CONFORT TOTAL.

*MINIMALISTISCH EN LINEAIR DESIGN  
VOOR COMPLEET COMFORT.*

WENIGER PROFIL UND MEHR GLAS  
EINE KLARE, SAUBERE UND  
PFLEGELEICHTE ÄSTHETIK.



Possibilità di apertura interno/esterno  
*In/Out opening door*  
Ouverture intérieure / extérieure  
*Opening naar binnen en buiten*  
In-Out Öffnung



Cerniere con sollevamento dell'anta  
*Chrome plated rise and fall metal hinges*  
Charnières métal avec système de relevage  
*Scharnieren met liftstysteem*  
Metallscharniere mit Hebe-Senk Mechanismus



YOUNG G+F IN LINEA / IN LINE



YOUNG G+F



YOUNG 2GS



# YOUNG PLUS

LO SPESSORE DELL’AFFIDABILITÀ.

*THE PURITY OF DESIGN AND RELIABILITY.*

LA FIABILITÉ ESSENTIELLE.

*DE KRACHT VAN BETROUWBAARHEID.*

DIE „STÄRKE“ DER ZUVERLÄSSIGKEIT.

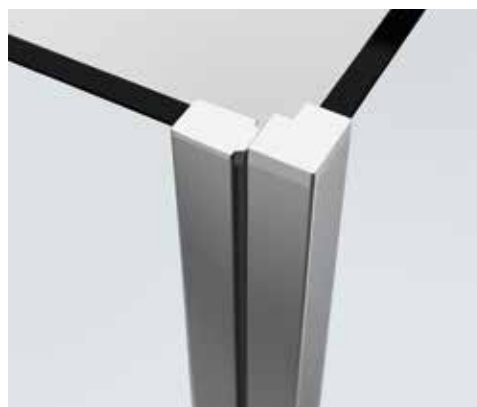

Profili magneti  
*Double magnet profiles*  
Profilé magnétique  
*Magneet in profiel*  
Alu Magnetprofile



Spessore vetro 8 mm  
*Glass thickness 8 mm*  
Verre épaisseur 8 mm  
*Glasdike 8 mm*  
Glasstärke 8 mm





YOUNG PLUS G+F



YOUNG PLUS G+F IN LINEA / IN LINE



YOUNG PLUS 1B



# OPERA

TRASPARENZA, SILENZIOSITÀ E SICUREZZA,  
UNA STRUTTURA DI GRANDE  
SCORREVOLEZZA E AFFIDABILITÀ.

*TRANSPARENT, SILENT AND SAFE  
A HIGHLY RELIABLE FRAMED DOOR.*

TRANSPARENCE, SILENCE ET SÉCURITÉ :  
GLISSEMENT FLUIDE ET HAUTE FIABILITÉ.

*TRANSPARANT, GERUISLOOS EN VEILIG:  
VLOEIENDE BEWEGINGEN BIJ OPENEN  
EN SLUITEN.*

TRANSPARENT, LEISE UND SICHER.  
PROFILE GEBEN VERTRAUEN.



Sistema Soft Closing in apertura e chiusura  
*Soft Opening and Closing System*  
Système d'ouverture et de fermeture Soft Close  
*Soft-Close systeem voor openen en sluiten*  
Türen mit Bremsmechanik beim Öffnen und Schließen

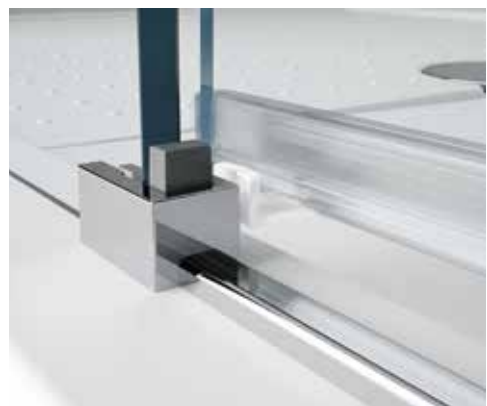

Sistema di sgancio ante scorrevoli  
*Releasable door system*  
Système Click & Clean  
*Click & Clean systeem*  
Alu-Schwallschutzleiste + Aushängemechanismus



OPERA PH+FH



OPERA 2PH



OPERA A



# KUADRA 2.0

MINIMALISMO GEOMETRICO  
E SENSAZIONI DI BENESSERE.

*ROBUST GEOMETRIC MINIMALISM  
AND WELLNESS FEELING.*

MINIMALISME GÉOMÉTRIQUE  
ET SENSATION DE BIEN-ÊTRE.

*GEOMETRISCH MINIMALISME  
VOOR EEN GEVOEL VAN WELZIJN.*

GEOMETRISCHER MINIMALISMUS  
FÜR EIN GEFÜHL DES WOHLBEFINDENS.



Carrello di scorrimento con cuscinetti a sfera  
*Sliding system with double carriage*  
Système de roulettes avec roulements à billes  
*Schuifstelsel met kogellagers*  
Hochwertige Rolltechnik mit Kugellager



Soft closing  
*Soft closing*  
Soft Close : fermeture amortie  
*Soft close*  
Soft closing



KUADRA 2.0 PH+FH



KUADRA 2.0 AH



KUADRA 2.0 G



# ROSE

SOLUZIONI PER AMPI SPAZI  
E GRANDE VERSATILITÀ.

*ULTRA-VERSATILE SOLUTIONS  
FOR LARGE SPACES.*

COLLECTION ESTHÉTIQUE.  
GRANDES LARGEURS ET MODULARITÉ.

*OPLOSSINGEN VOOR GROTE  
RUIMTES EN VEEL SITUATIES.*

MODERNES DESIGN UND  
GROSSE MODELLVIELFALT.

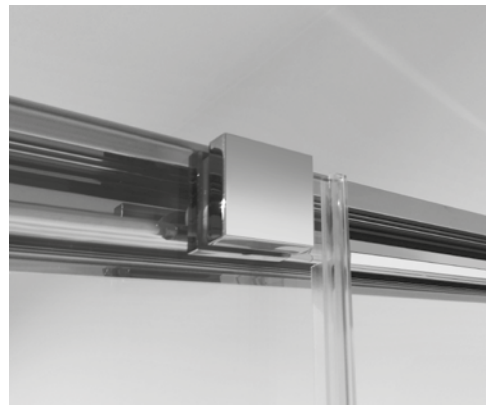

Tecnica e funzionalità.  
*Technology and functionality*  
Technique et fonctionnelle  
*Betrouwbare techniek*  
Zuverlässige Technik



ROSE EVO - Sistema di sgancio ante scorrevoli  
*ROSE EVO - Releasable door system*  
ROSE EVO - Panneau coulissant déclipable  
*ROSE EVO - Click & Clean systeem*  
ROSE EVO - Alu-Schwallschutzleiste + Aushängemechanismus





# ZEPHYROS

LA PIÙ AMPIA GAMMA  
DI FINITURE E COMBINAZIONI.

*THE WIDEST RANGE OF FINISHES  
AND COMBINATIONS.*

LARGE CHOIX DE FINITIONS DE PROFILÉS  
ET DE VITRAGES.

*EEN GROOT AANBOD AAN GLAS- EN  
PROFIELAFWERKINGEN.*

DAS UMFANGREICHSTE ANGEBOT  
AN PROFIL- UND GLASVARIANTEN.  
FINDEN SIE DIE PASSENDE LÖSUNG  
FÜR IHR BADEZIMMER.



Maniglia in metallo  
Metal handle  
Poignée en métal  
Metalen handgreep  
Metallhandgriff



Ampia scelta di finiture per personalizzare il bagno  
*Choice of colours to give character to your bathroom*  
Choix de finitions pour personnaliser votre salle de bains  
*Een rijk palet aan kleuren*  
Große Auswahl an Ausführungen zur Personalisierung  
Ihres Badezimmers





ZEPHYROS 2P



ZEPHYROS G



ZEPHYROS A



# LUNES 2.0

IMMAGINA QUANTE  
PIÙ COMBINAZIONI PUOI,  
AGGIUNGINE ANCORA.

*THE WIDEST COMBINATIONS  
YOU CAN IMAGINE.*

UNE MULTITUDE DE CONFIGURATIONS,  
BIEN PLUS QUE CE QUE VOUS POUVEZ  
IMAGINER.

*DE RUIMSTE KEUS DIE JE KAN  
BEDENKEN EN DAN NOG MEER.*

STELLEN SIE SICH SO VIELE  
KOMBINATIONEN VOR WIE MÖGLICH.  
UND FÜGEN SIE NOCH MEHR HINZU.



Maniglia  
Handle  
Poignée  
Handgriep  
Handgriff



Sistema di sgancio anta per una facile pulizia  
*Releasable door for easy clean*  
Système Click & Clean (option)  
*Click & Clean systeem (optioneel)*  
Optionale Rollen mit Aushängemechanismus



LUNES 2.0 2P+F



LUNES 2.0 A



LUNES 2.0 3P

Lo spazio doccia di Novellini fa rima con design e stile. Uno dei plus di questo oggetto d'arredo, è la possibilità di configurarlo a seconda delle proprie esigenze, combinando insieme i differenti elementi che lo compongono.

*The Novellini shower space rhymes with design and style. One of the plus features of this furnishing item is the possibility of configuring it to suit individual requirements, by combining the different elements that make it up.*

Les parois de douche walk-in Novellini incarnent design et style. L'un de leurs principaux avantages est la possibilité de combiner les différents éléments pour créer un espace de douche personnalisé.

*Novellini inloopdouches staan voor design en stijl. Met deze douchewanden is eenvoudig elke gewenste combinatie in de badkamer te creëren.*

Novellini Duschplatz, sprich Design und Stil. Einer der Pluspunkte dieses Einrichtungsgegenstandes ist die individuelle Gestaltbarkeit, indem man die verschiedenen Elemente miteinander kombiniert.



# 02

**SPAZI DOCCIA  
SHOWER SPACES  
ESPACES DE DOUCHE  
INLOOPDOUCHES  
WALK-IN LÖSUNGEN**

- 28 KUADRA H
- 30 FRAME COLLECTION
- 38 EDGE COLLECTION
- 44 GALA H  
LUNES H  
SMART H



# KUADRA H

IL NOSTRO SPAZIO DI BENESSERE  
QUOTIDIANO INISIA MOLTO PRIMA  
DEL CONTATTO CON L'ACQUA.

*OUR DAILY WELLNESS BEGINS  
BEFORE OUR CONTACT WITH WATER.*

NOTRE BIEN-ÊTRE QUOTIDIEN  
COMMENCE BIEN AVANT  
LE CONTACT AVEC DE L'EAU.

*ONS DAGELIJKS WELZIJN  
BEGINT NOG VOOR HET EERSTE  
CONTACT MET WATER.*

DER KONTAKT MIT WASSER  
FÜHRT SIE IN MOMENTE  
DES TÄGLICHEN WOHLBEFINDENS.



Barra a soffitto  
*Profile of fixing ceiling glass*  
Barre de fixation au plafond  
*Profiel voor plafondbevestiging*  
Deckenstütze



Nuovo sistema EVO e nuovi moduli per estetica e funzionalità  
*New Evo system and new modules for aesthetics and functionality*  
Système de fixation EVO esthétique et fonctionnel  
*Bevestigingssysteem "EVO": esthetisch en functioneel*  
Neue ästhetische und funktionelle Optinen



KUADRA H+H STRIPES



KUADRA H+HFA



KUADRA H



# F



# A



# M



# R

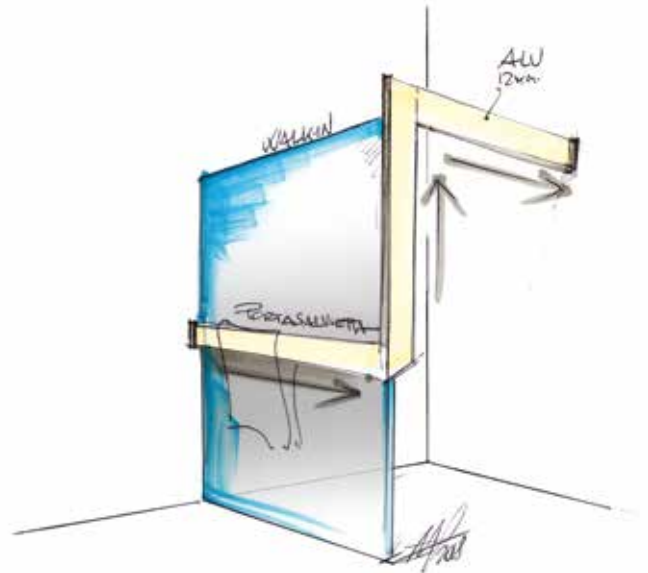

# E





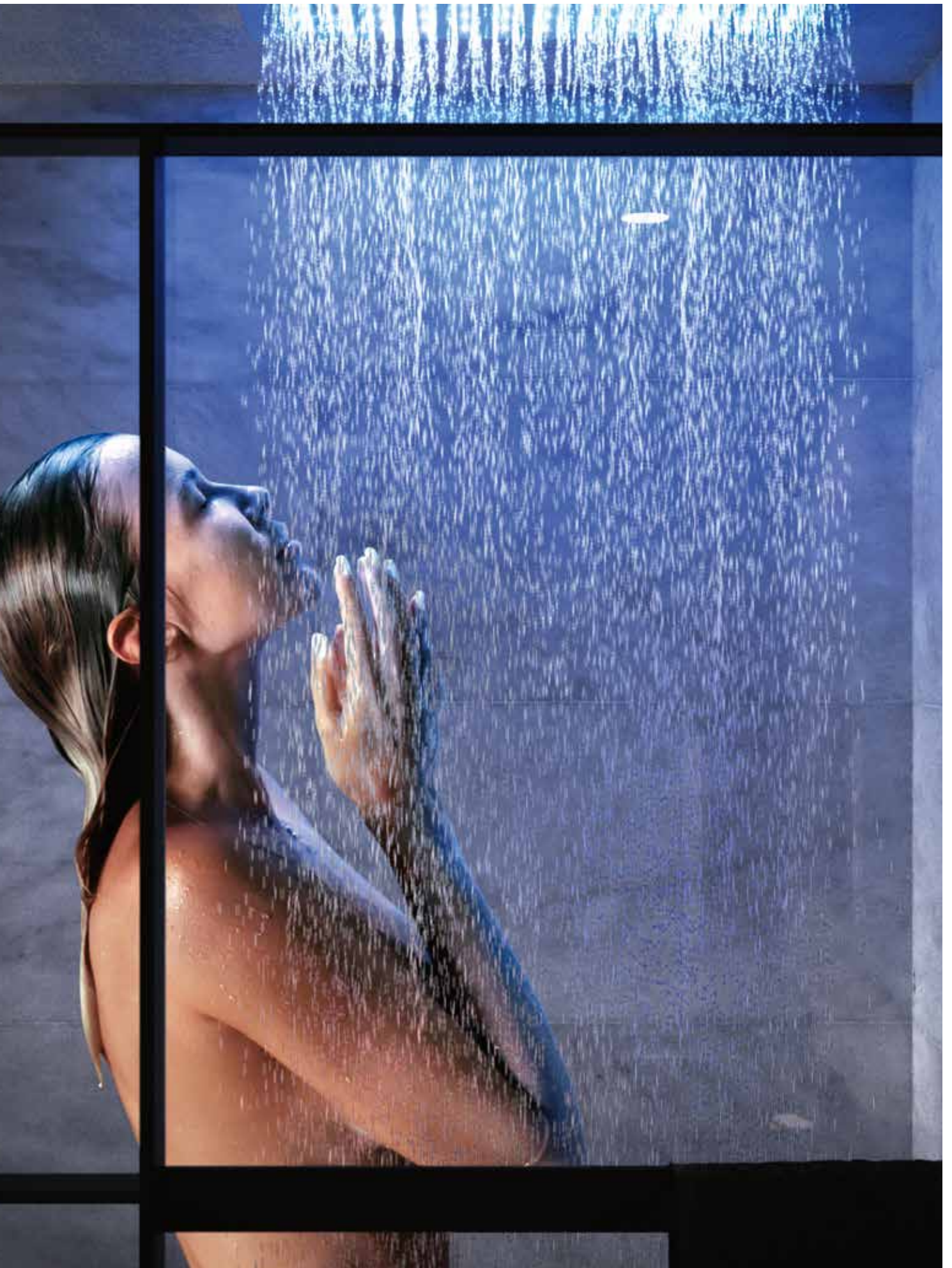



# FRAME COLLECTION KUADRA H



KUADRA H KIT FRAME



Porta oggetti interno  
*Internal shelf*  
Etagère porte-objets à l'intérieur  
*Planchet aan binnenkant*  
Ablage innen



Porta salviette esterno  
*External towel holder*  
Porte-serviette à l'extérieur  
*Handdoekhouder aan buitenkant*  
Handtuchhalter außen



KUADRA H+H FRAME



KUADRA HF KIT FRAME



KUADRA HW FRAME

# FRAME COLLECTION KUADRA H

ACCESSORI

ACCESSORIES

ACCESSOIRES

ACCESSOIRES

ACCESSOIRES

- ❶ *due mensole interne + porta tergovetro + gancio al vetro*  
*two internal shelves + wiper holder and external towel hook to attach to glass*  
*deux étagères internes + porte-raclette + crochet porte-serviette*  
*twee plankets + wisserhouder + externe haak op glaswand*  
*Zwei Ablagen auf der Innenseite + Halterung für den Duschabzieher und einen Handtuchhaken zur Glasbefestigung*
- ❷ *mensola interna e porta salviette esterno da agganciare a vetro*  
*internal shelf and external towel hook to attach to glass*  
*étagère interne et porte-serviette extérieur à poser sur la paroi*  
*planchet en externe handdoekhouder op glaswand*  
*Ablage auf der Inneseite und Handtuchhalter auf der Außenseite*
- ❸ *tre mensole interne e gancio porta salviette esterno da agganciare a vetro*  
*three internal shelves and external towel hook to attach to glass*  
*trois étagères intérieures et crochet porte-serviette extérieur, à poser sur la paroi*  
*drie plankets en externe haak op glaswand*  
*Drei Ablagen auf der Innenseite und ein Handtuchhalter auf der Außenseite*
- ❹ *colonna porta salviette, portarotolo e porta scopino*  
*floor-standing towel holder, toilet roll holder and brush holder*  
*porte-rouleau simple + porte porte-balai*  
*handdoekhouder, toiletrolhouder + toiletborstel*  
*Bürstengarnitur, Handtuchhalter und WC-Papierhalter bodenstehend*
- ❺ *mensola*  
*shelf*  
*étagère*  
*planchet*  
*ablage*
- ❻ *perno appendiabiti a muro doppio*  
*double wall clothes hook*  
*crochet double*  
*dubbele haak*  
*Handtuchakter mit 2 Haken*
- ❼ *mensola con porta-bicchiere + porta dosatore per sapone*  
*shelf with glass + soap dispenser*  
*étagère avec emplacement pour verre et distributeur de savon*  
*planchet met ruimte voor glas en zeepdispenser*  
*Becherhalter und Seifenspender*
- ❽ *mensola dogata porta asciugamani*  
*slatted shelf towel rack*  
*étagère porte-serviette*  
*handdoekrek*  
*Handtuchablage*



# E



# D

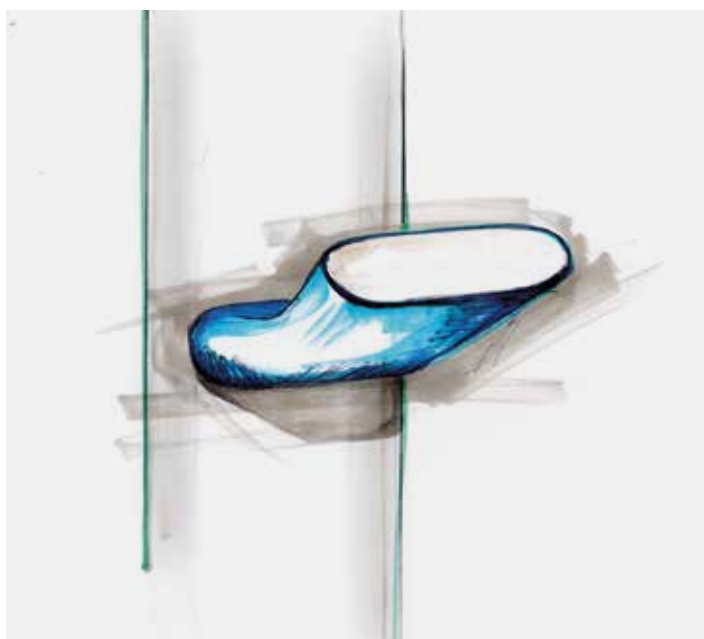



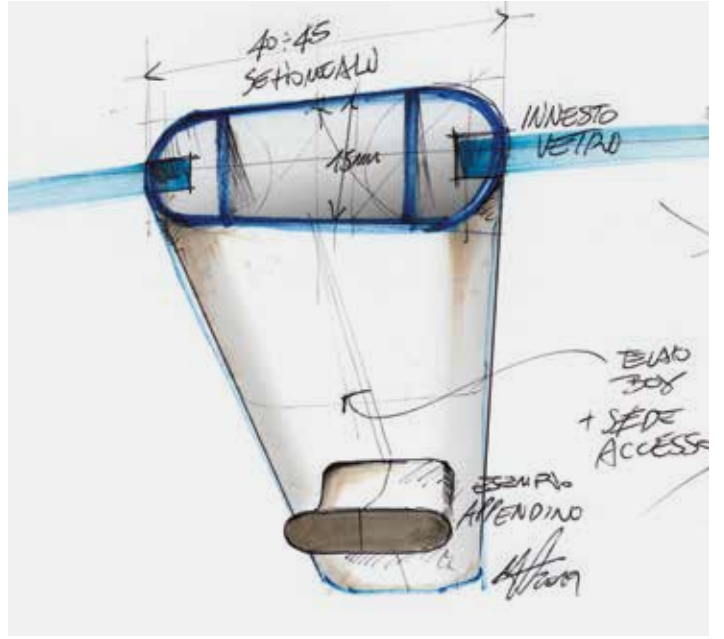

**G**



**E**



# EDGE COLLECTION GIADA H



Barra esterna portasalviette  
*External towel holder*  
Porte-serviette  
*Handdoekhouder*  
Handtuchhalter auf der Außenseite



Barra speciale fino a terra  
*Special full length bar*  
Barre de renfort spéciale jusqu'au sol  
*Speciale muursteun tot vloer*  
Spezial Stabilisationsstange



GIADA H EDGE



GIADA H+HP EDGE



GIADA H+H EDGE

# EDGE COLLECTION GIADA H

ACCESSORI

ACCESSORIES

ACCESSOIRES

ACCESSOIRES

ZUBEHÖR

- ❶ perno appendiabiti fissato a muro  
*clothes hook*  
crochet fixation au mur  
*haak voor muur*  
Kleiderhaken
- ❷ bicchiere fissato a muro  
*double towel rail*  
porte-gobelet fixation au mur  
*bekerhouder voor muur*  
Becherhalter
- ❸ dosasapone fissato su profilo  
*soap dispenser*  
porte distributeur de savon fixation au profilé  
*zeepdispenser voor profiel*  
Seifenspender
- ❹ porta-tergivetro fissato a muro  
*wiper holder*  
porte-raclette fixation au mur  
*wisserhouder voor muur*  
Halterung für Duschabzieher
- ❺ mensola fissata al profilo  
*slatted shelf towel rack*  
étagère fixation au profilé  
*planchet voor profiel*  
Handtuchablage
- ❻ porta - rotolo  
*toilet roll holder*  
porte - rouleau  
*toiletrolhouder*  
Rollenhalter
- ❼ porta scopino  
*toilet brush holder*  
porte - balai  
*toiletborstelhouder*  
WC-Bürstenhalter
- ❽ portarotolo e porta scopino  
*toilet roll and brush holder*  
porte-rouleau et porte porte-balai  
*toiletrolhouder + toiletborstel*  
WC Garnitur+ Rollenhalter





GALA H



LUNES H



SMART H

# GALA H

# LUNES H

# SMART H



GALA H



LUNES H



SMART H



# 03

## **SOPRAVASCA BATH SCREENS PARE-BAIGNOIRES BADWANDEN BADEWANNENAUFsätze**

Box doccia e vasca in un'unica soluzione: con il sopravasca di Novellini, convenienza fa rima con praticità.

*Shower cubicle and bath all in one: thanks to the Novellini bath screen, value for money rhymes with practicality.*

Douche et bain en une seule solution : avec les pare-baignoires Novellini, le bien-être rime avec praticité.

*Douche en bad in één; Novellini badwanden zijn praktisch en kenmerken zich door een goede prijs/kwaliteit verhouding.*

Duschabtrennung und Wanne in einer einzigen Lösung: Beim Novellini Wannenaufsatz geht Vorteilhaftigkeit mit Zweckmäßigkeit einher.





YOUNG 1BSV



ROSE PHV+F



KUADRA 3V



YOUNG 1V



# 04

## **COLONNE EQUIPPED PANELS COLONNES DE DOUCHE DOUCHEPANELEN DUSCHPANELEE**

Le colonne attrezzate ti permettono di abbondare con i dettagli e concederti un'esperienza doccia da sogno grazie all'idromassaggio incorporato. Scegliere le colonne doccia di Novellini significa, infatti, mettere la tecnologia al servizio del tuo bagno.

*The shower columns enable you to abound with details and give yourself a dream shower experience thanks to the integrated whirlpool. Choosing the Novellini shower columns does in fact mean placing technology at the service of your bathroom.*

Les colonnes de douche Novellini vous donnent la possibilité de choisir les finitions et les matières pour donner du caractère à votre espace douche. Grâce aux jets hydromassants, vous pourrez vivre des moments de pure bien-être et profiter pleinement de la praticité et des avantages de la technologie.

*Novellini douchepanelen: een rijk scala aan materiaalgebruik en kleuren. De ingebouwde hydromassage jets bieden een onvergetelijke douche-ervaring. Een keuze voor een douchepaneel van Novellini is een keuze voor de nieuwste techniek in douchen.*

Die Duschpaneele ermöglichen eine Vielfalt von Details und Sie können sich dank der eingebauten Hydromassage ein traumhaftes Duscherlebnis gönnen. Durch Bevorzugung eines Novellini Duschpaneels holen Sie sich neueste Technologie in Ihr Bad.



VANITY S



LINE 2



DRESS PLUS



EASY 2



SINT



FLOW



# 05

## ACCESSORI ACCESSORIES ACCESSOIRES ACCESSOIRES ZUBEHÖR

Tra gli accessori Novellini potrai trovare i complementi giusti per la tua doccia, cabina o vasca da bagno.

*The Novellini range includes a wide selection of accessories for your shower, cabin or bathtub.*

La gamme Novellini comprend une vaste sélection d'accessoires pour votre douche, cabine ou baignoire.

*Het assortiment van Novellini omvat een breed aanbod aan accessoires voor douche, douchecabine of bad.*

Die Produktpalette von Novellini umfasst eine breite Auswahl an Zubehör für Ihre Dusche, Duschkabine oder Badewanne.

- 1 sgabello  
stool  
tabouret  
krukje  
Hocker
- 2 porta salviette da parete  
wall mounted towel rail  
porte-serviette mural  
handdoekhouder  
badetuchhalter (wandbefestigung)
- 3 cestino angolare a due feritoie  
corner basket 2 slits  
panier angulaire à deux lucarnes  
fles- en sponshouder hoek  
duschkorb zweifach
- 4 cestino doppio a due feritoie  
corner basket 2 slits  
panier double à deux lucarnes  
dubbele korf  
eckduschkorb
- 5 Serie FLY 3  
miscelatore monocomando alto per lavabo  
single lever mixer for washbasin high version  
mitigeur monocommande haut pour lavabo  
éénhendelmengkraan voor wastafel - hoge uitvoering  
waschtischarmatur
- 6 Serie FLY 3  
miscelatore monocomando basso per lavabo  
single lever mixer for washbasin low version  
mitigeur monocommande bas pour lavabo  
éénhendelmengkraan voor wastafel - lage uitvoering  
waschtischarmatur
- 7 Serie D  
miscelatore monocomando per lavabo  
single lever mixer for washbasin  
mitigeur monocommande pour lavabo  
éénhendelmengkraan voor wastafel - lage uitvoering  
waschtischarmatur

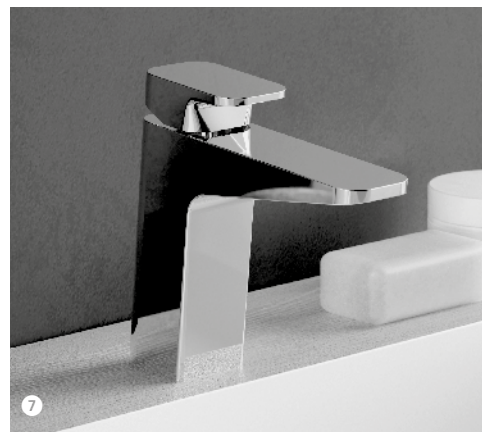
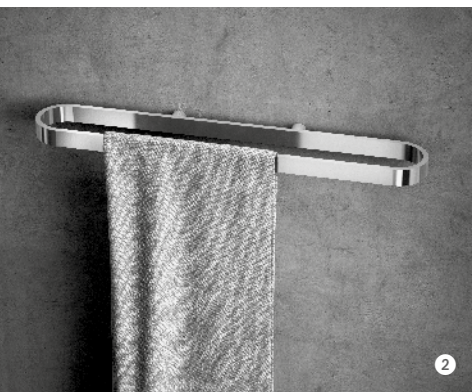

Incredibilmente resistente agli urti e di facile collocazione, il piatto doccia Novellini diventa la base stabile di un benessere quotidiano. Sempre essenziale ed elegante, il design si fa ancor più moderno nelle serie ultra piatte.

*Incredibly resistant to impact and easy to install, the Novellini shower tray becomes the stable base of a daily wellness. Always essential and elegant, design is even more crucial element in the ultra flat series.*

Résistants et faciles à installer, les receveurs de douche Novellini sont une base stable de votre bien-être quotidien. Leur design essentiel et harmonieux est encore plus moderne pour les modèles extraplats.

*De stootvaste en eenvoudig te installeren douchebakken van Novellini zijn de stabiele basis voor het dagelijks welzijn. Het minimalistische design en de elegantie komen het best tot zijn recht bij de ultravlakke modellen.*

Die unglaublich stoßfeste und praktisch einzubauende Duschwanne von Novellini wird zur Grundlage des täglichen Wohlbefindens. Stets essentielles und elegantes Design, dessen moderner Charakter bei den ultraflachen Modellen noch deutlicher zum Vorschein kommt.





# 06

**PIATTI DOCCIA  
SHOWER TRAYS  
RECEVEURS DE DOUCHE  
DOUCHEBAKKEN  
DUSCHWANNEN**

- 54 NOVOSOLID
- 56 CUSTOM
- 57 CUSTOM TOUCH
- 58 OLYMPIC  
VICTORY



# NOVOSOLID

UNA NUOVA FILOSOFIA DI PENSARE  
LO SPAZIO CHE VI CIRCONDA.  
NOVOSOLID CONSENTE DI ADATTARE  
IL PIATTO DOCCIA A VARIE SITUAZIONI.

*IT'S A NEW PHILOSOPHY OF THINKING  
THE BATHROOM SPACE.*

*NOVOSOLID ALLOWS US TO ADAPT  
THE SHOWER TRAY TO ANY SITUATION.*

UNE NOUVELLE PHILOSOPHIE DE PENSER  
L'ESPACE DE LA SALLE DE BAINS.  
CE RECEVEUR VOUS PERMET D'ADAPTER  
LA DOUCHE AUX DIVERSES SITUATIONS

*EEN NIEUWE FILOSOFIE VOOR  
HET VORMGEVEN VAN DE RUIMTE.  
DE DOUCHEBAKKEN NOVOSOLID KUNNEN  
AAN VERSCHILLENDE SITUATIES  
WORDEN AANGEPAST.*

IST EINE NEUE DENKWEISE DER  
RAUMGESTALTUNG, DIE ES ERMÖGLICHT,  
DIE DUSCHTASSE DEN VERSCHIEDENSTEN  
EINBAUSITUATIONEN ANZUPASSEN.

FINITURE / COLOURS / FINITIONS / AFWERKING / FARBEN



Texture naturale effetto pietra in bianco o nero  
*Natural stone texture effect in white or slate black*  
Texture effet pierre naturelle en blanc ou noir  
*Composiet: natuurlijk steeneffect in wit of zwart*  
Oberflächenbearbeitung Naturstein-Effekt in weiß oder schwarz

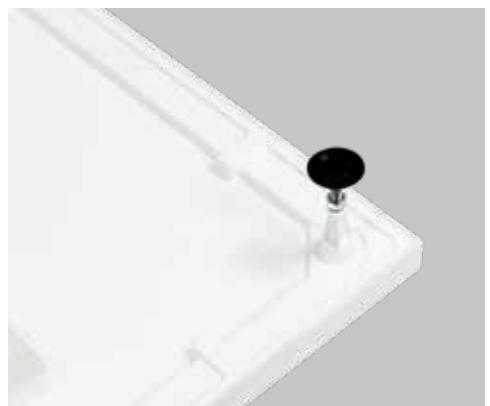

Stampaggio con nervatura per una maggiore garanzia di planarità  
*Moulding with ribs for an increases assurance of stability*  
Moulage avec nervures pour une stabilité optimale  
*Reliëf aan de onderkant voor optimale stabiliteit*  
Verstärkungsrippen für bessere Stabilität  
und Einsatz von einstellbaren Füßen







 Antigraffio, antimacchia, di facile pulizia  
*Scratch-proof, stain-proof, easy to maintain clean*  
 Anti-rayure, résistant aux taches, facile à nettoyer  
*Kleine krassen of vlekken zijn eenvoudig te verwijderen*  
 Kratzfest, schmutzabweisend, reinigungsfreundlich

 Massimo comfort tattile  
*Soft underfoot for maximum comfort*  
 Confort maximum au toucher  
*Maximaal aanraakcomfort*  
 Maximaler taktiler Komfort

 Effetto pietra grazie a materiali e finiture proposte  
*Stone effect thanks to the materials and finishes offered*  
 Effet de pierre grâce aux matériaux et aux finitions proposées  
*Luxe uitstraling dankzij de natuurlijke materialen en fraaie afwerking*  
 Steineffekt dank der angebotenen Materialien und Finishes

 Massima impermeabilità grazie al rivestimento totale in gelcoat  
*Maximum impermeability thanks to the total gelcoat*  
 Résistance maximum à l'eau grâce au revêtement total en gelcoat  
*Maximale waterbestendigheid dankzij de gelcoat afwerking*  
 Maximale Undurchlässigkeit dank der vollständigen Beschichtung mit Gelcoat



# CUSTOM

IL PIATTO DOCCIA STABILE E RESISTENTE AGLI URTI  
CHE RIESCE AD ESSERE ADATTO A TUTTE LE ESIGENZE DI SPAZIO.

*THE STABLE AND RESISTANT SHOWER TRAY  
THAT CAN BE ADAPTED TO ANY SPACE REQUIREMENTS.*

LE RECEVEUR DE DOUCHE EXTRAPLAT  
ADAPTÉ À TOUTES LES CONFIGURATIONS

*EEN STABIELE EN STOOTVASTE DOUCHEBAK  
DIE AAN ALLE SPECIALE SITUATIES KAN WORDEN AANGEPAST.*

DIE STABILE UND STOSSSICHERE BRAUSETASSE  
DIE JEDEM PLANUNGSBEDÜRFNIS GERECHT WIRD.

FINITURE / COLOURS / FINITIONS / AFWERKING / FARBEN



Piletta ispezionabile ad alta evacuazione  
*Drain with exhaust flow 40 litres / minute*  
Bonde débit 40 litres/minute  
*Inclusief sifon met grote afvoercapaciteit*  
Abfluß mit großem Durchflussvermögen und  
Edelstahlabdeckung



Barre di rinforzo in metallo  
*Reinforcing steel profiles*  
Profilé de renfort en acier  
*Stalen verstevigingsprofiel*  
Verstärkungsprofile aus Edelstahl



# CUSTOM TOUCH

IL NUOVO PIATTO DOCCIA CON TEXTURE NATURALE.

*THE NEW SHOWER TRAY WITH NATURAL TEXTURE.*

LE NOUVEAU RECEVEUR DE DOUCHE AVEC TEXTURE NATURELLE.

*EEN NIEUWE DOUCHEBAK MET NATUURLIJKE TEXTUUR.*

DIE NEUE DUSCHTASSE MIT EINER NATÜRLICHEN TEXTUR.

FINITURE / *COLOURS* / FINITIONS / *AFWERKING* / FARBEN

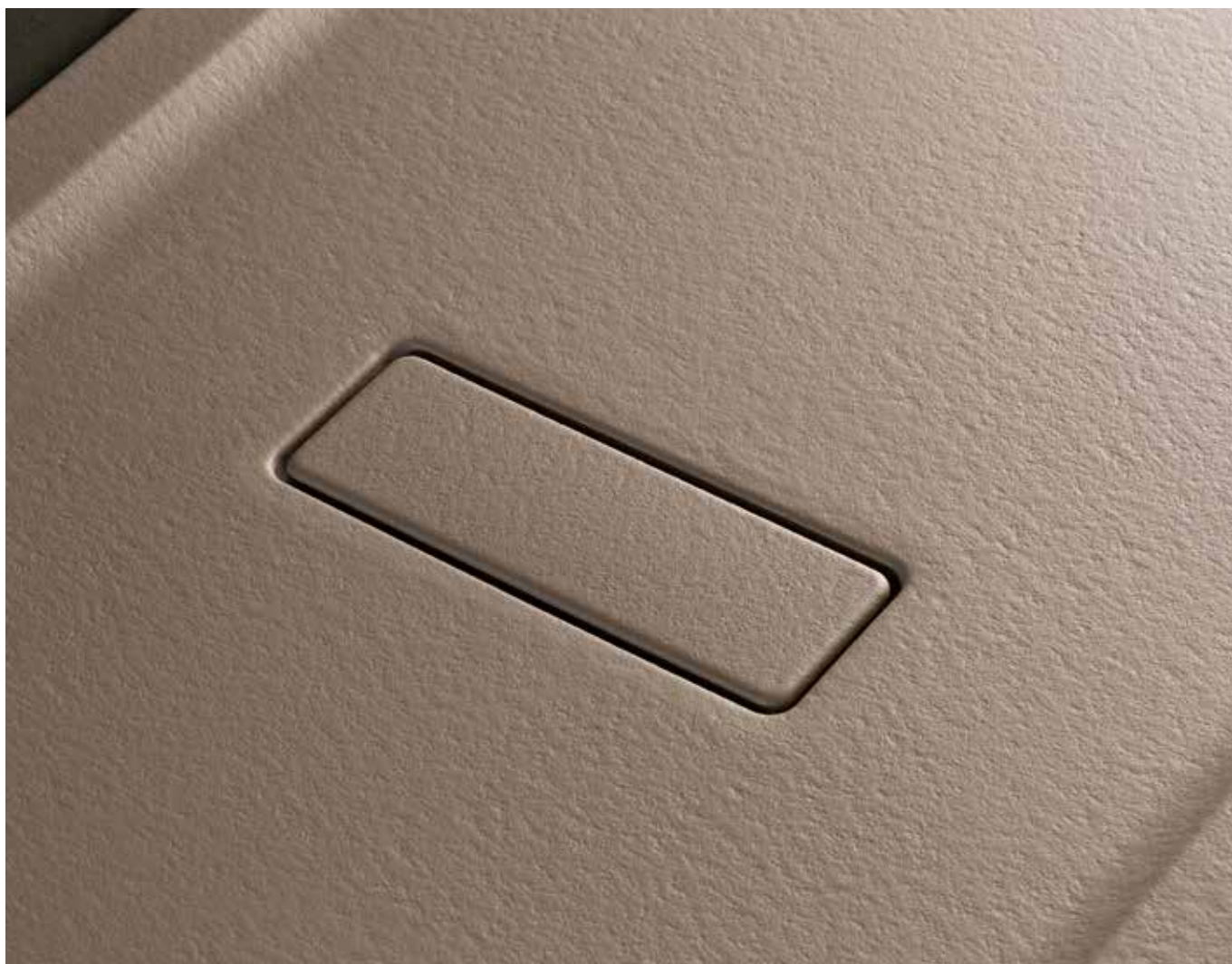
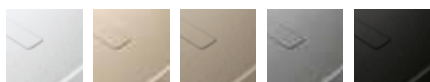



OLYMPIC



VICTORY

# OLYMPIC / VICTORY

ADATTABILI A TUTTE LE SITUAZIONI PROGETTUALI, I PIATTI DOCCIA NOVELLINI GARANTISCONO MASSIMA STABILITÀ GRAZIE ALL'ESTREMA RESISTENZA AGLI URTI.

*ABLE TO CATER TO ALL DESIGN REQUIREMENTS, THE NOVELLINI SHOWER TRAY ENSURES UTMOST STABILITY THANKS TO EXTREME RESISTANCE TO KNOCKS.*

ADAPTÉS À TOUTES LES CONFIGURATIONS, LES RECEVEURS DE DOUCHE NOVELLINI ASSURENT UNE STABILITÉ OPTIMALE GRÂCE À LEUR TRÈS GRANDE RÉSISTANCE AUX CHOCS.

*DANKZIJ DE VELE KLEUROPTIES PASSEN DE NOVELLINI DOUCHEBAKKEN ZICH AAN ELKE BADKAMERSTIJL AAN, BOVENDIEN BIEDEN ZE MAXIMALE STABILITEIT TIJDENS HET DOUCHEN.*

DIE NOVELLINI DUSCHWANNEN PASSEN SICH JEDER ENTWURFSSITUATION AN UND GEWÄHREN DANK DER AUSSERGEWÖHNLICHEN STOSSFESTIGKEIT MAXIMALE STABILITÄT.

FINITURE / COLOURS / FINITIONS / AFWERKING / FARBEN



OLYMPIC PLUS



OLYMPIC



VICTORY

Comode, funzionali e personalizzabili, queste affascinanti soluzioni di design accostano all'estetica ricercata l'aspetto multifunzionale e multisensoriale per soddisfare il desiderio di relax.

*Comfortable, functional and customizable, these fascinating design solutions match the multifunctional and multi-sensory elements to satisfy the desire to relax.*

Pratiques, fonctionnelles et personnalisables, ces incroyables solutions de design joignent le multisensoriel à l'esthétique pour répondre à vos désirs de relaxation.

*Praktisch, multifunctioneel, met een uitgebreide keuze uit verschillende opties. Deze design cabines verenigen functionaliteit met multisensorische ervaringen om aan elke ontspanningswens te kunnen voldoen.*

Diese komfortablen, funktionalen und individuell anpassbaren Designlösungen vereinen höchste ästhetische Ansprüche mit dem multifunktionalen und multisensorischen Aspekt, um Ihrem Wunsch nach Erholung gerecht zu werden.



# 07

## CABINE MULTIFUNZIONE COMPLETE CUBICLES CABINES DE DOUCHE COMPLETE (STOOM-)CABINES MULTIFUNKTIONSKABINEN

62 SKILL

64 GLAX 2.0

66 EON

92 REVOLUTION



# SKILL

CABINA DOCCIA MULTIFUNZIONE.  
UN MONDO DI BENESSERE  
IN UN'UNICA SOLUZIONE

*MULTIFUNCTIONAL SHOWER ENCLOSURE.  
A WORLD OF WELL-BEING  
IN SINGLE SOLUTION.*

CABINE DE DOUCHE MULTIFONCTION.  
UNE IMMERSION DANS LE MONDE  
DU BIEN-ÊTRE.

*MULTIFUNCTIONELE DOUCHECABINE.  
EEN WERELD VAN WELLNESS IN  
ÉÉN PRODUCT.*

MULTIFUNKTIONSKABINE.  
EINE GANZE WELT DES WOHLBEFINDENS  
IN EINER EINZELLÖSUNG

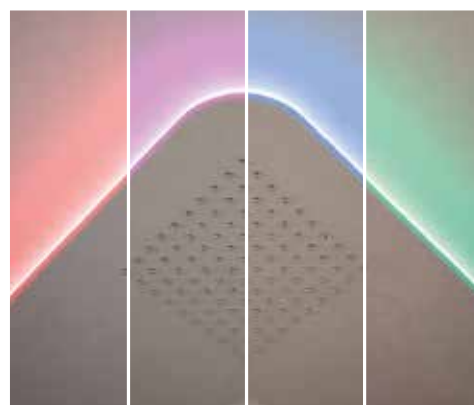

Scelta dei colori per dare carattere al tuo bagno  
*More colours to characterize your bathroom*  
Choix de couleurs pour donner du caractère à votre salle de bains  
*Een keuze aan kleuren om karakter toe te voegen aan uw badkamer*  
Wählen sie ihre Farbe und verleihen Sie Ihrem Badezimmer Charakter



Pannello di controllo soft touch  
*Soft touch control panel*  
Panneau de commande Soft Touch  
*Soft touch bediening*  
Soft-Touch Bedienelemente





SKILL 2P PERLA



SKILL DUAL GRIGIO CHIARO / LIGHT GREY



SKILL A BIANCO / WHITE



# GLAX 2.0

CABINE MULTIFUNZIONE NOVELLINI:  
PER LASCIARE IL MONDO FUORI,  
E TROVARE UNO SPAZIO DI VITALITÀ  
PER IL CORPO, DI RELAX PER LA MENTE  
E DI RIGENERAZIONE DELLO SPIRITO.

*MULTIFUNCTION COMPLETE CUBICLES:  
TO LEAVE THE WORLD OUTSIDE AND FIND  
A PLACE OF VITALITY FOR THE BODY,  
RELAX THE MIND AND SPIRIT REINVIGORATING.*

LES CABINES DE DOUCHE NOVELLINI SONT  
DES ESPACES DE VITALITÉ OÙ VOS SENS  
S'ÉVADENT, VOTRE ESPRIT SE RELAXE ET  
VOTRE CORPS SE RÉGÈNÈRE.

*MULTIFUNCTIONELE DOUCHECABINES:  
DE IDEALE PLEK OM DE WERELD EVEN  
BUITEN TE SLUITEN EN LICHAAM EN GEEST  
VOLLEDIG TE ONSPANNEN.*

NOVELLINI MULTIFUNKTIONSKABINEN:  
DESIGN, FUNKTION, TECHNIK-  
FÜR WOHLBEFINDEN TAG FÜR TAG.



Ripiano porta-oggetti  
Soap holder  
Etagère porte-objets  
Planchet  
Ablage



Pannello di controllo soft touch  
Soft touch control panel  
Panneau de commande Soft Touch  
Soft touch bedienung  
Soft-Touch Bedienelemente



GLAX 2 2.0 2P CORDA



GLAX 2 2.0 A TOTAL WHITE



GLAX 2 2.0 G+F WHITE



# EON

L'ESCLUSIVITÀ DEI SISTEMI  
BENESSERE NOVELLINI  
DALLE LINEE SINUOSE ED ELEGANTI.

*THE EXCLUSIVITY  
OF NOVELLINI WELL BEING SYSTEMS  
OF SINUOUS AND ELEGANT LINES.*

L'EXCLUSIVITÉ DES SYSTÈMES  
DE BIEN-ÊTRE NOVELLINI  
AUX LIGNES SINUEUSES ET ÉLÉGANTES.

*EXCLUSIEVE WELLNESS SYSTEMEN  
VAN NOVELLINI MET VLOEIENDE,  
ELEGANTE LIJNEN.*

DIE EXKLUSIVITÄT DER NOVELLINI  
WELLNESS SYSTEME, MIT ELEGANTEN  
UND GESCHMEIDIGEN LINIEN.



Sistema Cromolight Novellini  
*Novellini Chromolight system*  
Système Chromolight Novellini  
*Novellini Chromolight systeem*  
Chromolight system



Sistema di idromassaggio verticale a nebulizzazione  
*Vertical hydromassage with new jets*  
Système d'hydromassage vertical à nébulisation  
*Verticale hydromassage: verneveling*  
Vertikale Hydromassagedüsen



EON 2P 120x90



EON A 100x80



EON GF90

Immagina un'esperienza rigenerante a 360°, capace di risvegliare corpo e rivitalizzare lo spirito. Con la vasca da bagno ti regali un momento di puro relax e dai forma al tuo spazio in cui colori, lusso e forme si fondono in un ambiente unico e dal carattere deciso.

*Imagine a 360° regenerating experience, able to awake the body and revitalize the spirit. With Novellini bathtub you can enjoy a moment of pure relaxation and give shape to your space where colors, luxury and shapes come together in a unique environment with a strong character.*

Avec les baignoires Novellini, offrez-vous un moment de pure détente et donnez du style à votre espace où les couleurs, le luxe et les formes se rencontrent dans un environnement unique au caractère fort.

*Trakteer jezelf met een Novellini bad op een heerlijk moment van ontspanning en geef stijl aan de badkamer waar luxe en vorm samenkomen in een uniek product met een sterk karakter.*

Stellen Sie sich eine 360°-Regeneration vor, die den Körper zu neuem Leben erweckt und den Geist wiederbelebt. Die Badewanne schenkt Ihnen Momente höchster Entspannung und verleiht ihrem Raum Gestalt, in der sich Farben, Luxus und Formen auf einzigartige und überzeugende Weise miteinander vereinen.





# 08

## VASCHE BATHTUBS BAIGNOIRES BADEN BADEWANNEN

70	INFINITIVE
72	SHIP
74	DIVINA DUAL
76	DIVINA
78	SENSE DUAL
80	SENSE 3-4
82	CALOS 2.0
84	IRIS



# INFINITIVE

QUANDO IL DESIGN DIVENTA RELAX  
*WHEN DESIGN BECOMES RELAXATION*  
QUAND DESIGN DEVIENT RELAX  
*ALS DESIGN ONTSPANNING WORDT*  
WENN DESGIN ZUR ENTSPANNUNG WIRD

## NOVOTECH



**AVANGUARDIA, CREATIVITÀ E RESISTENZA**  
Novotech il solid surface di nuova generazione. Omogeneo in tutto il suo spessore, piacevole al tatto e capace di creare un impatto visivo completamente nuovo, in perfetta armonia con il design essenziale di Novellini. La sintesi di una eccellenza.

**AVANT-GARDE, CREATIVITY AND STRENGTH**  
*Novotech, the new-generation solid surface. Even thickness all over, pleasant to the touch and capable of creating an entirely new visual impact in perfect harmony with Novellini's understated design. Excellence in a nutshell.*

**SOLID SURFACE - DURABLE ET FIABLE**  
Le matériau innovant et extraordinaire Novotech se trouve en parfaite harmonie avec le design contemporain de Novellini. Novotech est synonyme de durabilité, stabilité, qualité et est agréable au toucher.

**SOLID SURFACE - DUURZAAM EN BETROUWBAAR**  
*Het innovatieve en bijzondere materiaal Novotech is in perfecte harmonie met het eigentijdse ontwerp van Novellini. Novotech staat voor duurzaamheid, stabiliteit, kwaliteit en is aangenaam om aan te raken.*

**AVANTGARDE, KREATIVITÄT UND STÄRKE**  
Novotech, die neue Generation robuster Oberflächen. Gleichmäßige Materialstärke am ganzen Produkt, angenehm in der Haptik und in der Lage, eine völlig neue visuelle Wirkung in perfekter Harmonie mit Novellinis dezentem Design zu erschaffen. Exzellenz auf den Punkt gebracht.



### NATURAL AIR

Un bagno d'ossigeno rilassante  
*A relaxing oxygen bath*  
Un bain d'oxygène relaxant  
*Een ontspannend zuurstofbad*  
Ein Sauerstoffbad das entspannt



Mobile per vasca: tecnologia ed estetica  
*Bathtub unit: technology and aesthetic appeal*  
Meuble pour baignoire: technologie et esthétique  
*Console voor bad: technologie en esthetiek*  
Badwanne : Technik und Ästhetik







# SHIP

ISPIRAZIONE, ARMONIA E RESISTENZA.  
RISVEGLIA I TUOI SENSI CULLANDOTI.

*INSPIRATION, HARMONY AND STRENGTH.  
REVIVE AND INDULGE YOUR SENSES.*

INSPIRATION, HARMONIE ET RÉSISTANCE.  
LAISSEZ-VOUS BERCEUR POUR ÉVEILLER VOS SENS.

*INSPIRATIE, HARMONIE EN SYMMETRIE.  
ZIE UIT NAAR VOLLEDIGE ONTSPANNING.*

INSPIRATION, HARMONIE UND STÄRKE  
WIEDERBELEBUNG UND VERWÖHNUNG  
DER SINNE.



## NOVOTECH

AVANGUARDIA, CREATIVITÀ E RESISTENZA

Novotech il solid surface di nuova generazione. Omogeneo in tutto il suo spessore, piacevole al tatto e capace di creare un impatto visivo completamente nuovo, in perfetta armonia con il design essenziale di Novellini. La sintesi di una eccellenza.

*AVANT-GARDE, CREATIVITY AND STRENGTH*

*Novotech, the new-generation solid surface. Even thickness all over, pleasant to the touch and capable of creating an entirely new visual impact in perfect harmony with Novellini's understated design. Excellence in a nutshell.*

SOLID SURFACE - DURABLE ET FIABLE

Le matériau innovant et extraordinaire Novotech se trouve en parfaite harmonie avec le design contemporain de Novellini. Novotech est synonyme de durabilité, stabilité, qualité et est agréable au toucher.

*SOLID SURFACE - DUURZAAM EN BETROUWBAAR*

*Het innovatieve en bijzondere materiaal Novotech is in perfecte harmonie met het eigentijdse ontwerp van Novellini. Novotech staat voor duurzaamheid, stabiliteit, kwaliteit en is aangenaam om aan te raken.*

AVANTGARDE, KREATIVITÄT UND STÄRKE

Novotech, die neue Generation robuster Oberflächen. Gleichmäßige Materialstärke am ganzen Produkt, angenehm in der Haptik und in der Lage, eine völlig neue visuelle Wirkung in perfekter Harmonie mit Novellinis dezentem Design zu erschaffen. Exzellenz auf den Punkt gebracht.



### NATURAL AIR

Un bagno d'ossigeno rilassante  
*A relaxing oxygen bath*  
Un bain d'oxygène relaxant  
*Een ontspannend zuurstofbad*  
Ein Sauerstoffbad das entspannt



Mobile per vasca: tecnologia ed estetica  
*Bathtub unit: technology and aesthetic appeal*  
Meuble pour baignoire: technologie et esthétique  
*Console voor bad: technologie en esthetiek*  
Badwanne : Technik und Ästhetik





# DIVINA DUAL

DESIGN ESSENZIALE  
DAL TRATTO LINEARE E DETERMINATO,  
AMPIE DIMENSIONI, PROFONDA  
ABITABILITÀ E BORDI ERGONOMICI

*MINIMALIST AND ESSENTIAL DESIGN,  
GRAND, DEEP AND ERGONOMIC.*

DESIGN HARMONIEUX, PROFONDEUR  
CONFORTABLE, FORMES LINÉAIRES,  
BORDS ERGONOMIQUES.

*MODERN DESIGN MET STRAKKE LIJNEN,  
ROYALE AFMETINGEN EN  
ERGONOMISCHE RANDEN.*

KLARE UND DEFINIERTE FORMGEBUNG  
UND ESSENTIELLES DESIGN,  
GROSSZÜGIGER INNENRAUM UND  
ERGONOMISCHER WANNENRAND.

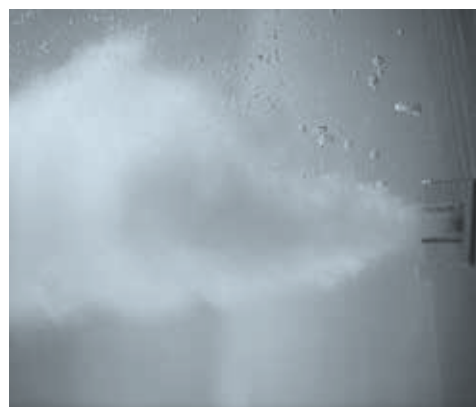

Natural Air una nuvole di micro-bolle d'aria  
*Natural Air with a cloud of micro-air bubbles*  
*Natural Air avec un nuage de micro-bulles d'air*  
*Natural Air met een wolk van micro-bubbels*  
Massage system Natural Air



Pannello di controllo soft touch  
*Soft touch control panel*  
*Commande sensitive Soft Touch*  
*Soft touch bediening*  
Soft-Touch Bedienelemente



DIVINA DUAL

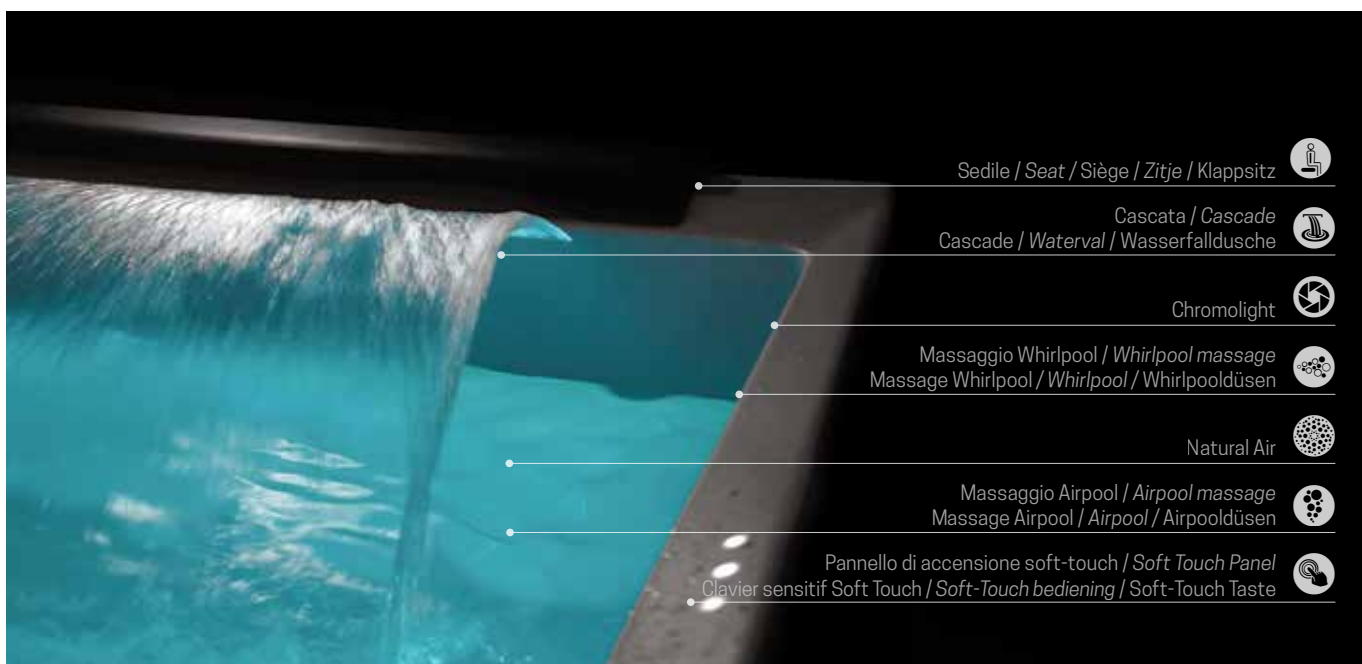

Sedile / Seat / Siège / Zitje / Klappsitz 

Cascata / Cascade  
Cascade / Waterval / Wasserfalldusche 

Chromolight 

Massaggio Whirlpool / Whirlpool massage  
Massage Whirlpool / Whirlpool / Whirlpoldüsen 

Natural Air 

Massaggio Airpool / Airpool massage  
Massage Airpool / Airpool / Airpoldüsen 

Pannello di accensione soft-touch / Soft Touch Panel  
Clavier sensible Soft Touch / Soft-Touch bediening / Soft-Touch Taste 



DIVINA



DIVINA F



DIVINA C



DIVINA O



# SENSE DUAL

VIVI IL PIACERE DI UN BAGNO  
RIVITALIZZANTE O CONCEDITI  
UN MOMENTO DI RELAX E RECUPERA  
LE ENERGIE CON I SISTEMI WELLNESS.

*LIVE THE PLEASURE OF A REFRESHING  
BATH OR ENJOY A MOMENT  
OF RELAXATION WITH NOVELLINI  
WELLNESS SYSTEMS*

VIVEZ LE PLAISIR D'UN BAIN REVITALISANT  
OU ACCORDEZ-VOUS UN MOMENT  
DE DÉTENTE ET DE RÉCUPÉRATION,  
SEUL OU À DEUX.

*BELEEF HET GENOEGEN VAN EEN  
VERKWIKKEND BAD OF GUN JEZELF  
EEN ONTSPANNINGSMOMENT  
MET HET WELLNESS-SYSTEEM.*

GENIESSEN SIE EIN REVITALISIERENDES  
BAD UND GÖNNEN SIE SICH EINEN  
MOMENT DER ENTSPANNUNG,  
TANKEN SIE NEUE ENERGIE DURCH  
DIE WELLNESS- SYSTEME.



Poggiatesta in vera pelle bianca  
Head rest in true white skin  
Repose-tête en cuir  
2 Wit leren hoofdsteunen  
Nackenstütze in weißem Echtleder



Sistema audio con radio RDS e collegamento bluetooth  
Sound system with RDS radio and Bluetooth connection  
Système audio avec radio RDS et raccordement Bluetooth  
Audiosysteem met Bluetooth  
Radio RDS Stereo mit 4 Lautsprecher und bluetooth





# SENSE 3 SENSE 4

LA PIÙ AMPIA SCELTA  
DEI SISTEMI IDROMASSAGGIO:  
DIVERSI MODI DI VIVERE IL TUO BAGNO.

*THE WIDEST CHOICE OF NOVELLINI  
HYDROMASSAGE VERSION SYSTEMS:  
MANY WAYS TO MAKE THE MOST  
OUT OF YOUR BATHROOM.*

LE PLUS GRAND CHOIX DE SYSTÈMES  
DE BIEN-ÊTRE NOVELLINI :  
DIFFÉRENTES FAÇONS DE VIVRE  
LA SALLE DE BAINS.

*HET GROOTSTE ASSORTIMENT VAN  
HYDROMASSAGESYSTEMEN:  
VERSCHILLENDE MANIEREN  
OM VAN UW BAD TE GENIETEN.*

DIE GRÖSSTE AUSWAHL AN  
HYDROMASSAGE SYSTEMEN:  
VERSCHIEDENE ARTEN,  
UM IHR BAD ZU ERLEBEN.



SENSE 3



SENSE 4



Telecomando touch screen  
Touch screen remote control  
Télécommande tactile  
Afstandsbediening met Touch screen  
Touchscreen Fernbedienung zur Steuerung aller Funktionen

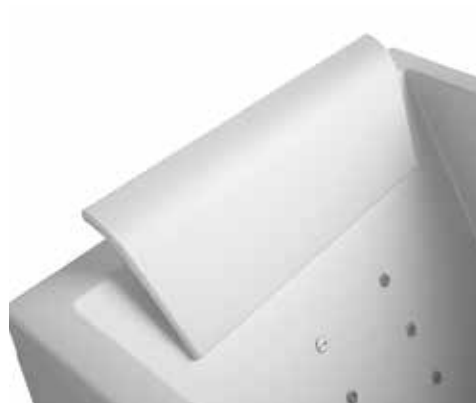

Poggiatesta in materiale atossico e idrorepellente  
White head rest in EVA, water proof, antibacterial and nontoxic  
Repose-tête en matière étanche et antibactérienne  
Waterdichte en antibacteriële hoofdsteen  
Nackenkstütze aus wasserfestem und atoischem EVA Material





# CALOS 2.0

VASCA RETTANGOLARE  
DALLE FORME SEMPLICI E REGOLARI,  
CON SISTEMA IDROMASSAGGIO NOVELLINI.

*RECTANGULAR BATHTUB  
WITH SIMPLE AND REGULAR SHAPES,  
WITH THE NOVELLINI WHIRLPOOL SYSTEM.*

BAIGNOIRE RECTANGULAIRE  
AUX FORMES SIMPLES ET RÉGULIÈRES  
QUI PEUT ÊTRE ÉQUIPÉE D'UN SYSTÈME  
D'HYDROMASSAGE NOVELLINI.

*RECHTHOEKIG BAD MET EENVOUDIGE  
EN GELIJKMATIGE VORMEN,  
MET HET HYDROMASSAGESYSTEEM  
VAN NOVELLINI.*

RECHTECKIGE WANNE  
MIT EINFACHER LINIENFÜHRUNG,  
ERHÄLTICH MIT DEN NOVELLINI  
MASSAGESYSTEMEN.



Pannello elettronico con funzioni Hydro Sequence  
*Electronic panel with Hydro functions*  
Clavier de commande électronique  
*Elektronisch Bedieningspaneel*  
Elektronisches Bedienpaneel mit Hydro Sequence



Fondo liscio  
*Smooth lower surface*  
Fond lisse  
*Vlakte bodem*  
Glatter Wannenboden





# IRIS

FACILITÀ DI ACCESSO E POSSIBILITÀ  
DI GODERE INSIEME IL BENESSERE DELLA  
VASCA E LA VITALITÀ DELLA DOCCIA.

*EASY-ACCESS BATHTUB WITH COMBINED  
BATHSCREEN TO MAXIMIZE THE WELL-  
BEING OF THE BATH AND THE VITALITY  
OF THE SHOWER.*

FACILITÉ D'ACCÈS ET POSSIBILITÉ DE  
PROFITER DU CONFORT DE LA BAIGNOIRE  
ET DE LA PRATICITÉ DE LA DOUCHE.

*EENVOUDIGE TOEGANG EN DE  
MOGELIJKHEID OM TE GENIETEN  
VAN HET COMFORT VAN EEN BAD  
OF DE ENERGIE VAN EEN DOUCHE.*

EINFACHER ZUGANG UND DIE  
MÖGLICHKEIT, DAS WOHLBEFINDEN  
DER BADEWANNE UND DIE VITALITÄT  
DER DUSCHE GEMEINSAM ZU NUTZEN.



Sportello per ingresso agevolato  
*Mechanical door lock for total safety*  
Porte pour entrée facile  
*Deur met mechanische sluiting*  
Glastüre mit mechanischem Verschluss



Il poggiatesta diventa seduta in un gesto  
*Removable seat/Head rest*  
Repose-tête transformable en siège  
*Hoofdsteun/Zitje*  
Nackenstütze/Sky Sitzplatte

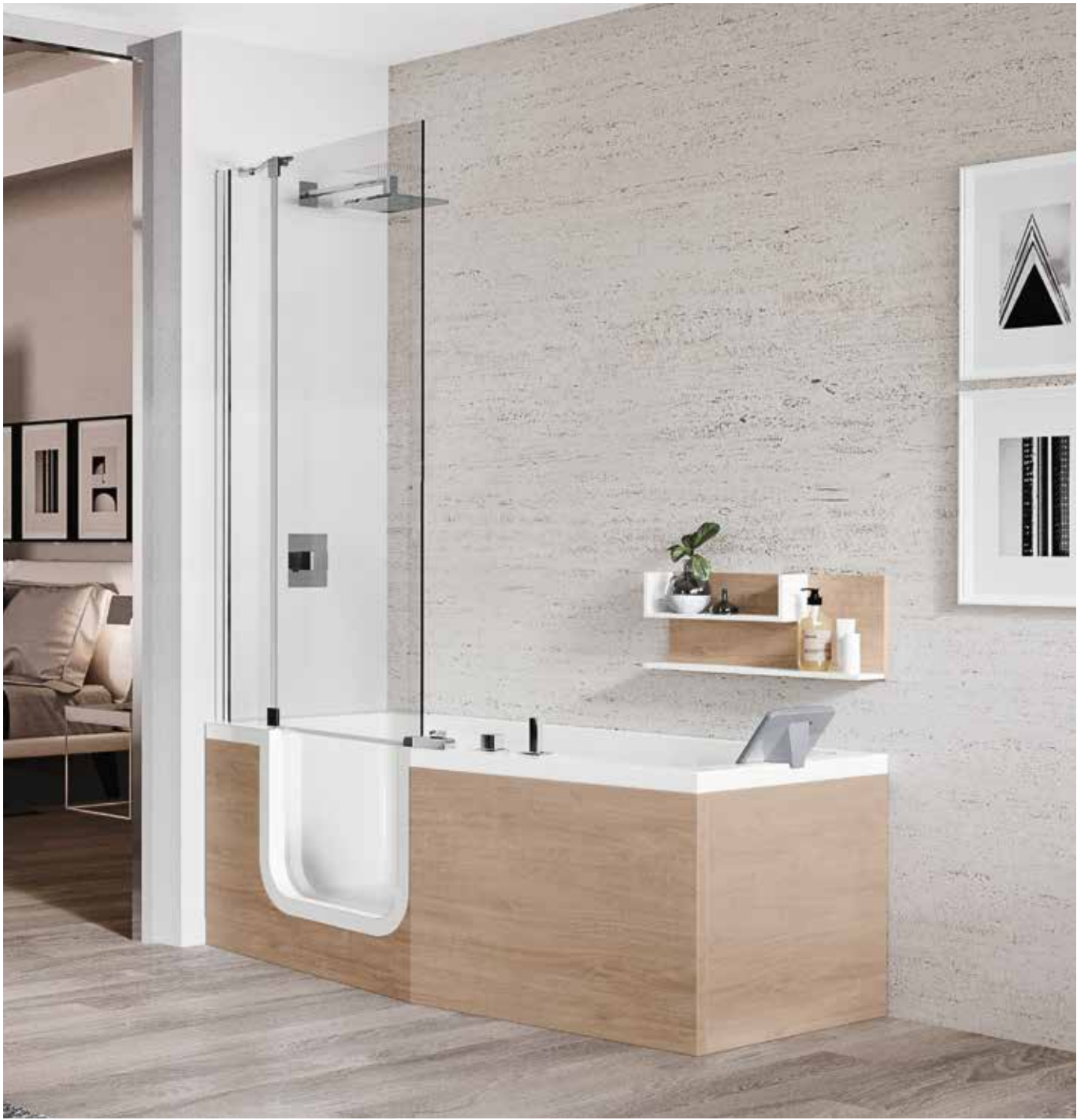

A volte, per osservare il mondo con occhi diversi non c'è bisogno di viaggiare. A volte, per ammirare la bellezza di un panorama non c'è bisogno di aspettare un tramonto. Con la nostra nuova Divina Outdoor, infatti, puoi fare tutto questo semplicemente dal terrazzo di casa.

*You don't always need to travel to see the world in a different way. Nor do you need to wait for a dazzling sunset to appreciate a view. With our Divina Outdoor your terrace becomes the ultimate viewing platform.*

Il n'est pas toujours nécessaire de voyager pour voir le monde d'une autre façon. Vous n'avez pas non plus besoin d'attendre un coucher de soleil éblouissant pour apprécier une vue. Avec notre Divina Outdoor, votre terrasse devient l'ultime plateforme d'observation.

*Je hoeft niet altijd ver te reizen om de wereld met andere ogen te bekijken. Met onze Divina Outdoor wordt je eigen tuin of terras de perfecte plek voor ontspanning en reflectie.*

Man muss nicht immer reisen, um die Welt mit anderen Augen zu sehen. Sie brauchen auch nicht auf einen strahlenden Sonnenuntergang zu warten um eine Aussicht zu schätzen zu lernen. Mit unserem Divina Outdoor, wird Ihre Terrasse zur ultimativen Aussichtsplattform.

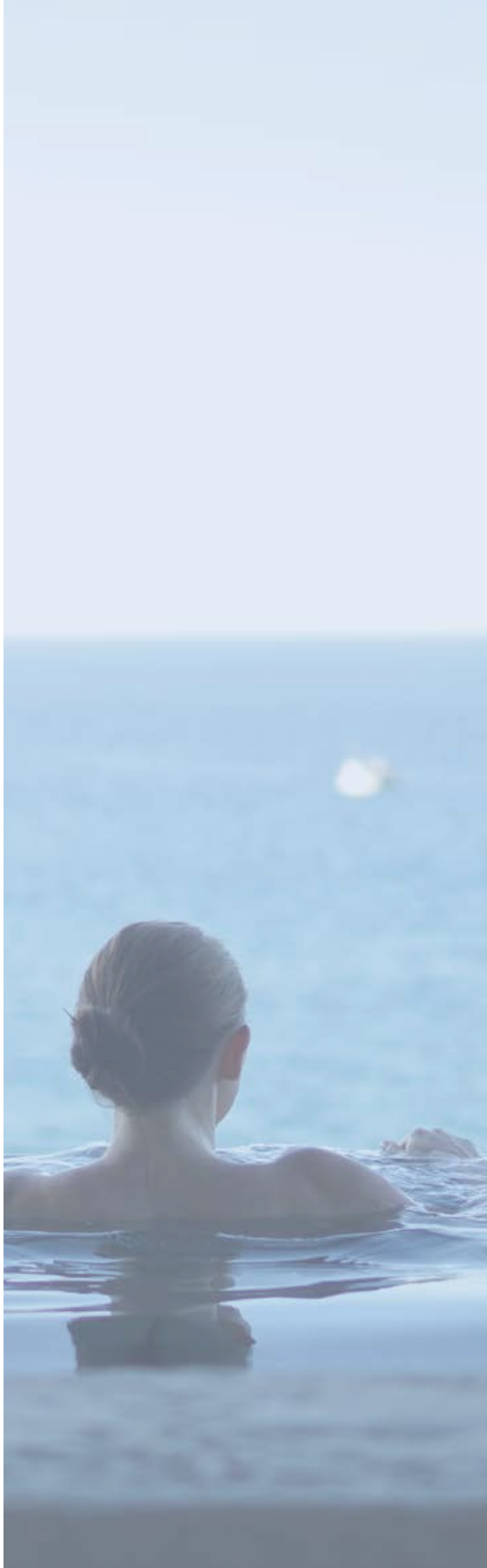



09

**SPA IDROMASSAGGIO  
WHIRLPOOL BATHS  
BAIGNOIRES SPA  
SPA BADEN  
WHRPOOL BAD**

88 DIVINA OUTDOOR



# DIVINA OUTDOOR

NOVELLINI OLTRE I CONFINI:  
UN RELAX PSICO-FISICO TOTALE.

NOVELLINI ONE STEP BEYOND  
TOTAL MENTAL AND PHYSICAL RELAXATION.

NOVELLINI AU-DELÀ DES LIMITES :  
RELAXATION TOTALE DU CORPS ET DE L'ESPRIT.

TOTALE ONTSPANNING  
VAN LICHAAM EN GEEST.

NOVELLINI GEHTE EINEN SCHRITT WEITER  
TOTALE GEISTIGE UND KÖRPERLICHE  
ENTRSPANNUNG.

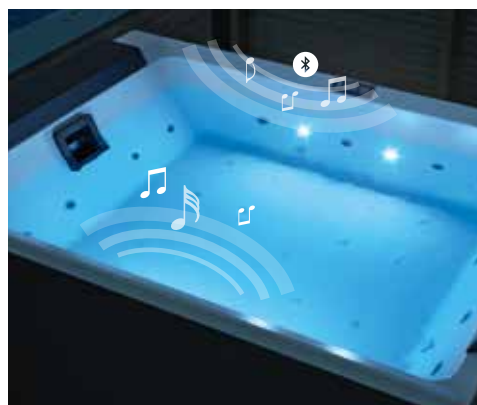

Sistema Cromolight & Audio  
*Chromolight & Audio System*  
Système Chromolight & Audio  
*Chromolight & audiosysteem*  
Lichttherapie & Audio System



## NATURAL AIR

Un bagno d'ossigeno rilassante  
*A relaxing oxigen bath*  
Un bain d'oxygène relaxant  
*Een ontspannend zuurstofbad*  
Ein Sauerstoffbad das entspannt



## AQUACLEAN

Il nuovo sistema di pulizia acqua  
*The water cleansing system*  
Nouveau système de traitement d'eau  
*Het nieuwe waterbehandelingsysteem*  
Das Reinigungssystem



# DIVINA OUTDOOR

Fuori dagli schemi con Divina Outdoor, affascinante novità 2020 in equilibrio tra realtà e futuro. Avanguardia, tecnologia, stile, essenzialità e comfort permettono di vivere un'esperienza multisensoriale unica, mettendo in sinergia corpo, mente e ambiente.

*One step beyond with the DIVINA OUTDOOR whirlpool bath, the amazing new entry for 2020 combining reality with the future. Avant-garde design, technology, style, simple lines and comfort are combined to provide you with a unique multi-sensory experience, creating synergy between mind, body and environment.*

DIVINA OUTDOOR, une fascinante nouveauté 2020 en équilibre entre réalité et avenir. Technologie d'avant-garde, style, simplicité et confort vous permettent de vivre une expérience multisensorielle unique, alliant corps, esprit et design.

*DIVINA OUTDOOR, een fascinerende noviteit met geavanceerde technologie, stijl, eenvoud en comfort. Deze kenmerken zorgen voor een unieke multisensorische ervaring voor lichaam en geest.*

Einen Schritt weiter mit der DIVINA OUTDOOR-Whirlwanne, der Neuentwicklung im Jahr 2020, die Realität mit der Zukunft verbindet. Avantgardistisches Design, Technologie und Stil, sowie einfache Linien und Komfort wurden in Einklang gebracht, um Ihnen eine einzigartige multisensorische Erfahrung zu bieten und die Synergie zwischen Geist, Körper und Umwelt herzustellen.

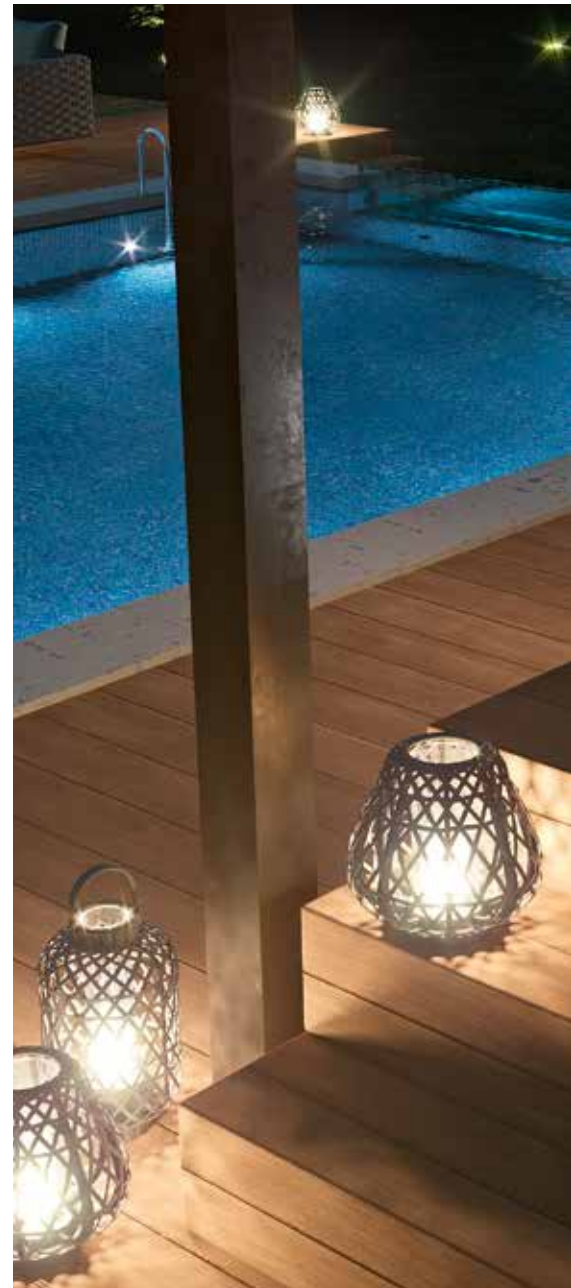

Pannello di controllo  
Control panel  
Panneau de commande  
Bedieningspaneel  
Elektronisches Bedienpaneel

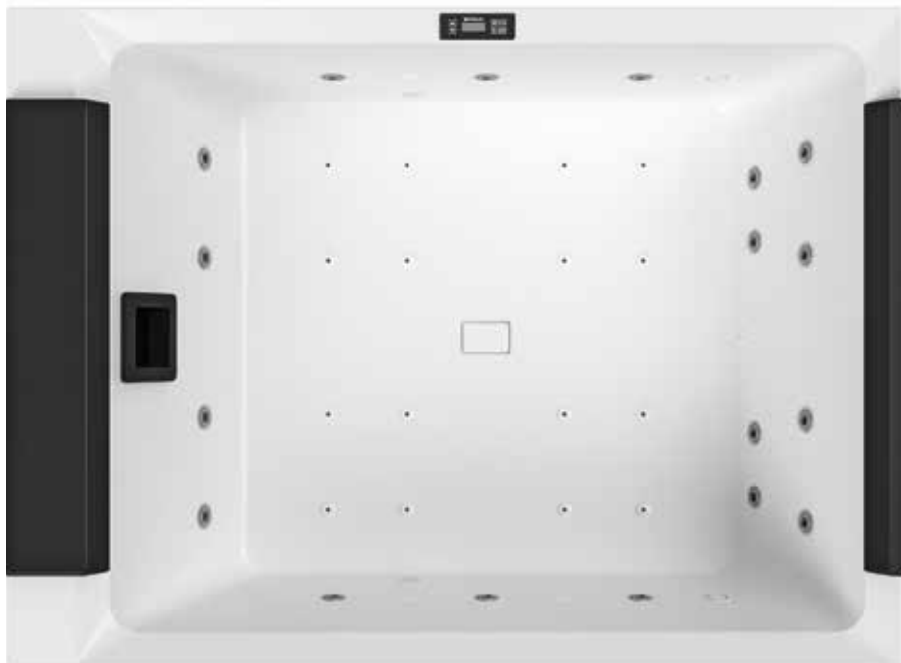



# REVOLUTION

REVOLUTION È LA RISPOSTA ALLE ESIGENZE DI SPAZIO E ORDINE. PER UN'AMBIENTE BAGNO ELEGANTE E SICURO.

*REVOLUTION IS THE ANSWER TO THE NEED FOR SPACE AND STORAGE. FOR AN ELEGANT, SAFE BATHROOM.*

REVOLUTION EST LA RÉPONSE AUX EXIGENCES D'ESPACE ET DE RANGEMENT. POUR UNE SALLE DE BAINS ÉLÉGANTE ET SÉCURISÉE.

*REVOLUTION IS HET ANTWOORD OP DE BEHOEFTE AAN RUIMTE EN ORDE. VOOR EEN ELEGANTE EN VEILIGE BADKAMER.*

REVOLUTION IST DIE ANTWORT AUF DIE ANFORDERUNGEN AN PLATZ UND ORDNUNG. FÜR EIN ELEGANTES UND SICHERES BAD.

Revolution è la cabina doccia ideale per la ristrutturazione della vecchia vasca da bagno, personalizzabile e facile da installare senza l'interventi di muratura. Lavori di muratura ridotti al minimo. Adattabile a qualsiasi tipo di bagno e ideale per la sostituzione della vasca.

*The Revolution shower cubicle is ideal for replacing your old bath; extremely easy to install with no or minimal tiling required. Each product can be customized and adapted to any type of bathroom.*

Revolution est la cabine de douche idéale pour remplacer une baignoire, personnalisable et facile à installer sans effectuer de gros travaux et sans remplacer le carrelage. Elle peut être combinée avec un meuble et s'adapte à tout type de salles de bains.

*Met de Revolution cabines kan men in korte tijd een bestaand bad vervangen door een douche. De cabines zijn geheel naar wens samen te stellen en gemakkelijk te installeren zonder veel breekwerk. Ook het tegelen wordt tot een minimum beperkt.*

Als praktischer Badewannenersatz kann Sie auf die individuellen Stilwünsche abgestimmt und problemlos eingebaut werden. Geringfügige Mauerarbeiten - an jedes Bad anpassbar - ideal bei Austausch der Badewanne auf Duschkabine.







# KUADRA H IN ART

SOLUZIONI CHE TRASFORMANO NOVELLINI  
UNA VERA E PROPRIA "OFFICINA ARTISTICA"  
PER LA DECORAZIONE DELLE SUPERFICI IN VETRO.

*SOLUTIONS WHICH TRANSFORM NOVELLINI  
INTO A GENUINE "ARTISTIC WORKSHOP"  
FOR DECORATING GLASS SURFACES.*

DES SOLUTIONS QUI TRANSFORMENT NOVELLINI  
EN UN VÉRITABLE « ATELIER ARTISTIQUE »  
DE DÉCORATION DES SURFACES VITRÉES.

*MOGELIJKHEDEN VOOR DECORATIE VAN GLAS  
DIE DE KUNSTZINNIGE INSLAG VAN NOVELLINI TOT  
UITDRUKKING BRENGEN.*

LÖSUNGEN, DIE NOVELLINI ZU EINER ECHTEN  
„KUNSTWERKSTATT“ FÜR DIE DEKORATION  
DER OBERFLÄCHEN AUS GLAS MACHEN.

I nuovi decori IN ART ideati da Novellini, sono disponibili nella collezione degli spazi doccia KUADRA H. Le stesse immagini IN ART sono state riprodotte anche sui termoarredi SOLE per creare decori coordinati per la stanza da bagno e per gli altri ambienti della casa. Con Novellini, avete la possibilità di personalizzare il bagno con un'ampia scelta di decori e di misure a vostra disposizione.

*The new IN ART decors created by Novellini, are available in the KUADRA H. shower rooms collection. The same IN ART images have also been reproduced on the SOLE decorative radiators to create coordinated decors for the bathroom and the other rooms of the house. Novellini gives you the possibility to personalise your bathroom offering you a vast selection of decors and sizes.*

Les décors IN ART de Novellini sont disponibles avec les parois walk-in Kuadra H. Les décors In ART sont aussi reproduits sur les radiateurs SOLE pour créer des espaces coordonnés. Novellini vous offre une possibilité de personnaliser votre salle de bains en offrant un large choix de décors et de dimensions.

*Met In Art kan men een inloopdouche Kuadra en radiator Sole personaliseren met een eigen foto of een motief uit ons assortiment. Neem contact op met Novellini voor informatie over alle mogelijkheden van In Art.*

Die von Novellini neu gestalteten In-Art Dekore sind nun auf den Walk-In Lösungen der Serie Kuadra H erhältlich. Die gleichen In-Art Dekore werden auch auf den Sole Heizkörpern angeboten, um somit ein harmonisches Konzept im Badezimmer und auch in den anderen Räumen des Hauses zu erzielen. Mit Novellini haben Sie die Möglichkeit einer umfangreichen Dekorauswahl und Größen zur Personalisierung Ihres Badezimmers.







# SOLE

IL TERMOARREDO IDEALE PER IL BAGNO E NON SOLO:  
GRAZIE ALLA SUA VERSATILITÀ  
SI ADATTA A QUALUNQUE AMBIENTE E STILE.

*THE SOLE RADIATOR IS PERFECT  
NOT ONLY FOR BATHROOMS.  
MAKES IT SUITABLE FOR ANY AMBIENCE AND STYLE.*

RADIATEUR IDÉAL POUR LA SALLE DE BAINS.  
MAIS AUSSI POUR TOUTES LES AMBIANCES  
ET TOUS LES STYLES.

*DE ELEKTRISCHE RADIATOR SOLE IS IDEEAAL VOOR  
DE BADKAMER MAAR OOK VOOR ANDERE RUIMTES  
DANKZIJ DE VELE STIJLMOGELIJKHEDEN.*

DIE IDEALE HEIZVORRICHTUNG FÜR DAS BAD  
UND DARÜBER HINAUS: PASST SICH DANK SEINER  
VIELSEITIGKEIT JEDEM RAUM UND STIL AN.



Telecomando con regolazione temperatura o display  
estraibile con tecnologia touch screen.

*Touch screen remote control or long duration remote  
control with temperature sensor.*

Commande tactile escamotable ou télécommande  
avec contrôle de la température.

*Met uitschuifbaar touch screen display  
of met afstandsbediening.*

Fernbedienung mit Thermostat oder Versenkbares  
Display mit Touchscreen Technologie.





An aerial photograph of a beach with waves crashing onto the shore. The water is a deep teal color, and the sand is a light beige. The waves are white and foamy, creating a dynamic contrast with the darker water. The text is overlaid on the upper portion of the image.

RELAX  
RENEW  
REFRESH

**NOVELLINI** CONTEMPORARY WELLNESS



  
Designed and  
manufactured  
in **ITALY**



[www.novellini.com](http://www.novellini.com)



[www.novellini.com/facebook](http://www.novellini.com/facebook)



[www.novellini.com/instagram](http://www.novellini.com/instagram)



[www.novellini.com/YouTube](http://www.novellini.com/YouTube)



[www.novellini.com/Linkedin](http://www.novellini.com/Linkedin)



[www.novellini.com/Pinterest](http://www.novellini.com/Pinterest)