



# SOFFIONI *SHOWER HEADS*

# AZIMUT

\_2017

design

GI-RA

Modello e design registrato, brevetto depositato

*Registered model and design, patent filed*

Un cilindro perfetto, compatto, essenziale, preciso, una forma che rimanda immediatamente ad altre funzioni, un'immagine che è la perfetta sintesi di tecnologia e design: AZIMUT è il soffione a soffitto e a parete in acciaio inox e Delrin nero, che ha nello snodo speciale il cuore del progetto. Un dettaglio tecnico che diventa estetico, un particolare che fa la differenza, un concept che mette la funzionalità evoluta al primo posto. Lo snodo permette infatti al soffione di ruotare e quindi orientare il getto d'acqua per più di 180° rispetto a un asse. Una caratteristica che ne moltiplica le possibilità d'utilizzo garantendo una maggiore flessibilità di installazione. AZIMUT si può applicare a parete o a soffitto a seconda delle esigenze ed è in grado di orientare il getto d'acqua in base alle caratteristiche fisiche dell'utente per garantire il massimo relax. Un progetto che ridefinisce l'archetipo del soffione, un oggetto che migliora la qualità dello spazio doccia, un dettaglio che riscrive una gestualità consolidata. Lo snodo è stato realizzato con una cremagliera che genera un piacevole effetto a scatto e allo stesso tempo permette di tenere fermo il soffione nella posizione desiderata. Come in tutte le collezioni di antoniolupi l'estetica svolge un ruolo fondamentale nella definizione del progetto. La sofisticata eleganza dell'acciaio satinato, gli equilibri proporzionali misurati e la compattezza della forma ne fanno un oggetto dall'anima contemporanea.

*A perfect cylinder, compact, essential, precise, an image that is the perfect synthesis of technology and design: AZIMUT is the ceiling and wall showerhead in stainless steel and black Delrin with a special rotation which is the heart of the project. A technical detail that becomes aesthetic, a peculiarity that makes the difference, a concept that puts an evolved functionality first. The hinge allows the showerhead to rotate and then direct the jet more than 180°. A feature that multiplies the possibilities of use, providing greater flexibility in the installation. AZIMUT can be applied to the wall or ceiling depending on the needs and is able to orient the jet of water according to the physical characteristics of the user to ensure maximum relaxation. A project that redefines the archetype of the showerhead, an object that improves the quality of the showering space, a detail that rewrites a consolidated gesture. The movement has been made with a device that generates a pleasant snap effect and at the same time keeps the head firm in the desired position. As in all the collections of antoniolupi aesthetics plays a key role in defining the project. The sophisticated elegance of satin steel, measured proportional balance and compactness make it an object of the contemporary soul.*











antoniolupi









acciaio inox satinato  
satin stainless steel

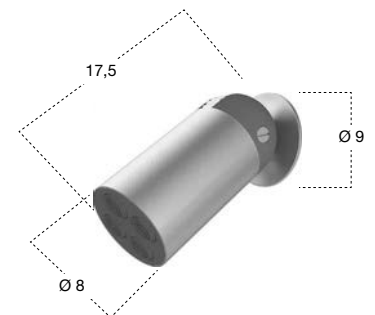

H	P	Ø	art.
9	17,5	8	AZIMUT

Soffione a parete o a soffitto in acciaio inox AISI 304 e Delrin nero, con regolazione del getto, disponibile anche in finitura grafite.

Wall or ceiling showerhead in stainless steel AISI 304 and black Delrin, with jet regulation, also available in graphite finish.

# MINIAZIMUT

\_2018

design

GI-RA

Modello e design registrato, brevetto depositato

*Registered model and design, patent filed*

Un cilindro perfetto, essenziale, preciso, oggi disponibile anche nella versione ridotta, con dimensioni ancora più compatte. Una forma che rimanda immediatamente ad altre funzioni, un'immagine che è la perfetta sintesi di tecnologia e design: MINIAZIMUT è l'evoluzione di AZIMUT, il soffione a soffitto e a parete che rimanda all'immagine di un proiettore luminoso che emette al posto della luce, l'energia vitale dell'acqua. Nel solco di quanto sta avvenendo nel mondo dell'illuminazione con la miniaturizzazione delle sorgenti e la conseguente riduzione delle dimensioni dei corpi, anche AZIMUT si restringe e diventa MINIAZIMUT, anch'esso disponibile nelle finiture Acciaio Inox Satinato o Grafite oltre che in alcune parti in Delrin nero. Un soffione che ha nello snodo speciale il cuore del progetto, un dettaglio tecnico che diventa estetico, un concept che mette la funzionalità evoluta al primo posto. Lo snodo permette infatti al soffione di ruotare e quindi orientare il getto d'acqua per più di 180° rispetto a un asse. Una caratteristica che ne moltiplica le possibilità d'utilizzo garantendo una maggiore flessibilità di installazione. AZIMUT si può applicare a parete o a soffitto a seconda delle esigenze ed è in grado di orientare il getto d'acqua in base alle caratteristiche fisiche dell'utente per garantire il massimo relax. Lo snodo è stato realizzato con una cremagliera che genera un piacevole effetto a scatto e allo stesso tempo permette di tenere fermo il soffione nella posizione desiderata.

*A perfect, essential, precise cylinder, now also available in the reduced version with even more compact dimensions. A form that immediately refers to other functions, an image that is the perfect synthesis of technology and design: MINIAZIMUT is the evolution of AZIMUT, the ceiling and wall showerhead that refers to the image of a luminous projector that emits, instead of light, the vital energy of water. In the wake of what is happening in the lighting world with the miniaturization of the sources and the consequent reduction in body size, AZIMUT also shrinks and becomes MINIAZIMUT, available in Satin Stainless Steel or Graphite finishes and some parts in black Delrin. A showerhead that has the heart of the project in its special joint, a technical detail that becomes aesthetic, a concept that puts evolved functionality in first place. In fact, the joint allows the showerhead to rotate and then orient the jet of water by more than 180 ° with respect to an axis. A feature that multiplies the possibilities of use ensuring greater flexibility of installation. AZIMUT can be applied to the wall or ceiling according to the needs and is able to direct the jet of water according to the physical characteristics of the user to ensure maximum relaxation. The joint has been made with a rack that generates a pleasant snap effect and at the same time allows to hold the showerhead in the desired position.*







acciaio inox satinato  
*satin stainless steel*



grafite  
graphite

H	P	Ø	art.
4,5	8,4	3	MINIAZIMUT

Soffione a parete o a soffitto in acciaio inox AISI 304 e Delrin nero, con regolazione del getto, disponibile anche in finitura grafite.

Wall or ceiling showerhead in stainless steel AISI 304 and black Delrin, with jet regulation, also available in graphite finish.

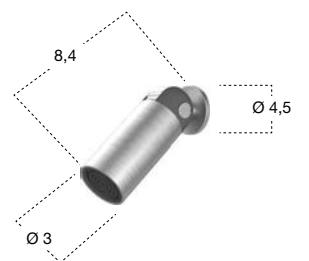

# SPRAY

\_2019

design  
AL Studio



Essenziale nella sua forma geometrica perfetta, elegante nel suo andare oltre qualsiasi velleità decorativa, performante nel saper conferire potenza al getto d'acqua.

Come uno spray, a cui deve il nome, capace di scatenare forza e vigore per un rigenerante relax. Il tutto concentrato in un cilindro dalle dimensioni contenute, minime.

Un diametro di soli 6 cm, un'altezza di 10 cm, per sprigionare un getto potente ed efficace. Spray è il minisoffione da soffitto, realizzato in acciaio inox e delrin nero, che "buca" la superficie per portare benessere nello spazio doccia.

*Essential in its perfect geometrical shape, elegant and performing while conferring power to the water jet.*

*As a spray, hence its name, this small cylinder is the perfect showerhead for a regenerating and relaxing bath.*

*A diameter of only 6 cm with 10 cm height to emanate a strong and effective jet. Spray is a ceiling mini-showerhead in stainless steel and black Delrin, which "drills" the surface to bring wellness in the shower.*

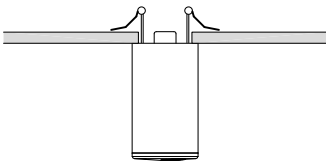

H	Ø	art.
10,6	6	SPRAY

Soffione a soffitto in acciaio satinato inox AISI 304 e Delrin nero.

*Ceiling showerhead in satin stainless steel AISI 304 and black Delrin.*

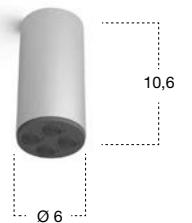



# METEO

\_2011

design

Nevio

Tellatin

Modello e design registrato, brevetto depositato

*Registered model and design, patent filed*

MINIMALISMO

ALTA INNOVAZIONE tecnologica

CROMOTERAPIA

*MINIMALISM*

*HIGH technological INNOVATION*

*CROMOTHERAPY*

Un progetto caratterizzato da estremo rigore che associa minimalismo formale ad alta innovazione tecnologica, uniti nell'obiettivo di trasmettere emozionalità e sensazioni uniche.

*A project characterized by extreme rigor which associates minimalism with a high technological innovative united in conveying emotion and unique sensations.*



METEO,  
LE PREVISIONI DEL TEMPO SI AVVERANO SEMPRE.

*METEO,  
THE WEATHER FORECAST ALWAYS COME TRUE.*

I soffioni METEO sono disponibili con o senza illuminazione a LED RGB.

*The METEO showerheads are available with or without RGB LED lighting.*

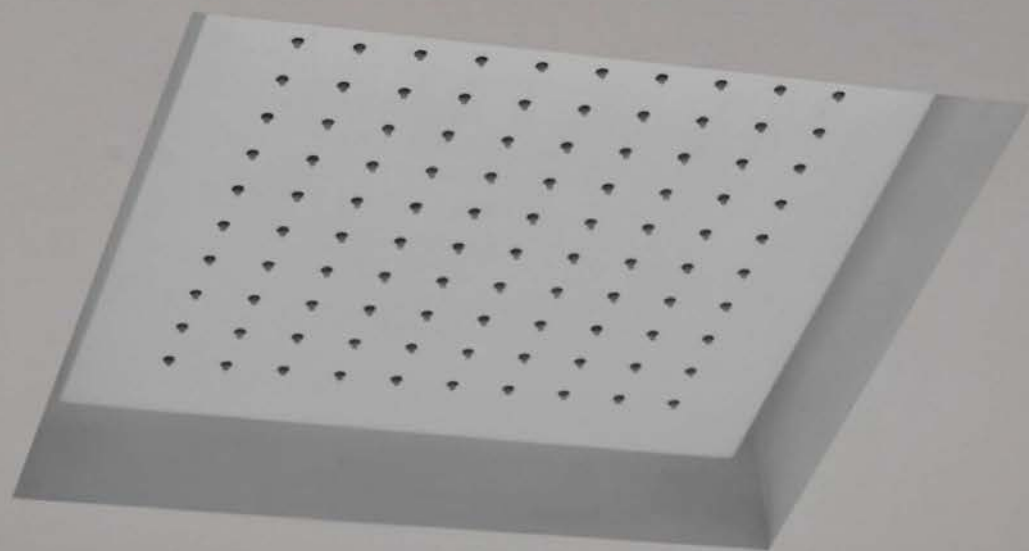

METEO

UNA BELLA DOCCIA  
*A WONDERFUL SHOWER*

Una bella doccia

Uno dei “piccoli” piaceri della vita è farsi una bella doccia all’inizio di un nuovo giorno o alla sera al rientro dal lavoro e perché il piacere sia tale, il getto del soffione deve essere potente al punto giusto, deve avere più funzioni, deve cullarci quando lo desideriamo magari con le micro gocce dei nebulizzatori, o svegliarci e tonificarci con il chiodo e la cascata, quando ne sentiamo il bisogno: solo così infatti possiamo riprodurre in casa quella sensazione di benessere e di relax che possiamo provare in una SPA.

Chi ha inventato il soffione SPA incassato nel soffitto?

antoniolupi, per prima, già nel 2011, ha brevettato METEO, il soffione che riassume in sé tutte le caratteristiche e la ricerca di effetti il più possibile naturali, di una vera e propria SPA: doccia centrale, doccia perimetrale, cascata, chiodo, nebulizzatori ed anche la funzione di cromoterapia, utilizzando luci a LED gestite da un telecomando, tonificanti nelle gradazioni che vanno dal giallo al rosso, energizzanti nei toni del rosso fino al giallo, rilassanti nei toni dal blu al verde, potendo scegliere in tutta la gamma dei colori RGB.

Come in una foresta tropicale, come sotto una cascata o sotto la pioggia

METEO è stato studiato per riprodurre, protetti nel nostro bagno, le sensazioni che la natura può darci: l’ampia superficie, il numero e la disposizione degli ugelli e dei getti, il posizionamento in alto a soffitto, tutto è stato pensato perché fare una doccia possa divenire uno dei momenti più belli della giornata.

La qualità dei materiali e la cura della realizzazione che insieme al design sono tratti distintivi della nostra azienda, assicurano poi durata e facilità di manutenzione, METEO è realizzato in acciaio inossidabile, con lavorazione artigianale di precisione, gli ugelli sono in materiale silconico di alta qualità e anticalcare, sostituibili in caso di usura.

*A wonderful shower*

*One of the “little” pleasures in life is to take a shower at the beginning of a new day or in the evening upon return from work. For it to be pleasing the jet of the showerhead must be powerful at the right point, it must have several functions, it must cradle us when we need it, maybe, with micro drops of nebulizers, or wake us up and invigorate us with a nail jet and a waterfall when we feel the need: only so can we reproduce at home that feeling of well being and relaxation that we can feel at a SPA .*

*Who invented the SPA showerhead embedded in the ceiling*

*antoniolupi, already in 2011 patented METEO, the showerhead that sums up all the characteristics and the search for effects as natural as possible, of a real SPA: central shower, perimeter shower, waterfall, nail jet, nebulizers and also the chromotherapy function using LED lights managed by a remote control, invigorating shades ranging from yellow to red, energizing shades from red to yellow, relaxing shades from blue to green, being able to choose from the entire range of RGB colors.*

*Like in a tropical forest, like under a waterfall or in the rain*

*Meteo was designed to reproduce, protected in our bathroom, the sensations that nature can give us: the large surface, the number and the arrangement of the nozzles and jets, the positioning within the ceiling, everything has been thought out because taking a shower can become one of the most beautiful moments of the day.*

*The quality of the materials and the care of the realization that together with the design are hallmarks of our company ensure durability and ease of maintenance. Meteo is made of stainless steel, with precision craftsmanship, the anti-scale nozzles are made of high quality silicone replaceable in case of wear.*



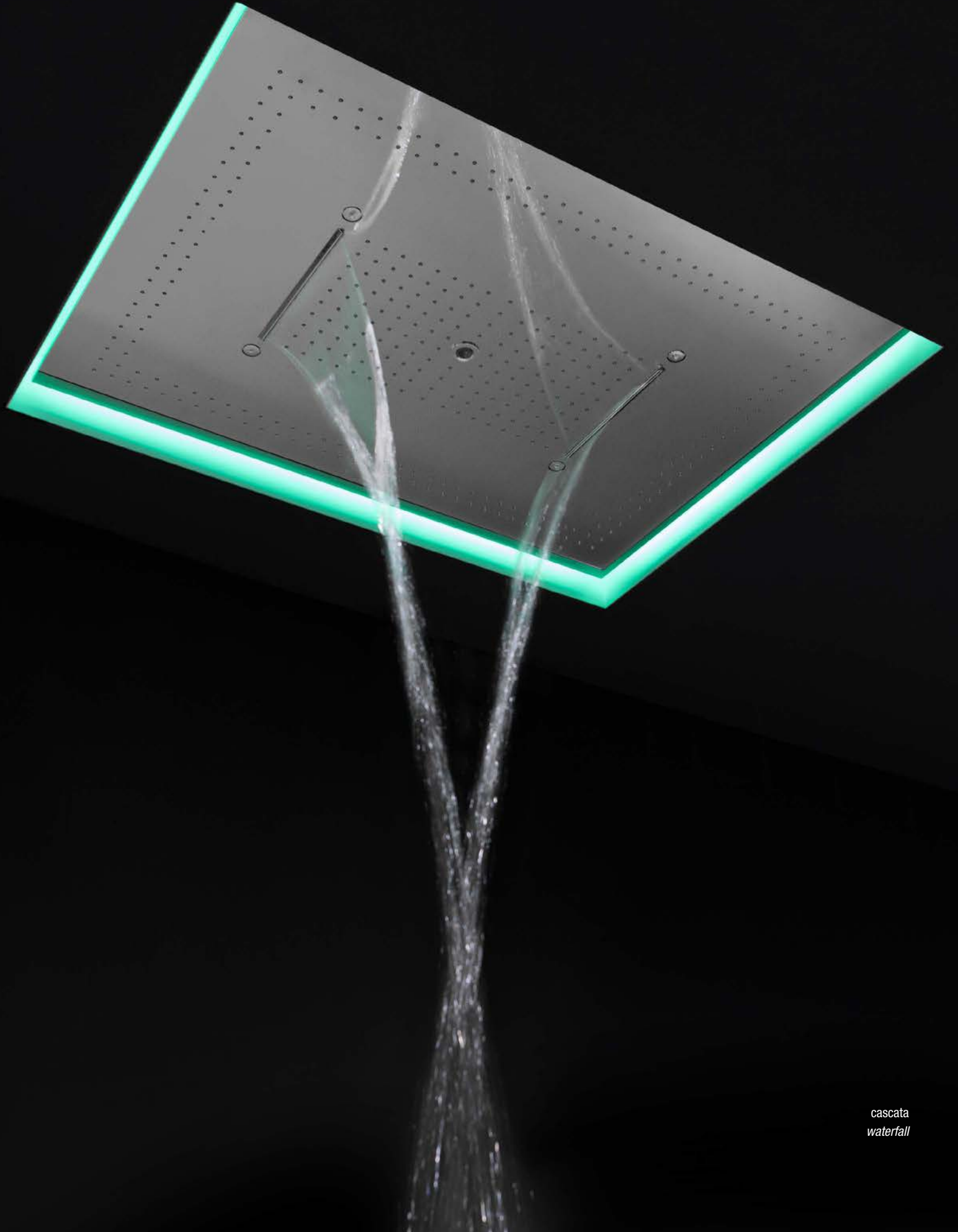

*cascata  
waterfall*



doccia perimetrale  
*perimeter shower*



doccia centrale  
*central shower*



chiodo  
*jet*



nebulizzatori  
*nebulizer*



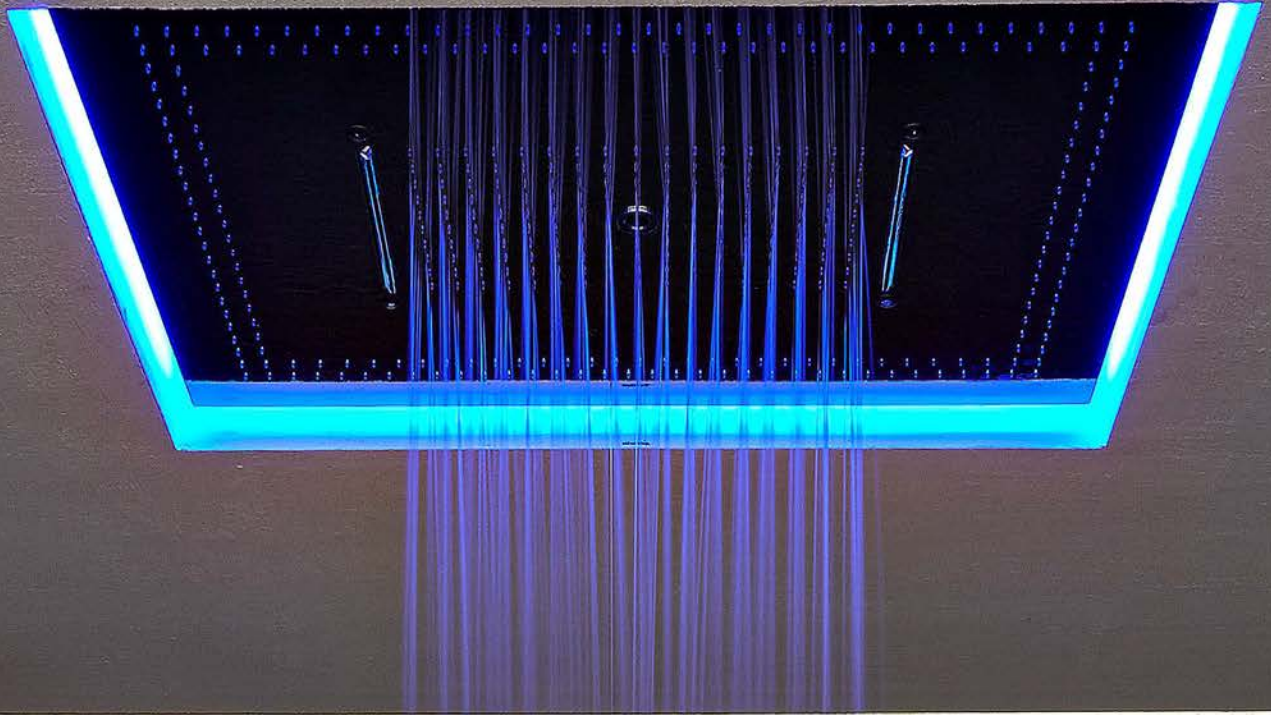

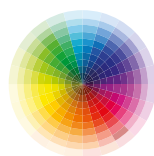
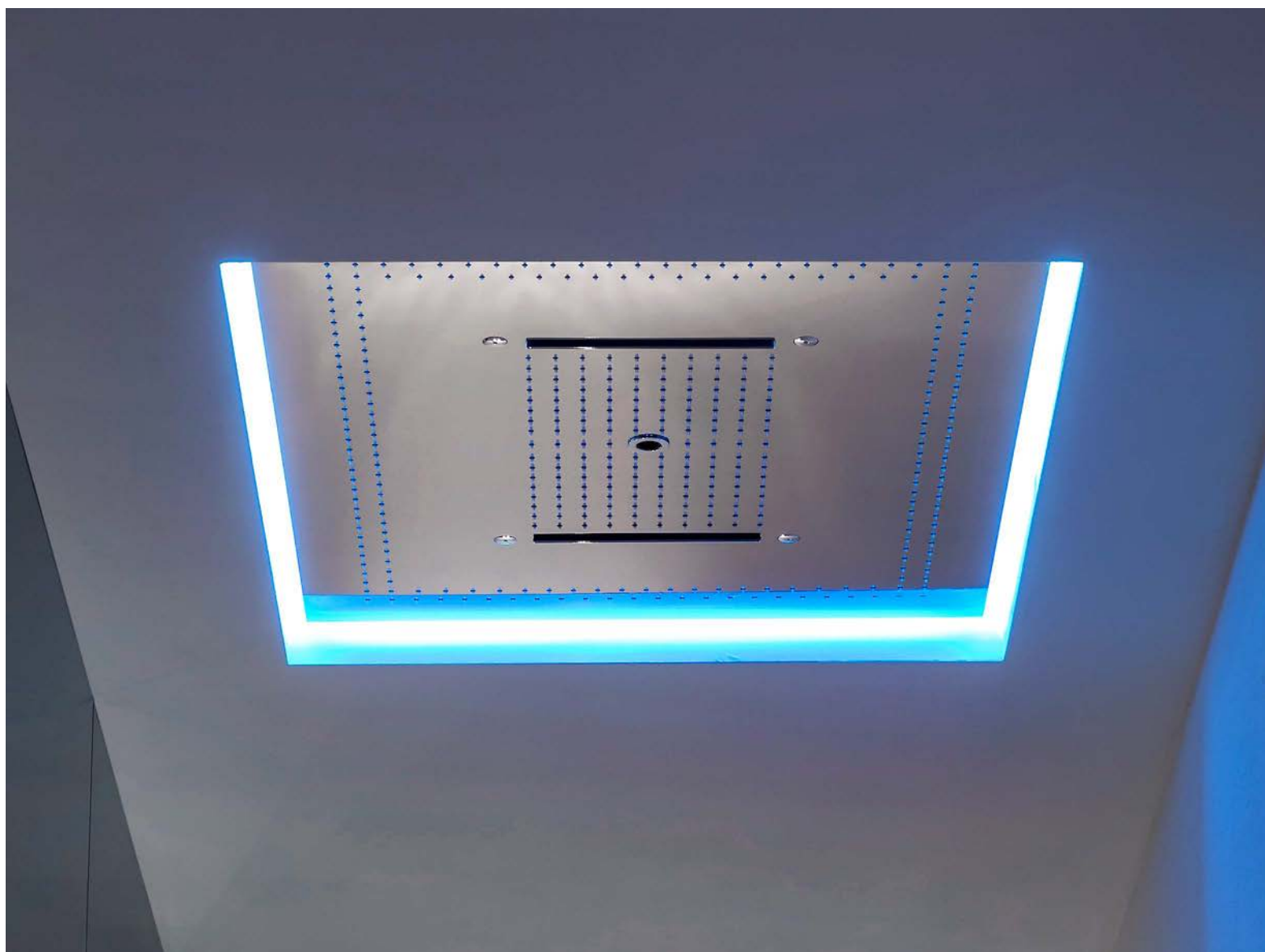

Tutti i soffioni con illuminazione a LED RGB sono dotati di telecomando waterproof IP66 che può essere utilizzato comodamente sotto la doccia.

*All overhead showers with RGB LED lighting come with an IP66 waterproof remote control that can easily be used under the shower.*



H	P	L	art.
11	75	100	METEOXXL

Soffione ad incasso a soffitto in acciaio AISI 304 con doccia centrale e perimetrale, doppia cascata, getto a chiodo, nebulizzatori e possibile illuminazione a LED RGB comprensiva di telecomando waterproof.

N.B. Necessita di deviatore a cinque vie.

*Ceiling encased showerhead in stainless steel AISI 304 with central and perimeter shower, double waterfall, hard center jet, nebulizers and possible LED RGB lighting complete with waterproof remote.*

*P.S. Requires five way diverter.*

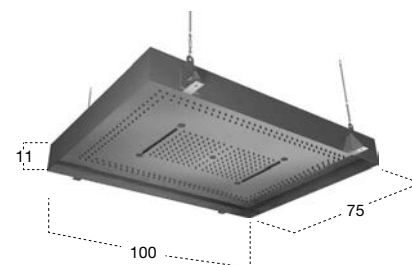

METE03C



doccia centrale  
*central shower*



cascata  
*waterfall*

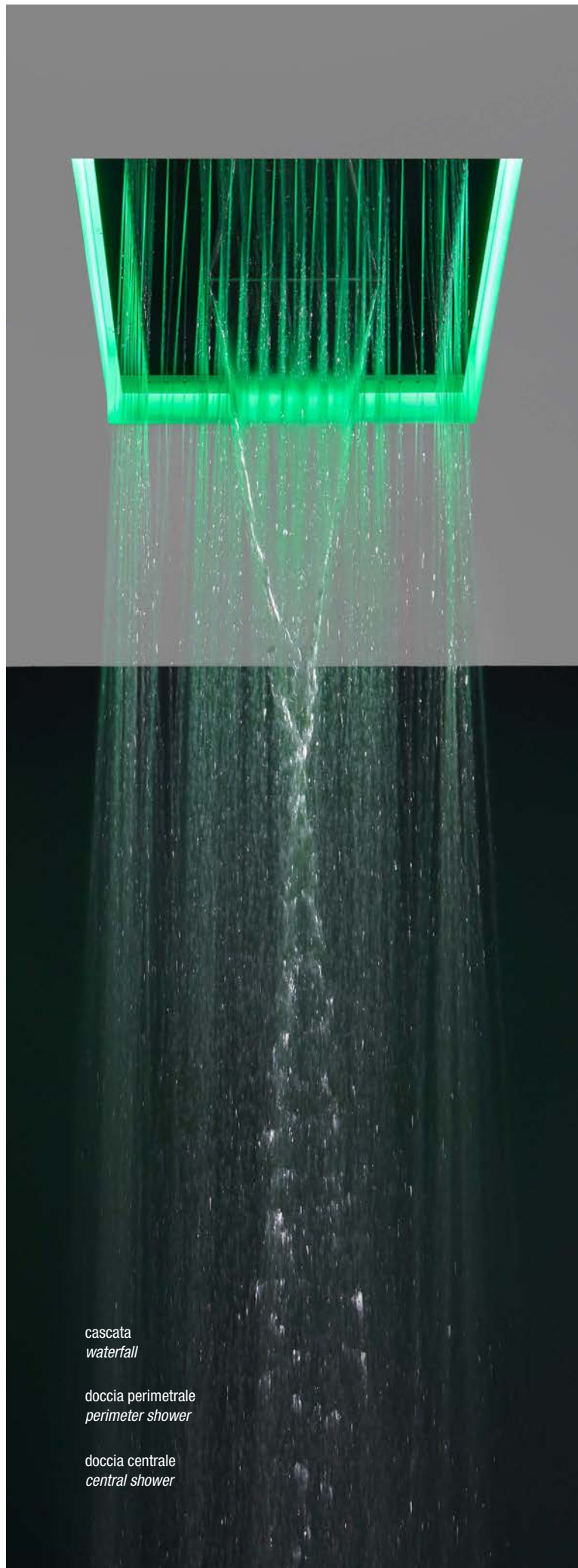

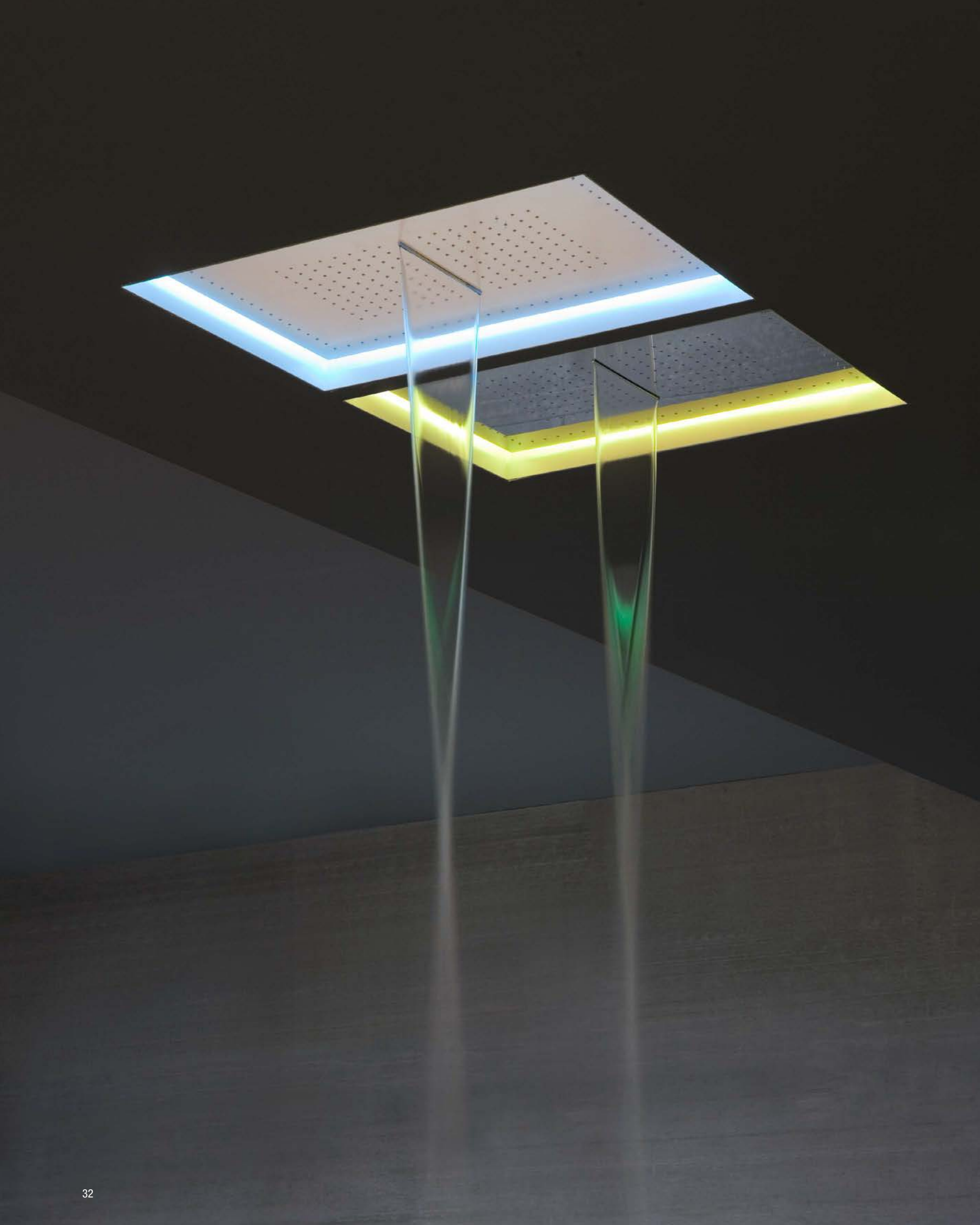

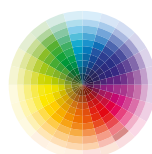

Tutti i soffioni con illuminazione a LED RGB sono dotati di telecomando waterproof IP66 che può essere utilizzato comodamente sotto la doccia.



All overhead showers with RGB LED lighting come with an IP66 waterproof remote control that can easily be used under the shower.

H	P	L	art.
11	52	75	METE03C

Soffione ad incasso a soffitto in acciaio AISI 304 con doccia centrale e perimetrale, cascata e possibile illuminazione a LED RGB comprensiva di telecomando waterproof.  
N.B. Necessita di deviatore a tre vie.

*Ceiling encased showerhead in stainless steel AISI 304 with central and perimeter shower, waterfall and possible RGB LED lighting and waterproof remote.  
P.S. Requires three way diverter.*

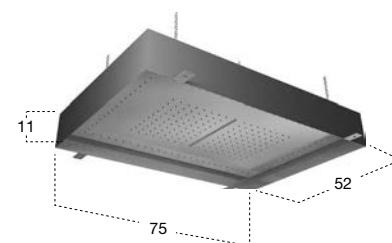

METEO

COME SE CI FOSSE UN ARCOBALENO  
*AS IF THERE WERE A RAINBOW*

Tonificante: colori caldi dal giallo al rosso fino al verde  
Rilassante: dal blu al verde neutrale  
Energizzante: rosso, giallo, seguiti dal verde e dal bianco

*Invigorating: warm colors from yellow to red up to green*  
*Relaxing: from blue to neutral green*  
*Energizing: red, yellow, followed by green and white*

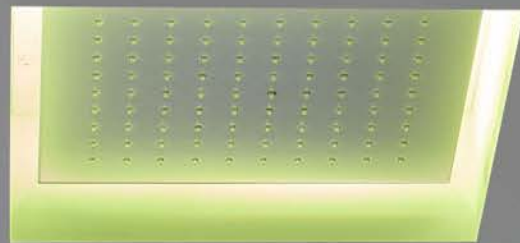
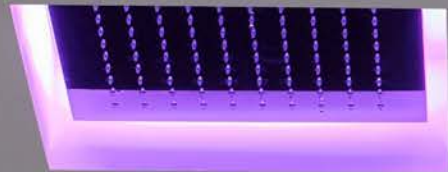
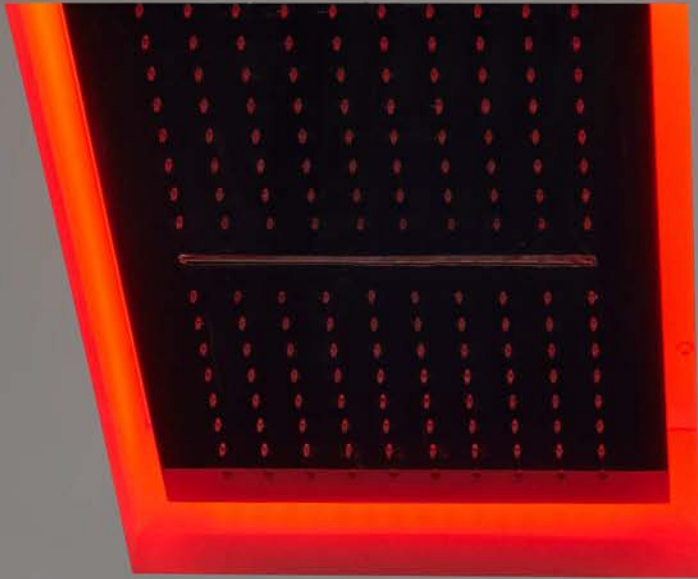





doccia centrale  
central shower

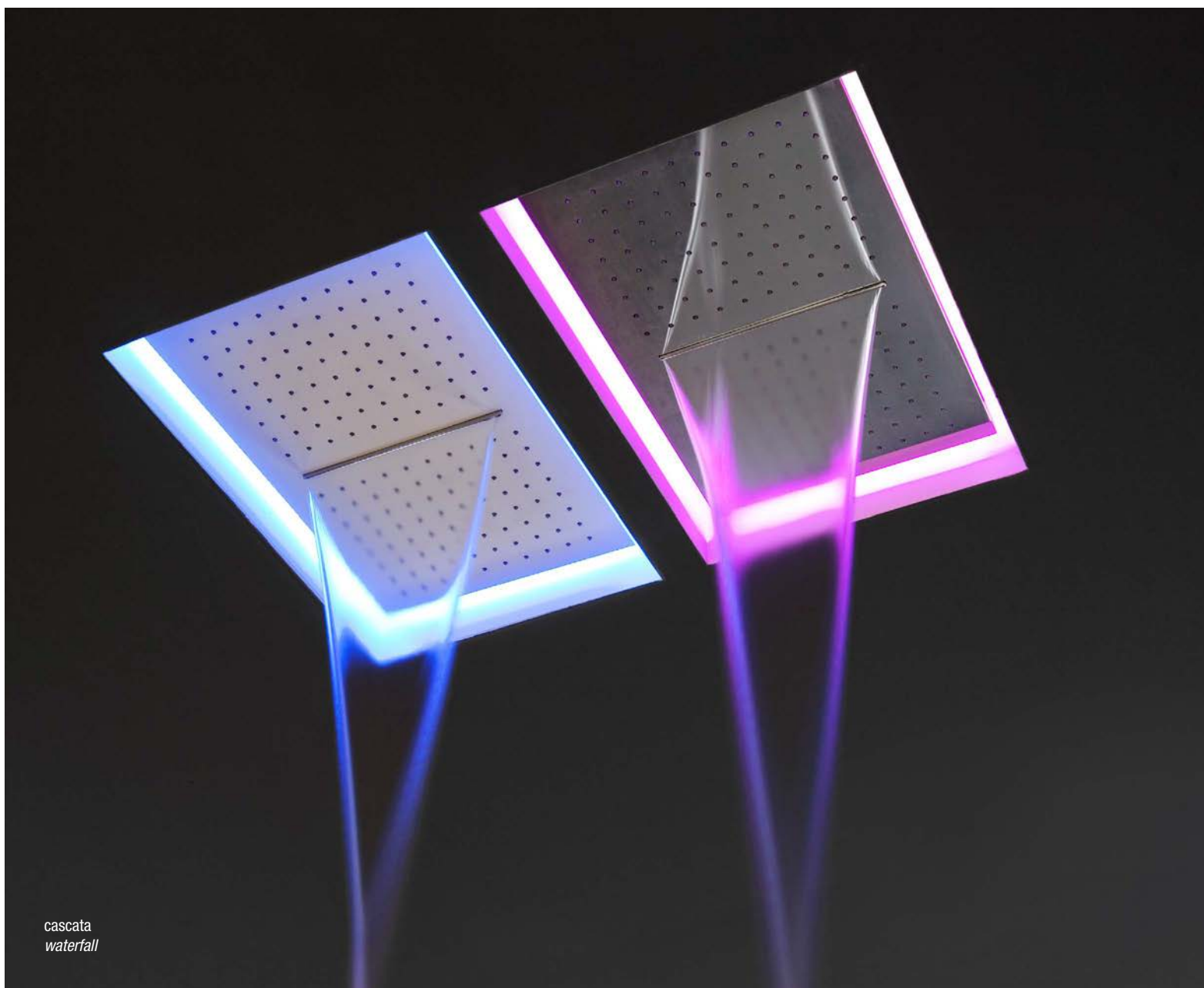

cascata  
waterfall

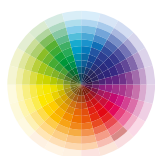

Tutti i soffioni con illuminazione a LED RGB sono dotati di telecomando waterproof IP66 che può essere utilizzato comodamente sotto la doccia.



All overhead showers with RGB LED lighting come with an IP66 waterproof remote control that can easily be used under the shower.

H	P	L	art.
11	35	52	METE02C

Soffione ad incasso a soffitto in acciaio AISI 304 con doccia centrale e cascata, disponibile in diverse finiture, con possibile illuminazione a LED RGB comprensiva di telecomando waterproof.

N.B. Necessita di deviatore a due vie.

*Ceiling encased showerhead in stainless steel AISI 304 with central shower and waterfall, available in various finishes, with possible RGB LED lighting and waterproof remote.  
P.S. Requires two way diverter.*

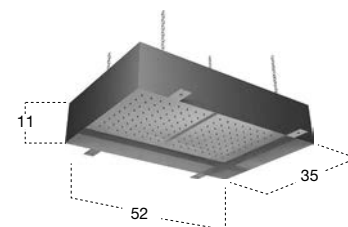

METE01

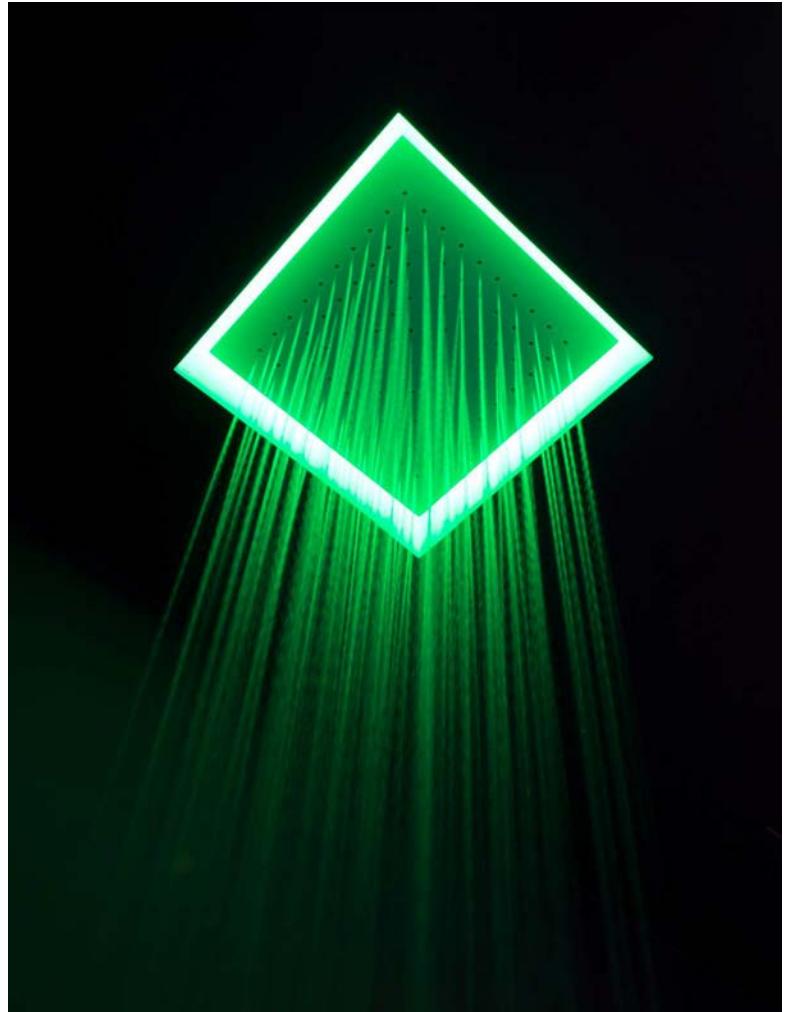
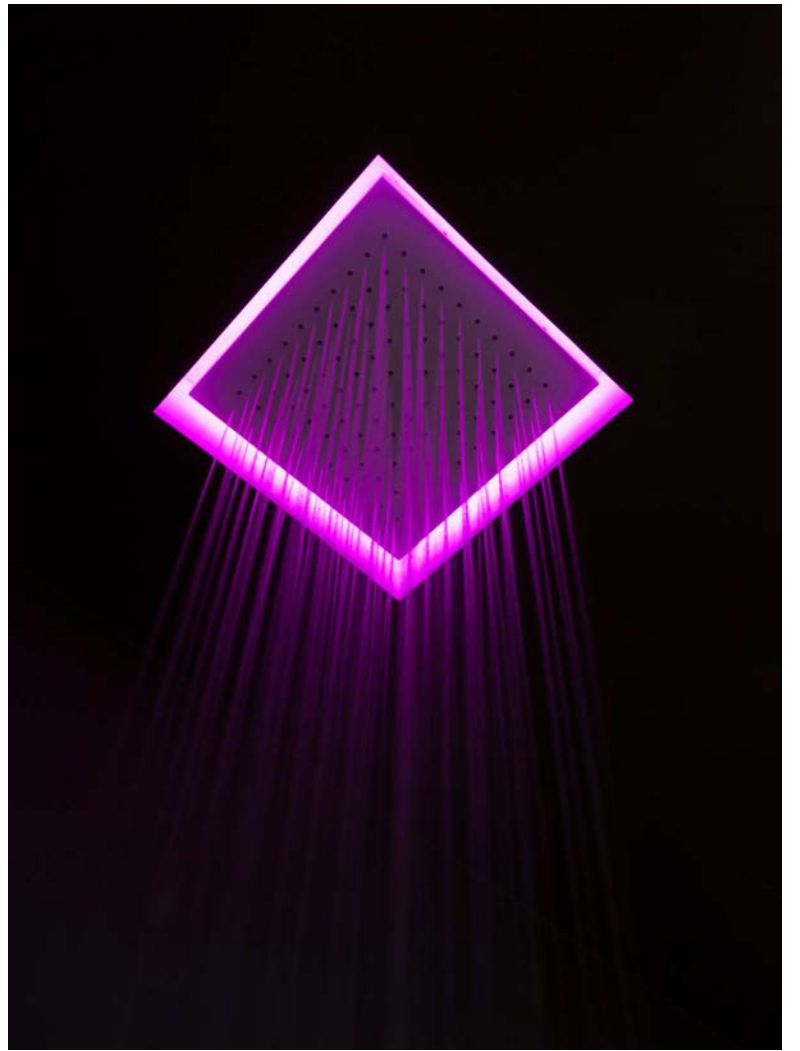
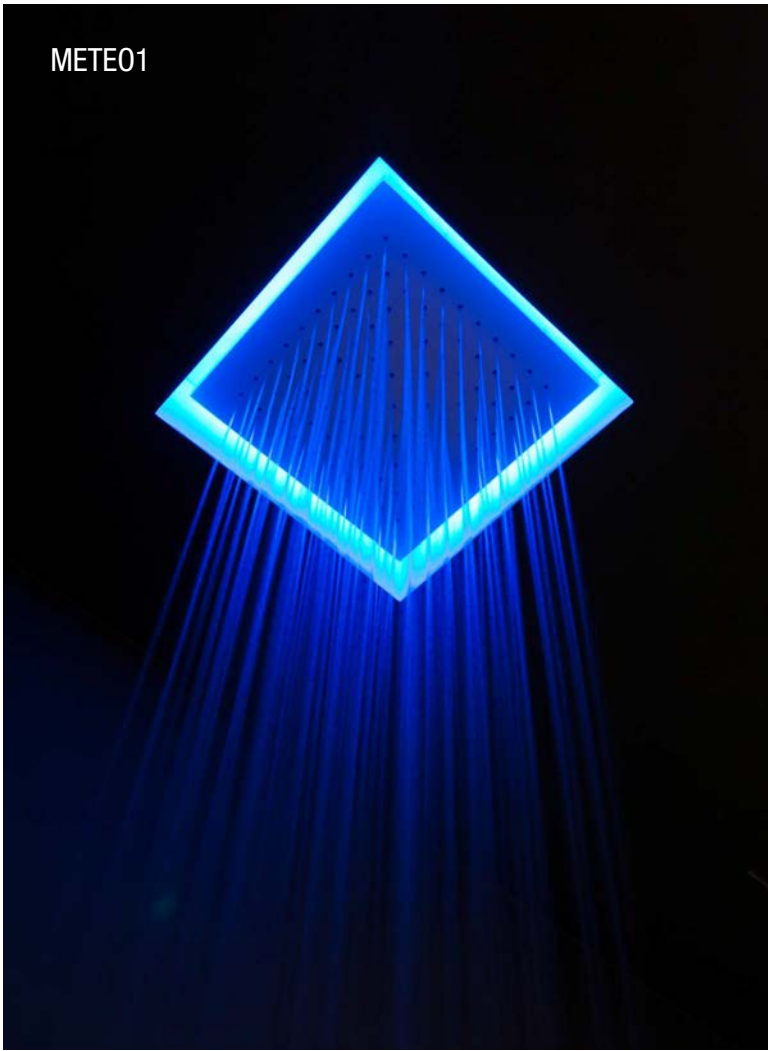

METE02

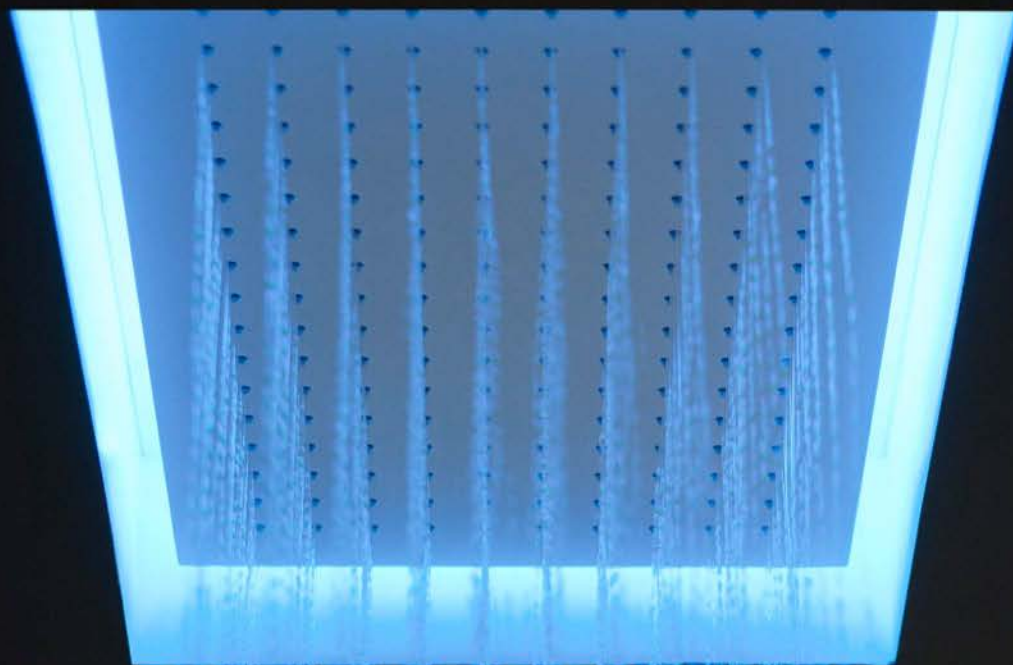

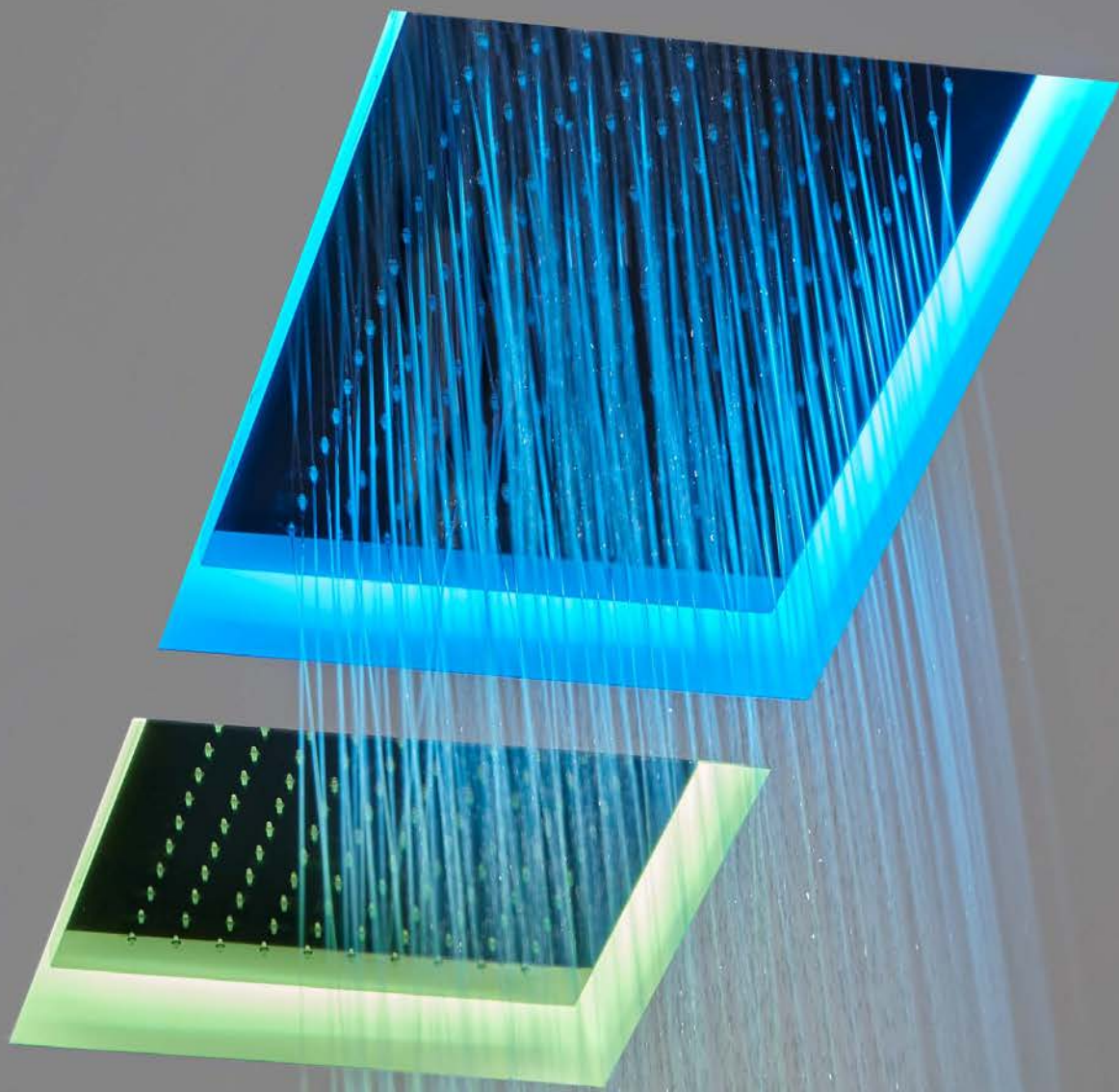

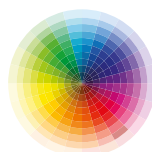
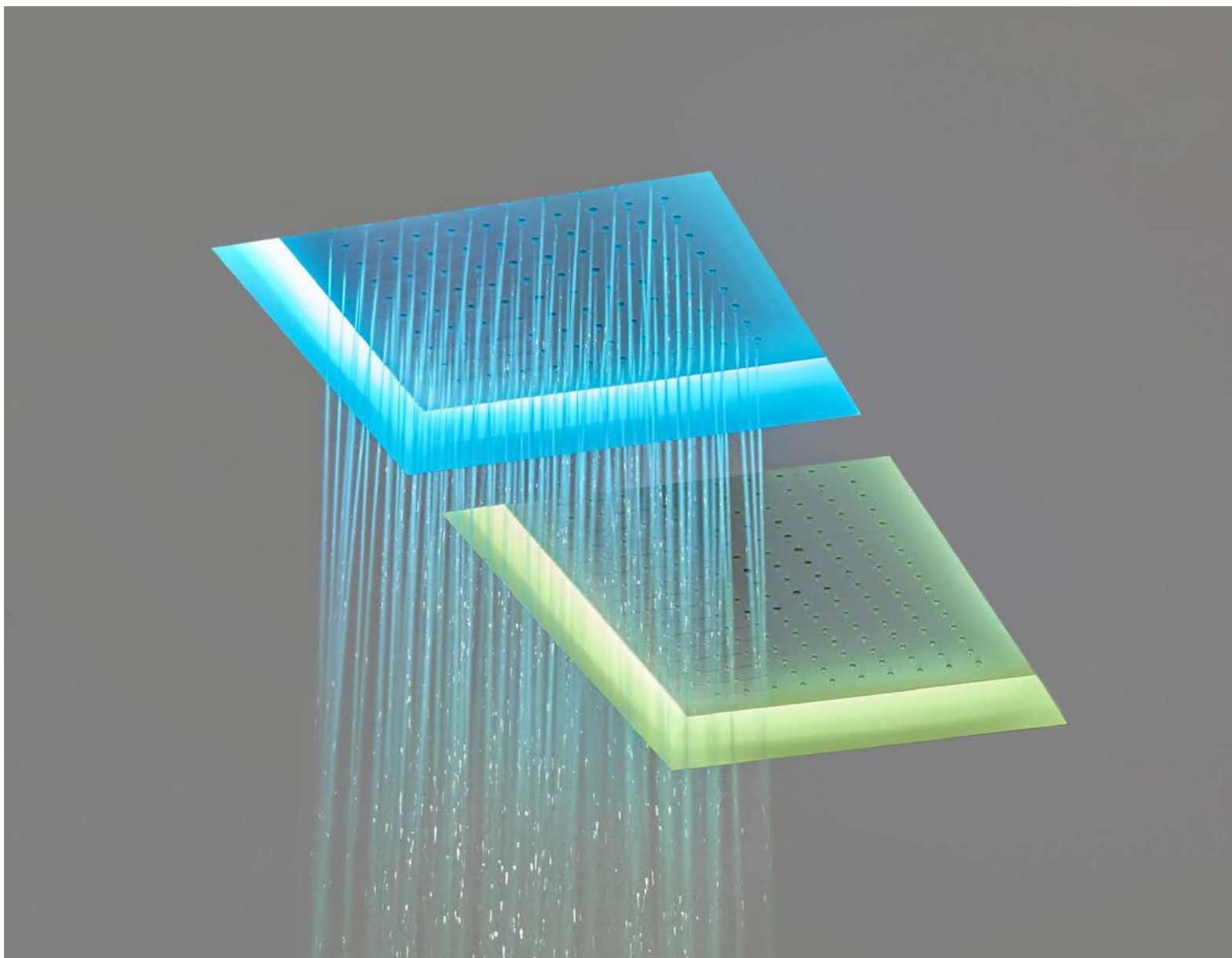

Tutti i soffioni con illuminazione a LED RGB sono dotati di telecomando waterproof IP66 che può essere utilizzato comodamente sotto la doccia.



*All overhead showers with RGB LED lighting come with an IP66 waterproof remote control that can easily be used under the shower.*

Art. METE01

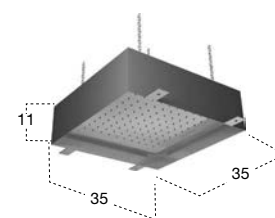

Art. METE02

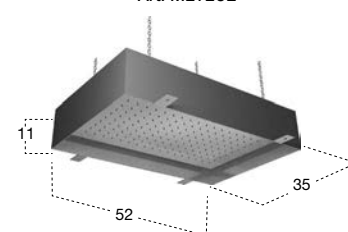

H	P	L	art.
11	35	35	METE01
11	35	52	METE02

Soffione ad incasso a soffitto in acciaio AISI 304, disponibile in diverse finiture, con possibile illuminazione a LED RGB comprensiva di telecomando waterproof.

*Ceiling encased showerhead in stainless steel AISI 304 available in various finishes, with possible RGB LED lighting and waterproof remote.*

METEO





11



12



13



14



15



16



17



18



19



20



# FUORIMETEO SLIM

\_2011

design  
Nevio  
Tellatin

Modello e design registrato, brevetto depositato  
*Registered model and design, patent filed*

Quando l'incasso non è possibile, c'è FUORIMETEO SLIM, soli 9 cm dal soffitto, bianco o verniciabile a contrasto o nello stesso colore delle pareti.

*When encasing is not possible consider FUORIMETEO SLIM, only 9 cm H, white or paintable in a contrasting or same color as the ceiling.*





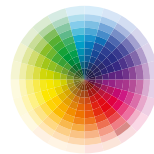

Tutti i soffioni con illuminazione a LED RGB sono dotati di telecomando waterproof IP66 che può essere utilizzato comodamente sotto la doccia.



*All overhead showers with RGB LED lighting come with an IP66 waterproof remote control that can easily be used under the shower.*

H	P	L	art.
9	35	35	FMS10

Soffione a soffitto con struttura esterna in acciaio AISI 304, disponibile in diverse finiture, con possibile illuminazione a LED RGB comprensiva di telecomando waterproof.

*Ceiling mounted showerhead with external frame in steel AISI 304 available in various finishes, with possible RGB LED lighting and waterproof remote.*

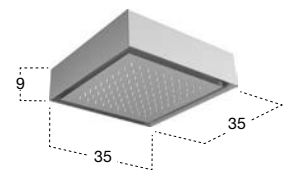

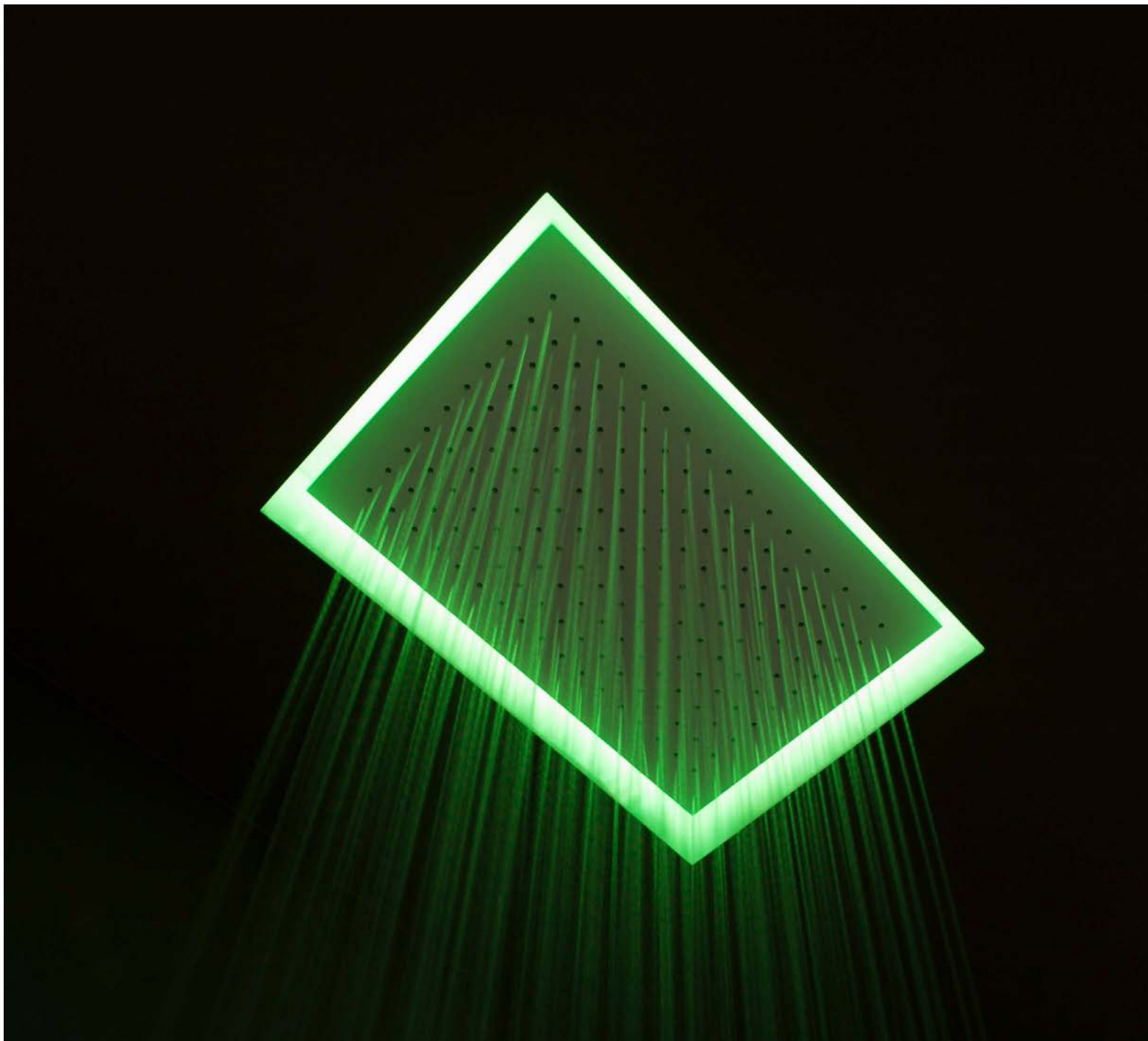

Tutti i soffioni con illuminazione a LED RGB sono dotati di telecomando waterproof IP66 che può essere utilizzato comodamente sotto la doccia.

*All overhead showers with RGB LED lighting come with an IP66 waterproof remote control that can easily be used under the shower.*

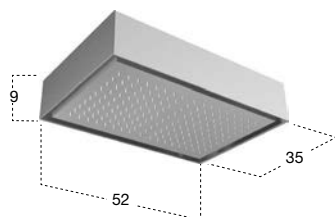
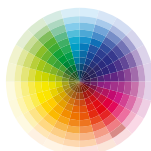

H	P	L	art.
9	35	52	FMS20

Soffione a soffitto con struttura esterna in acciaio AISI 304, disponibile in diverse finiture, con possibile illuminazione a LED RGB comprensiva di telecomando waterproof.

*Ceiling mounted showerhead with external frame in steel AISI 304 available in various finishes, with possible RGB LED lighting and waterproof remote.*

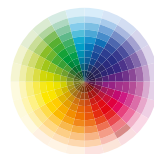
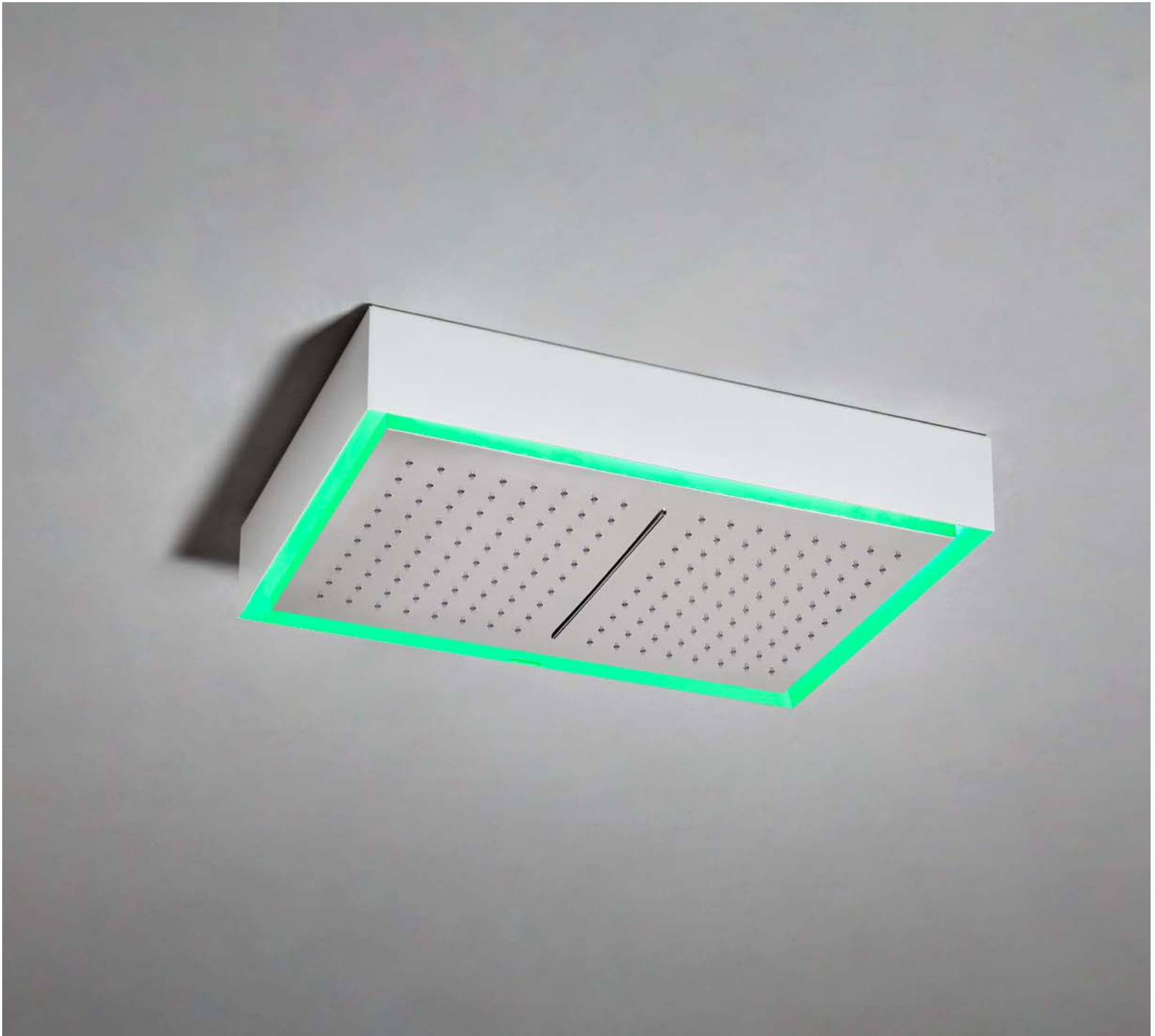

Tutti i soffioni con illuminazione a LED RGB sono dotati di telecomando waterproof IP66 che può essere utilizzato comodamente sotto la doccia.



All overhead showers with RGB LED lighting come with an IP66 waterproof remote control that can easily be used under the shower.

H	P	L	art.
9	35	52	FMS20C

Soffione a soffitto con doccia centrale, cascata e struttura esterna in acciaio AISI 304, disponibile in diverse finiture, con possibile illuminazione a LED RGB comprensiva di telecomando waterproof.

N.B. Necessita di deviatore a due vie.

*Ceiling mounted showerhead with central shower, waterfall and external frame in steel AISI 304, available in various finishes, with possible RGB LED lighting and waterproof remote. P.S. Requires two way diverter.*

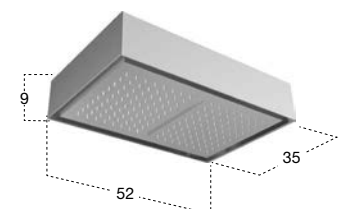

# LAMATTONELLA

\_2014

design  
Nevio  
Tellatin

UN MODULO QUADRATO IN ACCIAIO INOX LUCIDO  
*A SQUARE MODULE IN POLISHED STAINLESS STEEL*

Semplicemente con una nicchia nel cartongesso si può ottenere un binario che ospita gli elementi desiderati: la cascata, la pioggia, la pioggia con il chiodo, nella sequenza voluta, in modo da creare uno straordinario unico soffione.

*With a simple niche in the plasterboard you can obtain a track to house the desired elements: waterfall, rainfall, rainfall with nail jet, in the desired sequence so as to create an extraordinary and unique showerhead.*





## LAMATTONELLA

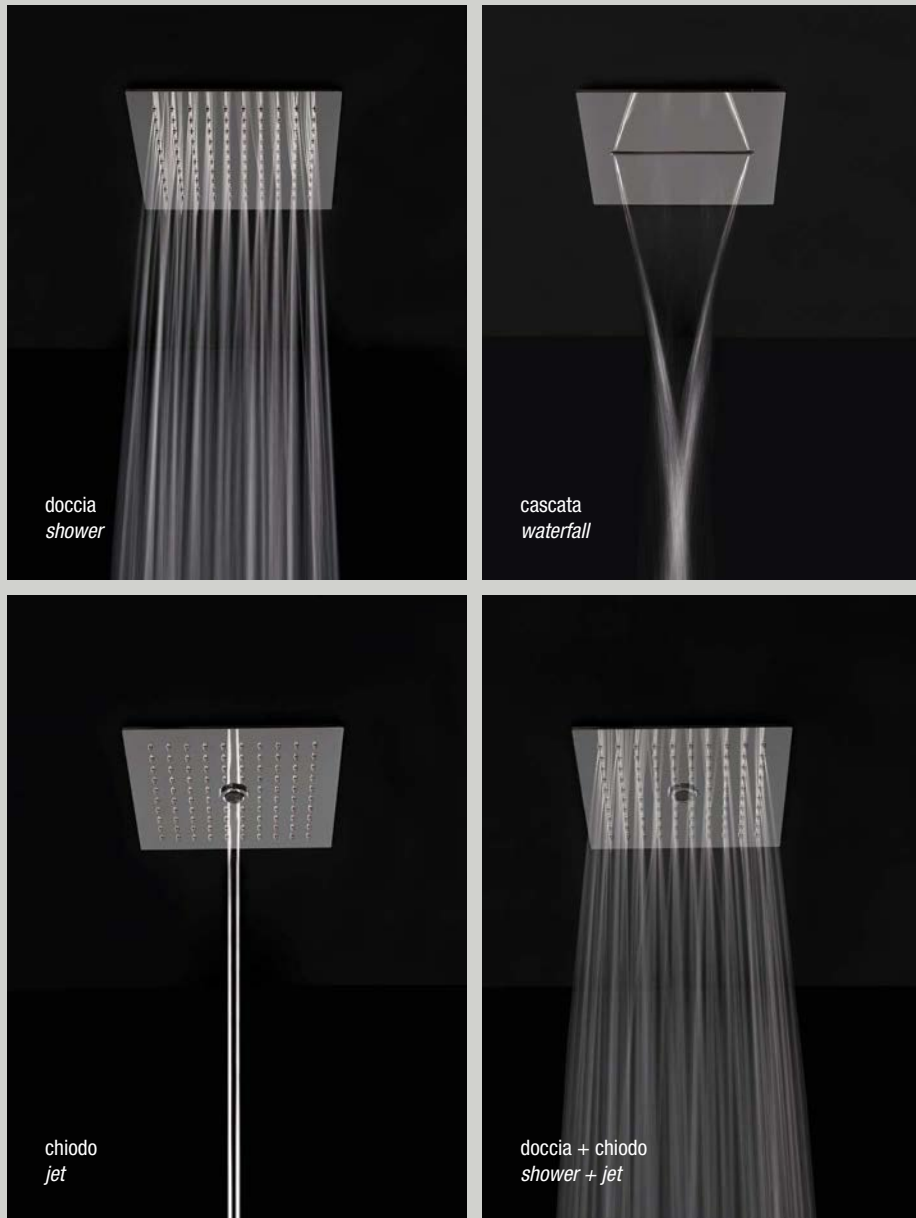

Un modulo quadrato: LAMATTONELLA appunto. Realizzato in acciaio inox lucido, ciascun soffione, in grado di erogare acqua con effetto pioggia o attraverso un getto a cascata, viene accostato liberamente agli altri, assolutamente identici per forma e dimensione. Integrati al soffitto i moduli, dallo spessore molto contenuto, vengono posizionati liberamente generando una griglia personalizzata, dando vita a una superficie piastrellata dalla quale l'acqua fuoriesce in maniera molto più naturale, alternando getti e posizioni. Un sistema elegante e funzionale, che si avvale di un particolare aggancio alla base fissata al soffitto che ne facilita l'installazione e la rimozione.

*A completely new concept, a project that allows you to break down the individual functions of the showerhead allowing to create new wellness paths. A square module: LAMATTONELLA. Made of polished stainless steel, each showerhead with a single function, rainfall, cascade or single jet that can be placed side by side because identical in shape and size. Integrated in the ceiling with a minimal thickness can be positioned freely creating a tiled surface effect from which water flows. An elegant and functional system which makes use of a particular coupling system to the base and fixed to the ceiling facilitating installation removal.*



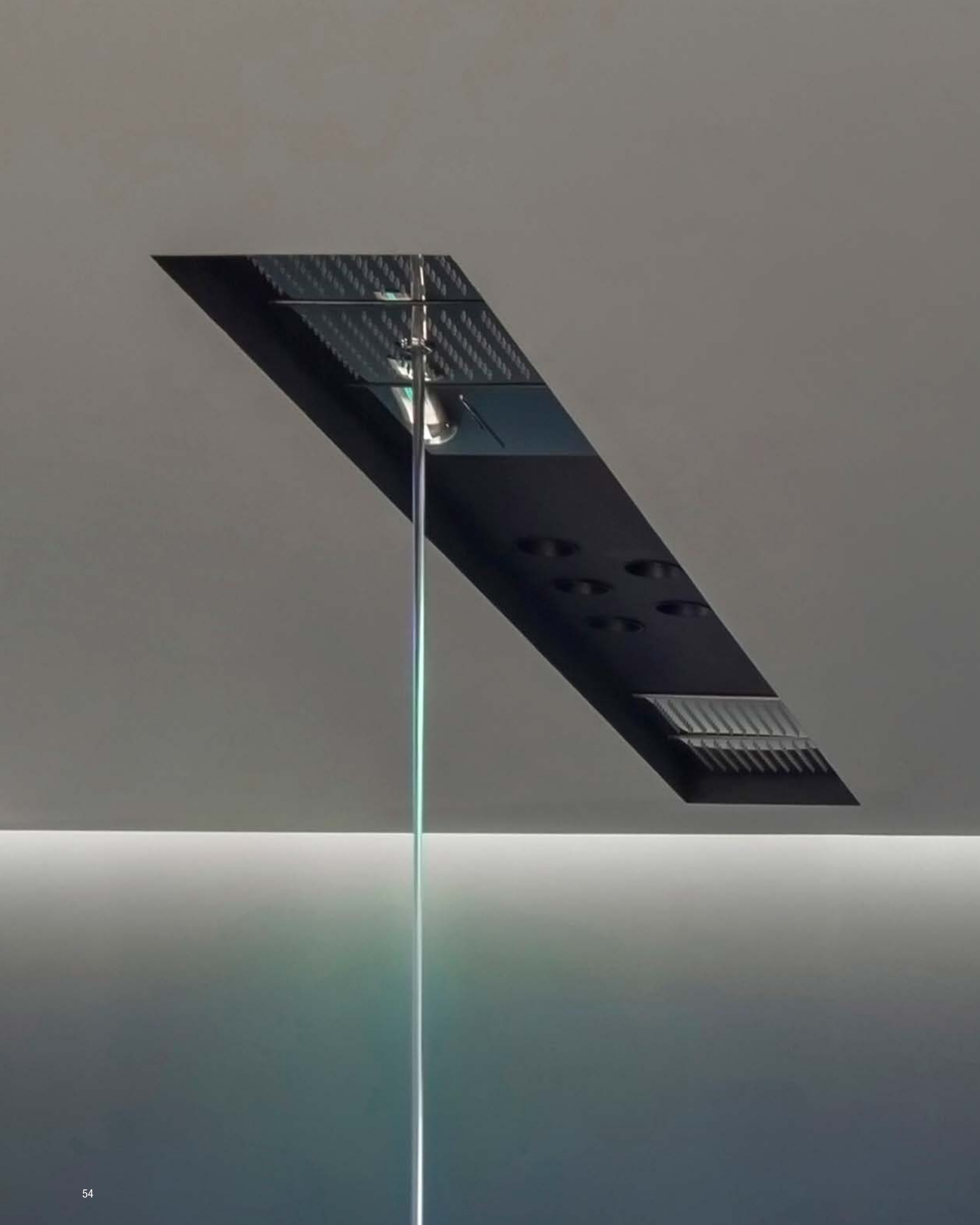



H	P	L	art.
0,5	25	25	LMN1_A
0,5	25	25	LMN2_A
0,5	25	25	LMN3_A

**Art. LMN1\_A**

Soffione modulare ad incasso a soffitto in acciaio inox lucido AISI 304.

*Ceiling encased modular showerhead in polished stainless steel AISI 304.*

**Art. LMN2\_A**

Soffione modulare ad incasso a soffitto con getto a chiodo in acciaio inox lucido AISI 304.

N.B. Necessita di deviatore a due vie.

*Ceiling encased modular showerhead with hard center jet in polished stainless steel AISI 304.*

*P.S. Requires two way diverter.*

**Art. LMN3\_A**

Soffione modulare ad incasso a soffitto con cascata in acciaio inox lucido AISI 304.

*Ceiling encased modular showerhead with waterfall in polished stainless steel AISI 304.*

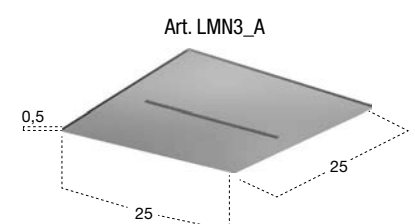
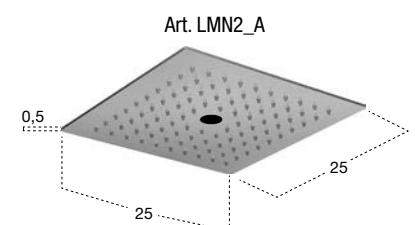
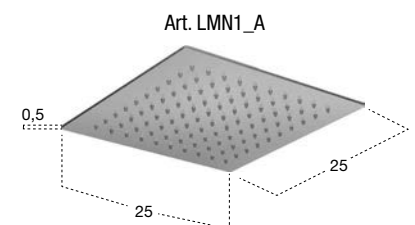

# ZENIT

\_2018

design  
AL Studio

Una fonte che scompare nel soffitto annullandosi. Ruota attorno al tema dell'assenza il progetto ZENIT10, il soffione che si nasconde per lasciare all'acqua il ruolo di assoluta protagonista. Le dimensioni contenute determinano un getto concentrato e intenso, l'assenza di elementi visibili facilita l'inserimento in qualsiasi contesto di stile. Perfetto per inserirsi in ambienti minimali e contemporanei, ZENIT10 si manifesta unicamente quando è in funzione, generando una sorgente di benessere apparentemente nascosta.

Privo di telaio visibile il soffione appare come un semplice foro nel controsoffitto e rimanda in maniera esplicita all'immagine di altri elementi, proponendo un radicale cambio di significato e di funzione. L'origine di ZENIT10 è infatti quella di un corpo illuminante da incasso pensato appositamente per il bagno, con la possibilità di essere collocato anche all'interno dello spazio doccia grazie alle specifiche caratteristiche tecniche. Partendo quindi dalla stessa struttura di incasso è bastato sostituire il faretto con il soffione per dare vita a uno strumento di benessere in pochissimo spazio.

*A source that disappears in the ceiling. The ZENIT10 project revolves around the theme of absence, the overhead shower hides to leave the role of absolute protagonist to water. The small dimensions determine a concentrated and intense jet, the absence of visible elements facilitates the insertion in any context or style. Perfect to fit in minimal and contemporary settings, ZENIT10 manifests itself only when it is operating, generating a source of hidden well-being.*

*Without a visible frame, the overhead shower appears as a simple hole in the false ceiling and refers explicitly to the image of other elements, proposing a radical change in meaning and function. The origin of ZENIT10 is in fact that of a recessed lighting fixture designed specifically for the bathroom, with the possibility of being placed inside the shower space thanks to the specific technical characteristics. Starting from the same recessed structure it was enough to replace the spotlight with the showerhead to give life to a tool of well-being in very little space.*







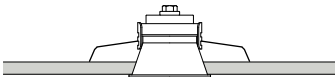

	H	Ø	art.
	6	8	ZENIT10
	6	8	ZENIT11
	10	8	ZENITLED

**Art. ZENIT10**

Soffione in Delrin nero con struttura ad incasso a soffitto in alluminio nero.

*Black Delrin shower with ceiling encasing structure in black aluminum.*

**Art. ZENIT11**

Soffione in Delrin nero con struttura ad incasso a soffitto in alluminio nero con getto a chiodo.

*Black Delrin shower with ceiling encasing structure in black aluminum and nail jet.*

**Art. ZENITLED**

Lampada con struttura ad incasso a soffitto in alluminio nero e illuminazione a led.

*Lamp with ceiling encasing structure in black aluminum and led lighting.*

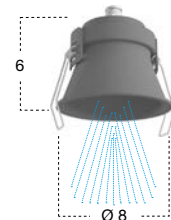
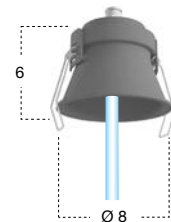
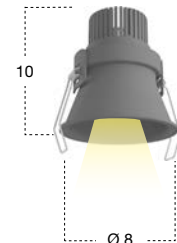
**Art. ZENIT10****Art. ZENIT11****Art. ZENITLED**



# LUMEN

\_2017

design  
Marco  
Pisati

Acqua e colore  
*Water and color*

Un sole che illumina  
*A sun that shines*

Acqua e colore, benessere e relax per il corpo e per la mente. Un sole che illumina, una luce che attrae e cattura lo sguardo, un satellite che orbita nello spazio. Lumen è il soffione caratterizzato da un nucleo centrale colorato attorno al quale si dispongono gli ugelli ospitati da una calotta emisferica dal quale esce un getto speciale nella quale l'acqua converge verso il centro, come attirata da un "campo magnetico" ma in realtà direzionata dall'orientamento del getto.

Il relax garantito da Lumen combina il benessere dell'acqua agli effetti della cromoterapia, l'immagine del soffione in funzione caratterizza l'ambiente bagno donandogli una sofisticata eleganza e un'aura di magia. Acceso diventa il fulcro dello spazio, spento, scompare alla vista. La sua perfetta geometria disegna un anello sottile, un cerchio nel soffitto all'interno del quale pulsa un cuore di luce.

*Water and color, well-being and relaxation for body and mind. A sun that shines, a light that attracts and catches the eye, a satellite that orbits in space. Lumen is the overhead shower characterized by a colored central nucleus around which nozzles are arranged. All hosted by a hemispherical shell from which a special jet of water converges towards the center, as if attracted by a "magnetic field" but actually directed from the orientation of the jet.*

*Lumen guarantees a certain relaxation by combining water with the effects of chromo-therapy. The image of the overhead shower in function gives the bathroom a sophisticated elegance and an aura of magic. When lit, it becomes the fulcrum of space, when off, disappears from sight. It's perfect geometry draws a thin ring, a circle in the ceiling in which a heart of light pulsates.*





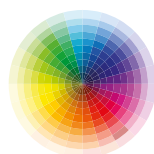
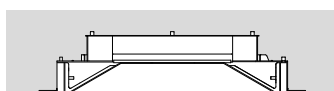

Tutti i soffioni con illuminazione a LED RGB sono dotati di telecomando waterproof IP66 che può essere utilizzato comodamente sotto la doccia.



*All overhead showers with RGB LED lighting come with an IP66 waterproof remote control that can easily be used under the shower.*

H	P	L	art.
12	54	54	LUMEN

Struttura ad incasso a soffitto in acciaio AISI 304 verniciato bianco con illuminazione a LED RGB comprensivo di telecomando waterproof.

*Ceiling encased structure in AISI 304 lacquered white with LED RGB lighting complete with waterproof remote control.*

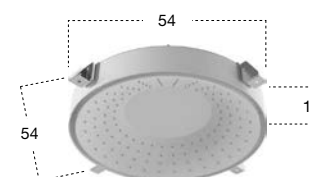

# METEO\_OUT / METEO\_IN

\_2014

design  
Nevio  
Tellatin

Modello e design registrato, brevetto depositato  
*Registered model and design, patent filed*



## METEO\_OUT

Un volume morbido e organico, dall'immagine naturale, un "cratere buono" dal quale fuoriesce un'esplosione di benessere, uno spazio scavato dalla perfetta geometria circolare che si integra perfettamente nel soffitto e senza soluzione di continuità si apre nella superficie per sprigionare il massimo relax: Meteo\_Out è un nuovo soffione che associa alla forza primordiale dell'acqua, i benefici effetti della cromoterapia. Un anello di luce evidenzia infatti la profondità, definisce il luogo da cui fuoriesce l'acqua impreziosendo la superficie e i riflessi metallici del soffione in acciaio inox. Meteo\_Out completa una gamma di soffioni caratterizzati dalla forte componente emozionale che si associa a una tecnologia innovativa. L'illuminazione a LED RGB può essere gestita con telecomando waterproof per dare vita a scenari e sequenze personalizzate, grazie alle quali concepire un benessere su misura.

*A soft, organic volume, natural in shape from which comes out an explosion of wellness, a space carved out from the perfect circular geometry that integrates seamlessly into the ceiling and seamlessly opens the surface to unleash maximum relaxation: Meteo\_Out is a new showerhead that combines the power of water with the beneficial effects of color therapy. A ring of light shows depth and defines from where the water flows out embellishing the surface and the metallic sheen of the showerhead in stainless steel. Meteo\_Out is a complete range of showerheads characterized by a strong emotional component that is associated with innovative technology. The LED RGB lighting can be controlled with the waterproof remote control to create different scenarios as well as customized sequences through which to conceive health made to measure.*



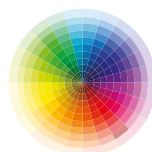
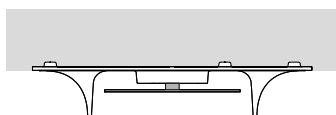

Tutti i soffioni con illuminazione a LED RGB sono dotati di telecomando waterproof IP66 che può essere utilizzato comodamente sotto la doccia.

*All overhead showers with RGB LED lighting come with an IP66 waterproof remote control that can easily be used under the shower.*



H	P	L	art.	art.
10	62	62	METEO_OUT	METEO_OUTL Con illuminazione a led / With led lighting

Struttura ad incasso a soffitto in Flumood con soffione in acciaio inox satinato AISI 304, con possibilità di illuminazione a LED RGB comprensiva di telecomando waterproof.

*Ceiling encased Flumood frame with satin stainless steel AISI 304 showerhead with possible LED RGB lighting complete with waterproof remote control.*

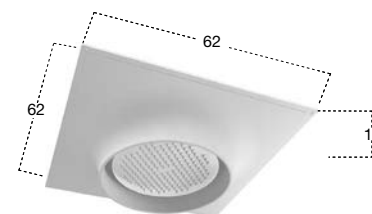



## METEO\_IN

Un satellite in orbita, un corpo celeste circondato da uno sciame di piccoli astri, un disco artificiale che nasconde una pioggia di acqua e luce. L'ultima evoluzione della collezione di soffioni Meteo indaga il tema del mistero, della sorpresa, della capacità della tecnologia di scomparire per lasciare spazio all'emozione. Un disco circolare, perfettamente integrato nel soffitto e avvolto da un anello di luce. Questa è l'immagine del soffione, è la schematizzazione estrema di un concetto, quello dell'integrazione della sorgente nello spazio. L'acqua cade direttamente dal soffitto, la luce colorata ne delimita la proiezione generando un fascio di infinite vibrazioni e riflessi cromatici. La sensazione di benessere è totale e coinvolge tutti i sensi.

*A satellite into orbit, a celestial body surrounded by a swarm of small stars, an artificial disc that hides a shower of water and light. The latest evolution of Meteo shower heads explores the theme of mystery, the surprise of technological skills to disappear and leave space to emotion. A circular disc, perfectly integrated in the ceiling and wrapped by a ring of light. The image of the showerhead, is the integration of the source in space. The water falls directly from the ceiling, colored light delimits the projection generating a beam of infinite vibrations and chromatic reflections. The feeling of wellness is complete, and involves all the senses.*



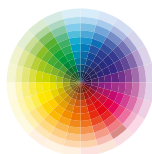
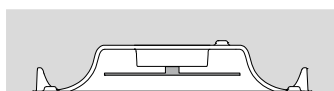

Tutti i soffioni con illuminazione a LED RGB sono dotati di telecomando waterproof IP66 che può essere utilizzato comodamente sotto la doccia.



All overhead showers with RGB LED lighting come with an IP66 waterproof remote control that can easily be used under the shower.

H	P	L	art.	art.
11	62	62	METEO_IN	METEO_INL Con illuminazione a led / With led lighting

Struttura ad incasso a soffitto in Flumood con soffione in acciaio inox satinato AISI 304, con possibilità di illuminazione a LED RGB comprensiva di telecomando waterproof.

*Ceiling encased Flumood frame with satin stainless steel AISI 304 showerhead with possible LED RGB lighting complete with waterproof remote control.*

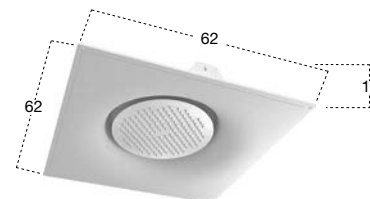



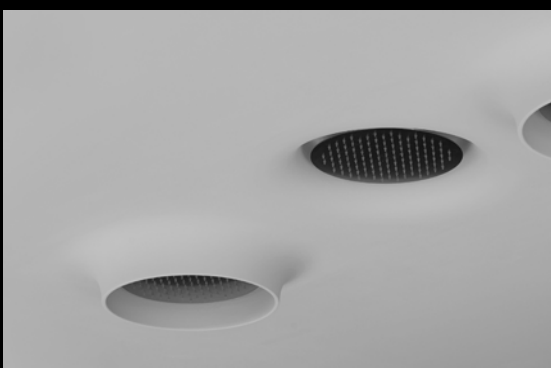

# VELA

\_2015

design  
AL Studio





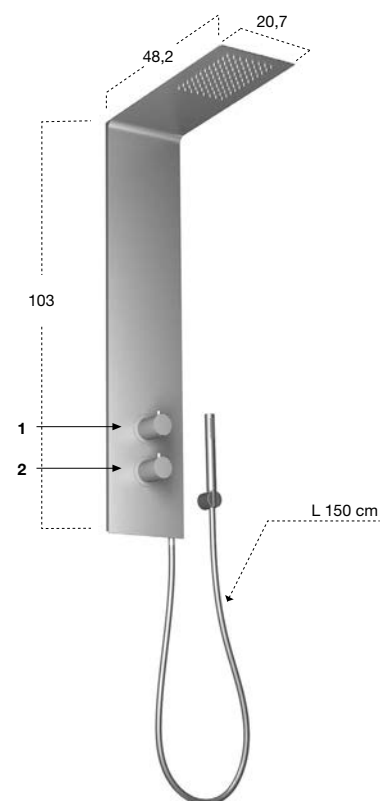
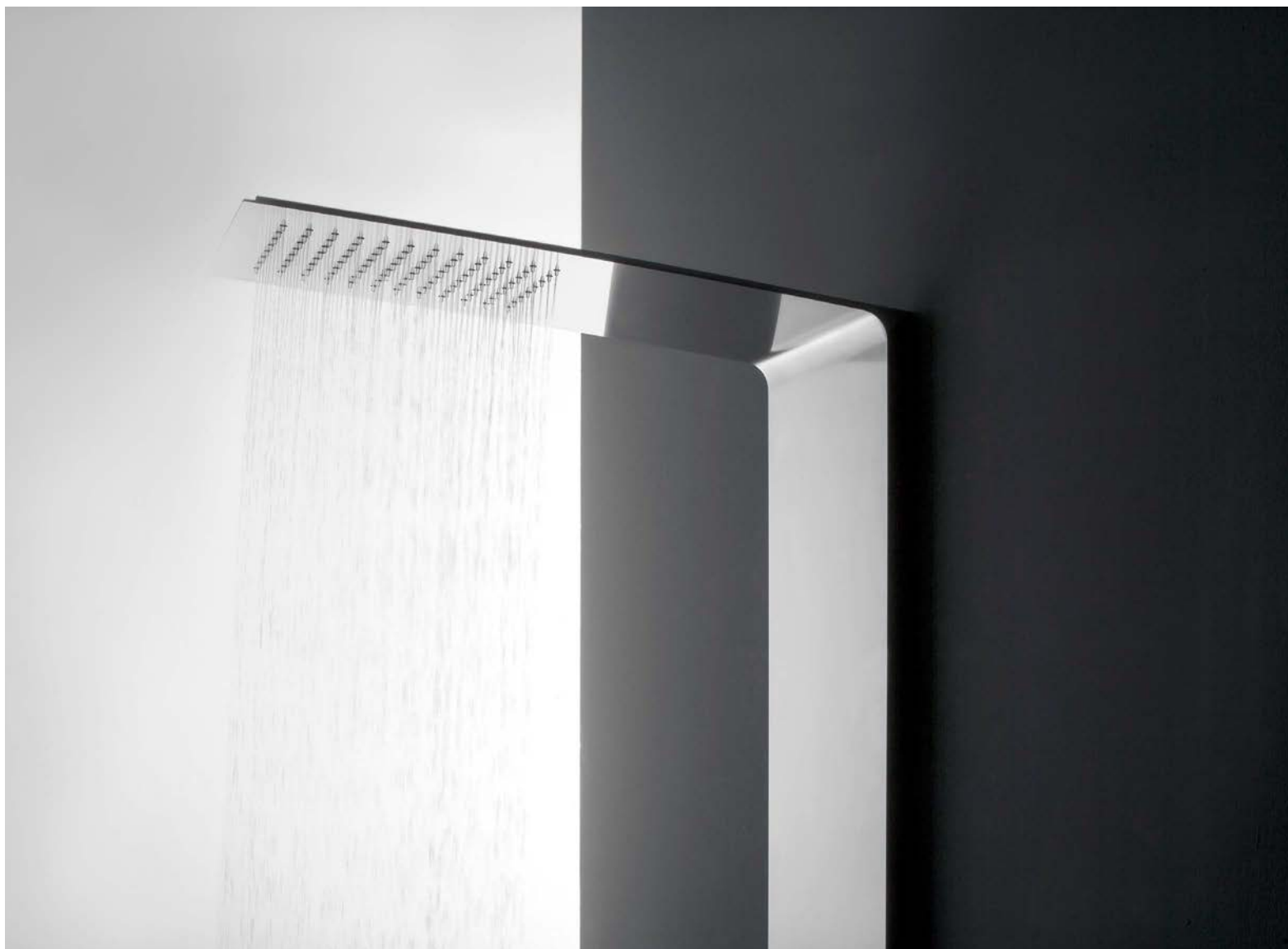

H	P	L	art.
103	48,2	20,7	VELA

Colonna doccia a parete in acciaio inox satinato AISI 304, completa di soffione, miscelatore termostatico (2), rubinetto di comando con deviatore a due vie (1) e doccetta con flessibile 150 cm.

*Showerhead column in AISI 304 satin stainless steel complete with thermostatic mixer (2), command handle with 2-way diverter (1) and hand shower with hose 150 cm.*





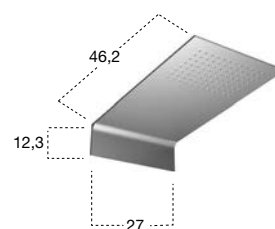

H	P	L	art.
12,3	46,2	27	MEZZAVELA

Soffione a parete in acciaio inox satinato AISI 304.

*AISI 304 satin stainless steel wall mounted showerhead.*





H	P	L	art.	
0,2	50,3	20,7	LASTRA	Acciaio Satinato / <i>Satin Stainless Steel</i>
0,2	50,3	20,7	LASTRALU	Acciaio Lucido / <i>Polished Stainless Steel</i>
0,2	50,3	20,7	BILASTRA	Acciaio Satinato / <i>Satin Stainless Steel</i>
0,2	50,3	20,7	BILASTRALU	Acciaio Lucido / <i>Polished Stainless Steel</i>

**Art. LASTRA / LASTRALU**

Soffione a parete in acciaio inox AISI 304 satinato o lucido.

*Wall mounted showerhead in satin or polished stainless steel AISI 304.*

**Art. BILASTRA / BILASTRALU**

Soffione a parete con cascata in acciaio inox AISI 304 satinato o lucido.

N.B. Necessita di deviatore a due vie.

*Wall mounted waterfall showerhead in satin or polished stainless steel AISI 304.*

*P.S. Requires two way diverter.*

Art. LASTRA / LASTRALU

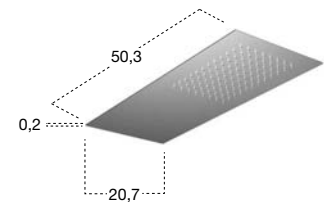

Art. BILASTRA / BILASTRALU

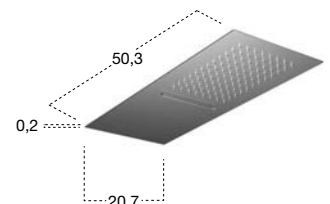



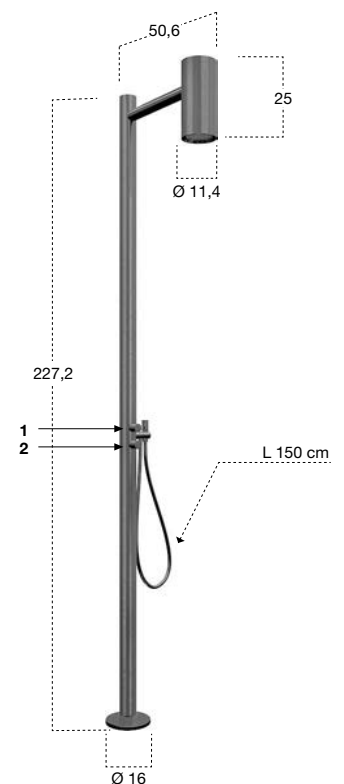

H	P	Ø	art.
227,2	50,6	11,4	SHAWA2

Colonna doccia da terra per interno o esterno, in acciaio inox satinato AISI 316/L, completa di corpo ad incasso, soffione, miscelatore (2), rubinetto di comando con deviatore a due vie (1) e doccetta con flessibile 150 cm.

*Freestanding shower for internal and external use, in satin stainless steel AISI 316/L complete with concealed valve, overhead shower, mixer (2), command handle with two way diverter (1) and hand shower with hose 150 cm.*