

# PANTA REI

2006

design\_Carlo Colombo

Eccellenza che diventa esclusività, per un lusso contemporaneo fatto di linee pulite e forme essenziali, materiali naturali e dettagli preziosi che trasmettono armonia ed equilibrio all'insieme.

La qualità unica delle lavorazioni unita alla possibilità di scegliere dimensioni, colori e finiture fanno di Panta Rei una collezione sartoriale all'insegna dell'eccellenza. I mobili, disponibili in finitura laccata o in essenza e i lavabi della collezione, comunicano un universo di valori e principi fondanti nei quali la qualità diventa il filo conduttore del progetto, in grado di sollecitare un mondo di sensazioni intime e arcaiche, di riti che si ripetono nel tempo, di abitudini che si trasformano nel segno della continuità.

Un'identità forte, nella quale gli spessori dei contenitori, esteticamente importanti, sono alleggeriti e sollevati da terra dallo zoccolo smussato e dal particolare taglio a 45° dei profili, che oltre a snellire in maniera significativa anche le sezioni a forte spessore, contribuisce a migliorare la qualità estetica complessiva dell'insieme. La perfezione raggiunta con Panta Rei nella laccatura e nell'impiallacciatura ha segnato un punto di svolta per antoniolupi, ha definito uno standard d'eccellenza che è stato da quel momento trasmesso a tutta la produzione. Da quel momento in poi il livello qualitativo diventerà il parametro di riferimento per ogni prodotto, l'attenzione ai dettagli il tratto distintivo di un modo di operare e prima di tutto di pensare.

La preziosità del legno, il calore delle essenze più ricercate, l'uniformità perfetta dei laccati opachi, i riflessi dei lucidi: la materia diventa design con Panta Rei, la qualità di ogni singolo elemento viene messa a servizio dell'immagine complessiva, del dialogo con le forme dei lavabi, della capacità di interpretare lo spazio, della volontà di definire un ambiente bagno senza confini.

*Excellence that becomes exclusive for contemporary luxury made of clean lines and basic shapes, natural materials and precious details that convey harmony and balance.*

*The unique quality of workmanship coupled with the ability to choose sizes, colors and finishes make Panta Rei a tailored collection characterized by excellence. The furniture, available in a lacquered or wood finish communicate with the sinks of the collection.*

*A strong identity, in which the thicknesses of the cabinets, aesthetically important, are lightened and raised from the ground by the beveled plinth and details cut at 45°. The lacquering and veneering achieved with the Panta Rei collection clearly marked a turning point for the company setting a standard of excellence transmitted to the rest of the production. From that moment on, the quality will become the benchmark for each product, the attention to detail; the hallmark of a way of working and thinking.*

*The preciousness of the woods, warmth from the most sought after materials, the perfect uniformity of the matt lacquers and the reflections of the glossy colours: matter becomes design with Panta Rei. The quality of each element is put in the service of the overall image, dialogue with the shapes of the sinks, the ability to interpret the space, the desire to define a bathroom environment without borders.*



PANTA REI



Lo specchio è un art. VARIO50W, L 180 cm, H 50 cm con due coppie di lampade art. BOLLA2, la composizione sottostante di L 180 cm, P 54 cm, H 37,5 cm è formata dal mobile in Rovere thermo art. PI14180 e dal top in Flumood art. BC254 colore Falena con buca integrata, art. NIDO54.  
Il rubinetto AYATI è un art. AY301LU.



*The mirror is art. VARIO50W, L 180 cm, H 50 cm with a pair of lamps art. BOLLA2, the composition below is L 180 cm, D 54 cm, H 37,5 cm is made up of cabinet art. PI14180 in Rovere thermo and top in Flumood Falena art. BC254 with integrated basin art. NIDO54. The AYATI tap is art. AY301LU.*

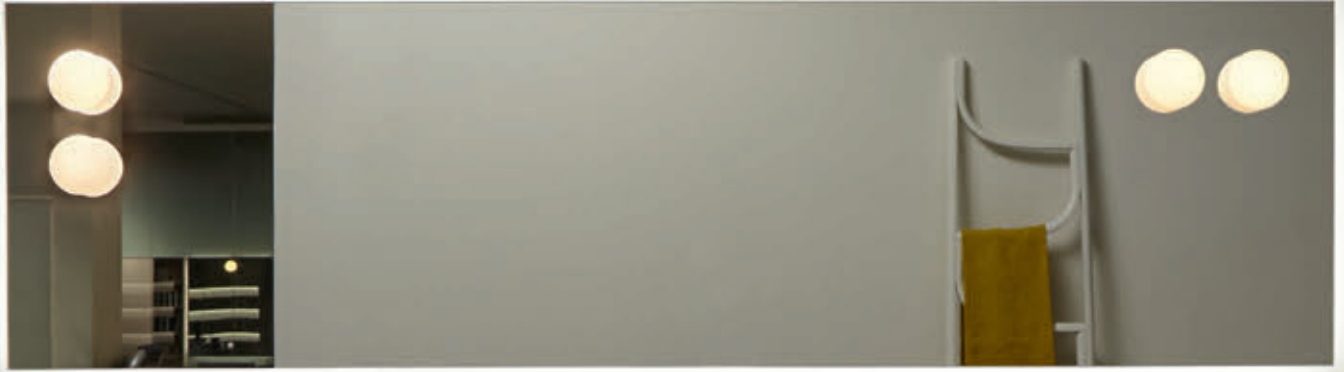



PANTA REI

La composizione è arricchita dall'inserimento del pianetto copripiletta art. PIANETTO1, dai cassetti interni opzionali art. SLIM54 e dall'attrezzatura STRATO in vetro fumé.

*The composition is completed with the drain cover art. PIANETTO1 and the internal optional drawers art. SLIM54 with STRATO drawer dividers in fumé glass.*



Questa composizione comprende lo specchio retroilluminato art. NEUTROLED75W, L 180 cm H 75 cm, rubinetteria INDIGO art. ND921, art. ND601, finitura acciaio satinato.

Il mobile, in legno Rovere castano, è composto da un modulo asimmetrico art. PI14180 versione dx; si completa con l'attrezzatura interna STRATO in vetro fumè art. SRC5490 e art. SRC5445.

Il top in Colormood Basalto art. BC254 L 180 cm P 54 cm Sp 1,2 cm, ospita un lavabo integrato art. NUVOLA Prof. 54 cm.

Tappeto della collezione GEOMETRIE VOLANTI art. GV336 L 300 cm P 200 cm.

*This composition includes the backlit mirror art. NEUTROLED75W L 180 cm H 75 cm INDIGO tap art. ND921 and art. ND601 in satin steel finish. The cabinet is in Rovere castano art. PI14180 right-hand version is completed with internal drawer accessories STRATO in fume glass art. SRC5490 and art. SRC5445*

*The top is in Colormood Basalto art. BC254 L 180 cm D 54 cm 1,2 cm thick houses an integrated sink art. NUVOLA 54 cm D. Carpet from GEOMETRIE VOLANTI collection art. GV336 L 300 cm D 200 cm*



PANTA REI





Questa composizione comprende due specchi retroilluminati art. CIRCUS108W, rubinetteria INDIGO art. ND921, art. ND601, finitura cromo lucido. Il mobile, verniciato gofrato Meringa, è composto da una base art. PI4180, due porta lavabi art. PI5490 e due basi art. PI5654. I due lavabi in appoggio art. RIM76 sono in Flumood Bianco. Vasca art. REFLEXMOOD in Flumood Bianco, rubinetteria INDIGO art. ND903 finitura cromo lucido. I tre scaldasalviette, art. STECCA120, L 120 cm P 7 cm H 12 cm sono verniciati gofrati nei colori Bambola, Veneziano e Pompeiano. Tappeto della collezione GEOMETRIE VOLANTI art. GV329 L 300 cm P 200 cm.



*This composition includes two backlit mirrors art. CIRCUS108W, INDIGO tap series art. ND921 art. ND601 polished chrome finish. The cabinets lacquered embossed Meringa have a cabinet art. PI4180, two sink units art. PI5490 and two cabinets art. PI5654. The two top mount sinks are art. RIM76 in white Flumood. Bathtub art. REFLEXMOOD in white Flumood INDIGO tap art. ND903 polished chrome. The three towel warmers art. STECCA120 L 120 are lacquered embossed Bambola, Veneziano and Pompeiano. Carpet from the GEOMETRIE VOLANTI art. GV329 L 300 cm D 200 cm.*









PANTA REI





Questa composizione comprende lo specchio art. COLLAGE365 L 54 cm H 75 cm, rubinetteria INDIGO art. ND921 e art. ND601 finitura grafite. Il mobile, verniciato goffrato Veneziano, è composto da due basi art. PI5472 e una base art. PI5672 e contiene l'attrezzatura interna STRATO in vetro fumè art. SRC5472. Il top scatolare in Flumood Falena art. BCS54, L 216 cm H 12,5 cm P 54 cm, ospita il lavabo in appoggio art. SENSOC in Cristalmood Nebbia; completa la composizione l'alzatina paraschizzi nella stessa finitura del top. Tappeto della collezione GEOMETRIE VOLANTI art. GV520 L 400 cm P 100 cm.

*This composition includes the mirror art. COLLAGE365 L 54 cm H 75 cm, INDIGO tap series art. ND921 and art. ND601 graphite finish. The cabinet is lacquered embossed Veneziano and is made up of two cabinets art. PI5472 with internal drawer accessories STRATO in fume glass art. SRC5472. The boxy top in Flumood Falena art. BCS54 L 216 cm H 12,5 cm D 54 cm houses a top mount sink art. SENSOC in Cristalmood Nebbia; to complete the composition the backsplash is in the same material as the top Carpet GEOMETRIE VOLANTI art. GV520 L 400 cm D 100 cm.*







A sinistra la composizione è formata dai sanitari sospesi art. KOMODO3 e art. KOMODO4 satinati, rubinetteria INDIGO art. ND400 finitura grafite, placca art. ONDA finitura grafite. A parete la mensola e la colonna a giorno da incasso art. DIMEZZO e art. FRAMEZZO entrambe in finitura Skin cenere. Completa la composizione lo scaldasalviette art. STECCA60, L 60 cm H 12 cm P 7 cm verniciato gofrato Tortora. Sopra vasca in Cristalplant art. DUNE2 e portasalviette art. HALO4A con basamento in marmo Carrara satinato, struttura finitura Bianca opaco e vassoio in Flumood Bianco.

To the left the composition is made up of suspended sanitary ware art. KOMODO3 and art. KOMODO4 in a satin finish, INDIGO tap art. ND400 in the graphite finish, flush plate art. ONDA in graphite. Encased in the wall art. DIMEZZO and art. FRAMEZZO both in Skin cenere. Towel warmer art. STECCA60 L 60 cm H 12 cm D 7 cm lacquered embossed Tortora. Above the Cristalplant bathtub art. DUNE2 and towel holder art. HALO4A with base in satin Carrara marble, structure in matt white and tray in Flumood.





In questa composizione il mobile, verniciato goffrato Veneziano, è composto da due basi art. PI4180. A parete quattro pensili art. ICE6, L 72 cm H 25 cm P 14, con schienale verniciato Cipria lucido e vetro trasparente fumè.

*In this composition the cabinet lacquered embossed Veneziano is made up of two cabinets art. PI4180. On the wall four open cabinets art. ICE6 L 72 cm H 25 cm D 14 cm with back lacquered glossy Cipria and fume colored glass.*



Specchio art. NEUTROLED50W di L 180 cm, H 50 cm, rubinetteria AYATI art. AY921LU e art. AY600LU, lavabo da appoggio in Flumood Bianco art. BOLOMOOD45. Il mobile PANTA REI DOBLE è composto da due basi art. PI5645 di L 45 cm e da un porta lavabo art. PI5490 L 90 cm, tutti H 37,5 cm e P 54 cm, colore Terracotta lucido.

*Mirror art. NEUTROLED50W measuring L 180 cm, H 50 cm, AYATI taps art. AY921LU and art. AY600LU, top mount sink art. BOLOMOOD45 in white Flumood. The furniture PANTA REI DOBLE is made up of two cabinets art. PI5645 L 45 cm and one sink unit art. PI5490 L 90 cm all H 37,5 cm and D 54 cm, lacquered glossy Terracotta.*



Specchio art. NEUTROLED50W di L 216 cm, H 50 cm, rubinetteria AYATI art. AY921LU e art. AY600LU, e lavabo da appoggio in Flumood Bianco art. BOLOMOOD45. Il mobile PANTA REI DOBLE è composto da due basi art. PI5672 di L 72 cm e da un portalavabo art. PI5472 L 72 cm, H 37,5 cm e P 54 cm, colore Terracotta lucido.

*Mirror art. NEUTROLED50W measuring L 216 cm, H 50 cm, AYATI taps art. AY921LU and art. AY600LU, top mount sink art. BOLOMOOD45 in white Flumood. The furniture PANTA REI DOBLE is made up of two cabinets art. PI5672 L 72 cm and a sink unit art. PI5472 L 72 cm, H 37,5 cm and D 54 cm, lacquered glossy Terracotta.*





PANTA REI







PANTA REI

La composizione in colore Pomice gofrato è formata da cinque colonne art. PC1145 di L 45 cm, H 175 cm, P 22 cm.

*The composition is embossed lacquered Pomice and made up of five high cabinets art. PC1145, each is L 45 cm, H 175 cm, D 22 cm.*





Lo specchio a sinistra è un art. COLLAGE222, quello a destra è l'art. COLLAGE221, entrambi L 36 cm e H 108 cm, la composizione sottostante è l'art. PI22180 di L 180 cm, P 54 cm, H 37,5 cm in finitura Rovere thermo, più il top in Flumood Bianco art. BC254, con due buche integrate art. NIDO72 e pianetto opzionale art. PIANETTO2. I rubinetti sono della serie AYATI art. AY301SA in acciaio satinato.

*The mirror to the left is art. COLLAGE222, the one on the right is art. COLLAGE221, both L 36 cm and H 108 cm. The composition below is art. PI22180 measuring L 180 cm, D 54 cm H 37,5 cm in Rovere thermo with a top in white Flumood art. BC254 with two Integrated sinks art. NIDO72 and optional surface art. PIANETTO2. The tap series AYATI art. AY301SA in satin stainless steel.*

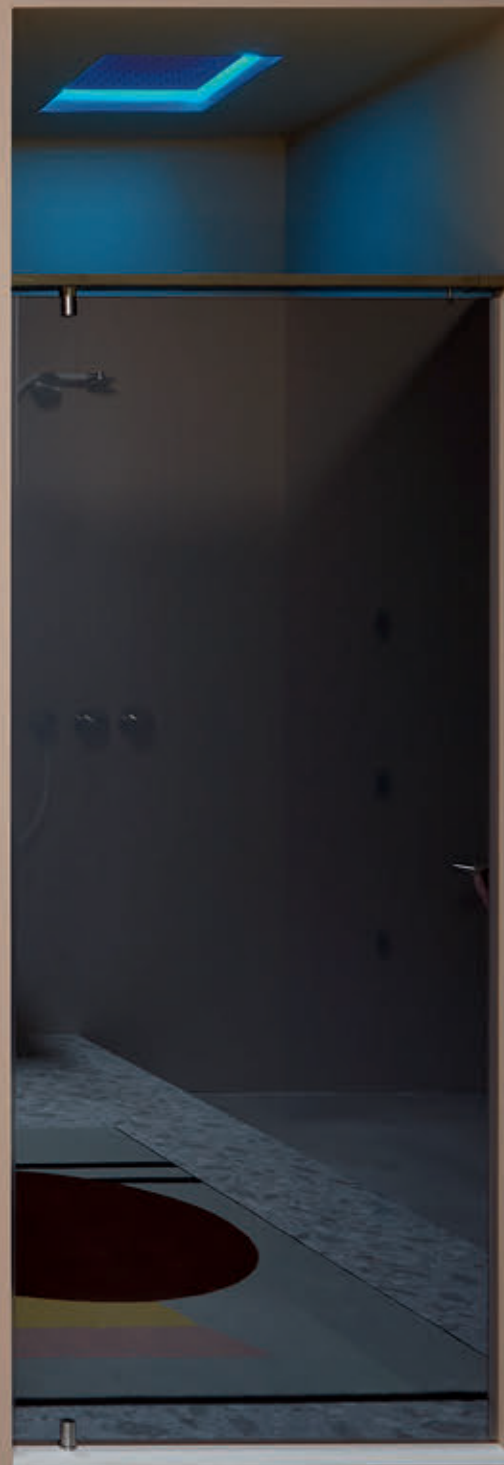



Questa composizione comprende due specchi art. MANTRA275 L 72 cm H 75 cm ciascuno, la rubinetteria è composta dall'erogatore AYATI art. AY921SA in finitura satinata e dal miscelatore art. MINIMAYDAY verniciato bianco. Il mobile, verniciato gofrato Bianco mood, è composto da una base art. PB4144 ed è completo di attrezzatura interna STRATO in vetro fumè art. SRC5472.

Il top scatolare in Flumood Bianco art. BCS54, L 144 cm H 12,5 cm P 54 cm, ospita il lavabo integrato art. OSM54.

*This composition is made up of two mirrors art. MANTRA275 L 72 cm each, Ayati tap art. AY921 in satin stainless steel and MINIMAYDAY mixer lacquered white. The cabinet lacquered embossed Bianco mood is made up of a cabinet art. PB4144 with internal drawer accessories STRATO in fume glass art. SRC5472.*

*The boxy top in white Flumood art. BCS54 L 144 cm H 12,5 cm D 54 cm with integrated sink art. OSM54.*





PANTA REI







Questa composizione comprende lo specchio art. VERTICE75W, L 216 cm H 75 cm, con specchio ingranditore FOCUS; rubinetteria AYATI art. AY921SA e art. AY600SA in finitura satinata. Il mobile, verniciato Cemento lucido, è composto da una base art. PI4180 e due porta lavabi art. PI4144 ed è completo di attrezzatura interna STRATO in vetro fumè. Il mobile ospita i due lavabi da appoggio art. OPALE10 in Cristalmood Ginger. A parete quattro pensili a giorno art. ICE6, L 72 cm H 25 cm P 14, con schienale verniciato Bianco opaco e vetro extrachiaro. Completa la composizione il tappeto della collezione GEOMETRIE VOLANTI art. GV52 L 400cm P 100 cm.

*This composition includes the mirror art. VERTICE75W, L 216 cm H 75 cm, with FOCUS magnifying mirror; AYATI taps art. AY921SA and art. AY600SA in satin finish. The cabinet is lacquered in glossy Cemento, is made up of a cabinet art. PI4180 and two sink units art. PI4144 and is complete with STRATO internal drawer accessories in fumè glass. The cabinet houses the two top mount sinks art. OPALE10 in Cristalmood Ginger. Four open wall units art. ICE6, L 72 cm H 25 cm D 14, with matt white painted back and extra-clear glass. The composition is completed by the carpet from the GEOMETRIE VOLANTI collection art. GV52 L 400cm P 100 cm.*



La composizione comprende tre mobili, due in essenza Noce biondo L 162 cm, P 54 cm, H 25 cm, art. PB24162 e uno laccato Bianco opaco di L 216 cm, H 25 cm, P 54 cm, art. PB4216. I lavabi sono in Pietra Luna art. PILA11, con rubinetteria BIKAPPA finitura lucida art. BK200N. Lo specchio L 162 cm, H 75 cm, art. FLASH75W.



PANTA REI

*The composition Includes three cabinets, two in Noce biondo L 162 cm, D 54 cm, H 25 cm, art. PB24162 and one lacquered matt Bianco L 216 cm, H 25 cm, D 54 cm, art. PB4216. The sinks in Pietra Luna art. PILA11 with BIKAPPA polished finish tap art. BK200N. The mirror L 162 cm, H 75 cm, art. FLASH75W.*





PANTA REI





La composizione comprende uno specchio su misura, un mobile L 180 cm, P 54 cm, H 25 cm, laccato Bianco opaco, art. PB4180.  
Lavabo in Flumood Bianco art. URNAMOOD. La rubinetteria è BIKAPPA in finitura lucida art. BK905N.

*The composition includes a special size mirror, cabinet L 180 cm, D 54 cm, H 25 cm lacquered matt Bianco art. PB4180. sinks in white  
Flumood art. URNAMOOD. Polished BIKAPPA tap art. BK905N.*







Composizione con un mobile L 216 cm, P 54 cm, H 37,5 cm, in essenza Noce biondo art. PI4216, con zoccolo laccato Nero goffrato, art. PZ54, ed un mobile laccato Bianco opaco art. PB4216. Lavabo in Flumood Bianco art. URNAMOOD. La rubinetteria è BIKAPPA in finitura lucida art. BK905N. Lo specchio art. FLASH50W è L 216 cm, H 50 cm.

*The composition with cabinet L 216 cm, D 54 cm, H 37,5 cm in Noce biondo art. PI4216, Nero embossed lacquered plinth art. PZ54 and a lacquered cabinet matt Bianco art. PB4216. Sink in white Flumood art. URNAMOOD. Polished BIKAPPA tap art. BK905N. The mirror art. FLASH50W L 216 cm, H 50 cm.*



La composizione comprende tre mobili, due in essenza Rovere grigio L 180 cm, P 54 cm, H 25 cm, art. PB4180 e uno laccato Bianco opaco di L 180 cm, H 25 cm, P 54 cm, art. PB4180. Il lavabo è in Flumood Bianco art. URNAMOOD e la rubinetteria è BIKAPPA finitura lucida art. BK200N. Lo specchio, L 180 cm H 75 cm art. FLASH75W.

*The composition includes three cabinets, two in Rovere grigio L 180 cm, D 54 cm, H 25 cm, art. PB4180 and one lacquered matt Bianco L 180 cm, H 25 cm, D 54 cm, art. PB4180. Sink in white Flumood art. URNAMOOD and BIKAPPA polished finish tap art. BK200N. The mirror L 180 cm H 75 cm art. FLASH75W.*



PANTA REI





La composizione comprende tre mobili, un porta lavabo L 72 cm, P 54 cm, H 50 cm, in essenza Rovere sbiancato art. PA272, un porta lavabo L 90 cm, P 54 cm, H 25 cm, art. PB290 laccato Bianco opaco, una base L 108 cm, P 54 cm, H 25 cm, art. PB2108 in essenza Rovere sbiancato. I lavabi art. URNAMOOD, sono in Flumood Bianco, la rubinetteria è BIKAPPA finitura lucida, art. BK200N. Lo specchio è art. NEUTROLED142W L 72 cm H 142 cm.

*The composition includes three cabinets, one sink unit L 72 cm, D 54 cm, H 50 cm in Rovere sbiancato art. PA272, a sink unit L 90 cm, D 54 cm, H 25 cm, art. PB290 lacquered matt Bianco, a cabinet L 108 cm, D 54 cm, H 25 cm, art. PB2108 in Rovere sbiancato. The sinks art. URNAMOOD, in white Flumood, BIKAPPA polished finish tap art. BK200N. Mirror art. NEUTROLED142W L 72 cm H 142 cm.*





La composizione comprende uno specchio art. FLASH100W, rubinetteria AYATI in finitura lucida, art. AY921LU e art. AY600LU. Il mobile è composto da due moduli, ognuno di L 144 cm, H 37,5 cm, P 54 cm, art. PI4144 laccati Ovatta lucido. Lavabi da appoggio in Flumood Bianco art. RETTOMOOD50. Di lato alla composizione, il camino CANTO DEL FUOCO art. CANTOMC63 con bruciatore art. LAFLACA.

*The composition includes a mirror art. FLASH100W, AYATI taps in a polished finish art. AY921LU and art. AY600LU. The furniture is made up of two cabinets each L 144 cm, H 37,5 cm, D 54 cm, art. PI4144 lacquered glossy Ovatta. White Flumood top mount sinks art. RETTOMOOD50. Next to the composition is a fireplace CANTO DEL FUOCO art. CANTOMC63 and burner art. LAFLACA.*







La composizione in essenza Rovere grigio, comprende due moduli di L 216 cm, P 54 cm, H 25 cm, art. PB4216 e art. PB20216, due lavabi in Flumood Bianco art. RETTOMOOD63, rubinetteria AYATI, finitura satinata, art. AY921SA e art. AY600SA. Lo specchio L 216 cm, H 75 cm, è l'art. FLASH75W. I pensili art. PE136, L 36 cm, H 75 cm, sono laccati Cemento opaco; i sanitari in ceramica satinata sono l'art. KOMODO3 e l'art. KOMODO4. Completano la composizione, gli accessori della collezione TAPE, in acciaio inox satinato AISI 304, come la placca di comando art. ONDA.

*The composition in Rovere grigio includes two cabinets L 216 cm, D 54 cm, H 25 cm, art. PB4216 and art. PB20216, two white Flumood sinks art. RETTOMOOD63, AYATI taps in a satin finish art. AY921SA and art. AY600SA. The mirror L 216 cm, H 75 cm, is art. FLASH75W. Wall cabinets art. PE136, L 36 cm, H 75 cm, are lacquered matt Cemento; the sanitary ware in satin ceramic art. KOMODO3 and art. KOMODO4. To complete the composition are the TAPE accessories in satin stainless steel AISI 304 as is the plate art. ONDA.*





A sinistra, la composizione comprende uno specchio L 36 cm, H 108 cm, art. SPIO4W, un mobile in Rovere matita L 180 cm, H 37,5 cm, P 54 cm, art. PI4180. Lavabo in Flumood Bianco, art. FOGLIOMOOD63 e rubinetteria BIKAPPA in finitura lucida art. BK200N. Sopra, soluzione con rubinetteria AYATI in finitura satinata art. AY200SA.

*On the left, the composition includes a mirror L 36 cm, H 108 cm, art. SPIO4W, a cabinet in Rovere matita L 180 cm, H 37,5 cm, D 54 cm, art. PI4180. White Flumood sink art. FOGLIOMOOD63 and BIKAPPA taps in polished chrome finish art. BK200N. Above solution with the AYATI tap in satin art. AY200SA.*





La composizione comprende un mobile art. PA10216, L 216 cm, P 54 cm, H 50 cm, laccato Grigio vesuvio opaco, sopra i due lavabi in Pietra Vesuvio art. PILA11. La rubinetteria è BIKAPPA in finitura lucida art. BK200N. Gli specchi sono L 36 cm, H 108 cm, art. SPIO4W.

*The composition includes a cabinet art. PA10216, L 216 cm, D 54 cm, H 50 cm lacquered matt Grigio Vesuvio with two sinks art. PILA11 in Pietra Vesuvio. Polished BIKAPPA tap art. BK200N. Mirrors L 36 cm, H 108 cm, art. SPIO4W.*





PANTA REI

La composizione comprende uno specchio art. FLASH75W, L 180 cm, H 75 cm, il mobile art. PI4180, L 180 cm, P 54 cm, H 37,5 cm e il top in Corian L 180 cm, art. CR254, con lavabo integrato art. MYSLOT90. La rubinetteria è BIKAPPA in finitura lucida art. BK200N.

*The composition includes mirror art. FLASH75W, L 180 cm, H 75 cm. The cabinet art. PI4180, L 180 cm, D 54 cm, H 37,5 cm and the top in Corian L 180 cm, art. CR254 with integrated sink art. MYSLOT90. Polished BIKAPPA tap art. BK200N.*







PANTA REI

La composizione in alto comprende un pensile con anta a specchio art. SEGRETO, la rubinetteria AYATI è in finitura lucida, art. AY302LU, il top in Corian art. CR254 con lavabo integrato è l'art. SEGNO90 e il mobile PANTA REI CENTRO, L 180 cm, H 50 cm, P 54 cm, art. PA36180 è laccato Ovatta gofrato. Gli accessori sono della collezione PLAY.

*The composition on top includes a wall cabinet with mirrored door art. SEGRETO, AYATI tap in the polished finish art. AY302LU, Corian top art. CR254 with integrated sink art. SEGNO90 and the cabinet PANTA REI CENTRO, L 180 cm, H 50 cm, D 54 cm, art. PA36180 lacquered embossed Ovatta. Accessories from the PLAY series.*





La composizione in alto comprende uno specchio art. NEUTROLED75W di L 216 cm, H 75 cm, la rubinetteria AYATI in finitura satinata art. AY200SA e due lavabi da appoggio in Flumood Bianco art. CATINO. Il mobile PANTA REI CENTRO art. PA32216 è di L216 cm, H 50 cm e P 54 cm, laccato Cemento lucido.

*The composition above has a mirror art. NEUTROLED75W L 216 cm, H 75 cm, the AYATI tap in satin finish art. AY200SA and two top mount sinks in white Flumood art. CATINO. The cabinet PANTA REI CENTRO art. PA32216 is L 216 cm, H 50 cm and D 54 cm lacquered glossy Cemento.*



Composizione con uno specchio L 216 cm, H 75 cm, art. FLASH75W, un mobile L 216 cm, P 54 cm, H 25 cm, in essenza Rovere castano art. PB4216. Top in Corian art. CRS15, con due lavabi integrati art. SLOT. La rubinetteria BIKAPPA è in finitura lucida art. BK200N.

*Composition with a mirror L 216 cm, H 75 cm, art. FLASH75W, a cabinet L 216 cm, D 54 cm, H 25 cm in Rovere castano art. PB4216. Top in Corian art. CRS15 with two integrated sinks art. SLOT. Polished BIKAPPA tap art. BK200N.*



PANTA REI





La composizione comprende due specchi art. FLASH100W e due top in essenza Noce canaletto L 144 cm, H 12,5 cm art. BANCO154, due lavabi da appoggio in Flumood Bianco art. URNAMOOD. La rubinetteria è AYATI in finitura satinata art. AY921SA e art. AY600SA. Il mobile PANTA REI CENTRO laccato Strada opaco L 72 cm, H 50 cm, P 54 cm, art. PA2672.

*The composition has two mirrors art. FLASH100W and two tops in Noce canaletto L 144 cm, H 12,5 cm art. BANCO154, two sinks in white Flumood art. URNAMOOD. The AYATI tap in the satin finish art. AY921SA and art. AY600SA. The cabinet PANTA REI CENTRO lacquered matt Strada L 72 cm, H 50 cm, D 54 cm, art. PA2672.*







La composizione comprende uno specchio art. NEUTROLED90W e uno art. NTKIT50W, rubinetteria AYATI, art. AY301LU da piano e art. AY921LU art. AY600LU, da parete. Top in Flumood Bianco, art. BCS54, con lavabi sopra piano art. SIMPLOTONDO e art. SIMPLO42. Il mobile L 216 cm, H 37,5 cm, P 47 cm, è laccato colore Cipria lucido art. PIM10216.

*The composition includes a mirror art. NEUTROLED90W and one mirror art. NTKIT50W, AYATI taps art. AY301LU on the sink and art. AY921LU and art. AY600LU, wall mounted. Top in white Flumood art. BCS54 with top mount sinks art. SIMPLOTONDO and art. SIMPLO42. The cabinet L 216 cm H 37,5 cm D 47 cm is lacquered glossy color Cipria art. PM10216.*



Il mobile, L 216 cm, H 37,5 cm, P 54 cm art. PI10216 è laccato Mostarda opaco e corredato di zoccolo H 5 cm, laccato Nero goffrato art. PZ54.

*The furniture L 216 cm, H 37,5 cm, D 54 cm, art. PI10216 is lacquered matt Mostarda, has an embossed lacquered Nero plinth H 5 cm art. PZ54.*



Pensile con anta a specchio L 162 cm, H 50 cm, P 32 cm, art. SEGRETO, laccato Mostarda opaco; top in Flumood Bianco L 216 cm, H 12,5 cm, P 54 cm, art. BCS54, con lavabo in Flumood Bianco art. RETTOMOOD63 e rubinetteria AYATI in finitura lucida art. AY200LU. Il mobile L 216 cm, H 25 cm, P 54 cm, laccato Ovatta opaco è l'art. PB10216.

*Wall cabinet with mirrored front L 162 cm, H 50 cm, D 32 cm, art. SEGRETO, lacquered matt Mostarda; top in white Flumood finish L 216 cm, H 12,5 cm, D 54 cm, art. BCS54 with white Flumood sink art. RETTOMOOD63 and AYATI tap in the polished finish art. AY200LU. The furniture L 216 cm, H 25 cm, D 54 cm, is lacquered matt Ovatta art. PB10216.*





La composizione comprende, sei pensili L 72 cm e L 27 cm, H 25 cm, P 14 cm, in vetro extrachiaro con schienale laccato Matita e Grigio fango opaco. Il mobile PANTA REI XL è composto da due basi L 72 cm, art. PA4872 e da un porta lavabo L 72 cm, art. PA4672, la composizione è P 54 cm e H 50 cm, in essenza Noce canaletto. Il top è in Corian, L 216 cm, P 54 cm, art. CR254 con lavabo integrato art. SEGNO72; la rubinetteria è AYATI in finitura satinata art. AY301SA. Lo specchio è L 72 cm, H 90 cm, art. FLASH90W.

*The composition includes six wall cabinets L 72 cm and L 27 cm, H 25 cm, D 14 cm in extra clear glass with lacquered back, colors matt Matita and Grigio fango. The cabinet PANTA REI XL is composed of two elements L 72 cm, art. PA4872 and a sink unit L 72 CM, art. PA4672. The composition is D 54 cm and H 50 cm in Noce canaletto. Corian top L 216 cm, D 54 cm, art. CR254 with integrated sink art. SEGNO72; satin AYATI tap art. AY301SA. Mirror L 72 cm, H 90 cm, art. FLASH90W.*





La composizione laccata Matita opaco, comprende due pensili con anta a specchio, completi di illuminazione, L 54 cm, H 50,5 cm, P 14,7 cm art. MANTRA150. I due mobili PANTA REI XL sono formati da due basi di L 72 cm art. PA4772 e due porta lavabi L 54 cm, P 40 cm e H 50 cm art. PA4554. I lavabi sono in Flumood Bianco, art. GESTOMOOD54 e la rubinetteria è AYATI in finitura lucida art. AY301LU.

*The lacquered composition matt Matita includes two wall cabinets with mirrored door, complete with lighting, L 54 cm, H 50,5 cm, D 14,7 cm art. MANTRA150. The PANTA REI XL furniture are made up of two cabinets L 72 cm art. PA4772 and two sink units L 54 cm, D 40 cm and H 50 cm art. PA4554. Sinks in white Flumood art. GESTOMOOD54 and polished AYATI tap art. AY301LU.*





**PANTA REI LEGENDA - KEY**

Gli elementi di questa collezione sono verniciati internamente ed esternamente.

The elements of this collection are lacquered both internally and externally.

**A**



Bianco lucido/colorato opaco o gofrato, come da nostro campionario colori

*Glossy white/Matt lacquered or embossed, as per our colour samples*



**D**



Colorato lucido/finitura seta, come da nostro campionario colori

*Glossy lacquered/Silk finish, as per our colour samples*



**B**



Rovere: sbiancato, naturale castano, moro, grigio, matita, ardesia.

**E**



Rovere: thermo.  
Noce: canadese, visone, canaletto.

**PANTA REI**  
H 25 - 37,5 - 50

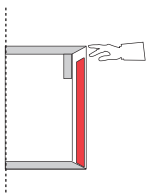
Soluzione 1 cassetto con apertura superiore.

*Solution with 1 upper opening drawer.*

**PANTA REI CENTRO**  
H 50

Soluzione 2 cassetti con apertura centrale.

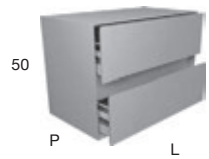
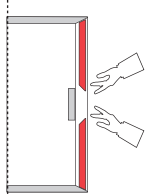
*Solution with 2 center opening drawers.*

**PANTA REI XL**  
H 37,5 / 50

Soluzione 1 cassetto con apertura superiore e 1 vano a giorno.

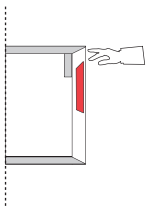
*Solution with 1 upper opening drawer and 1 open compartment.*

**PANTA REI DOBLE**  
H 37,5

Soluzione 2 cassetti con apertura superiore ed inferiore.

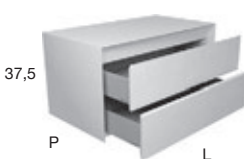
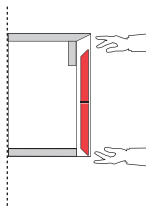
*Solution with 2 drawers 1 upper opening and 1 bottom opening.*

**PANTA REI COMPONENTI - COMPONENTS**

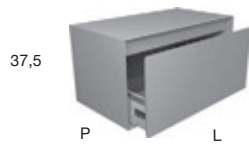

H	P	L
25	40	36 - 45 - 54 - 72 - 90 - 108
37,5	47	
50	54	

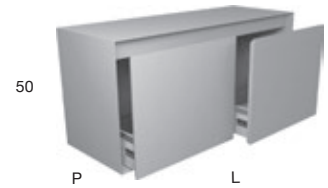

H	P	L
25	40	72 (36+36) - 90 (45+45) - 108 (54+54) - 144 (72+72) - 180 (90+90) - 216 (108+108)
37,5	47	
50	54	

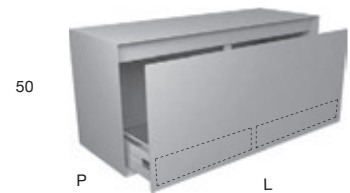
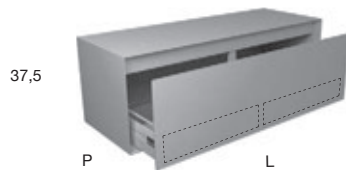

H	P	L
25	40	144 (72+72) / 180 (90+90)
37,5	47	
50	54	



H	P	L
25	40	108 (72+36) / 126 (72+54) / 135 (90+45) / 144 (90+54) / 144 (108+36) / 162 (90+72) / 162 (108+54)
37,5	47	
50	54	

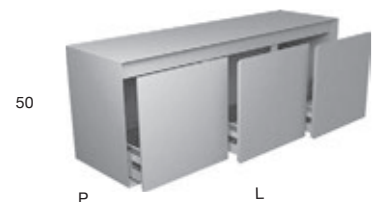

H	P	L
25	40	108 (36+36+36) / 135 (45+45+45) / 162 (54+54+54) / 216 (72+72+72)
37,5	47	
50	54	

PANTA REI COMPONENTI - COMPONENTS

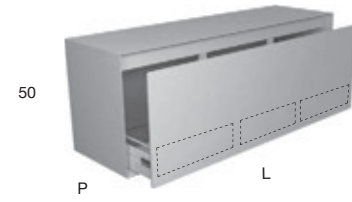
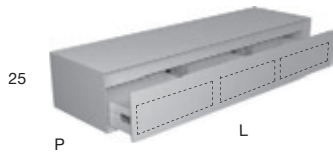

H	P	L
25	40	135 (45+45+45) / 162 (54+54+54)
37,5	47	
50	54	



H	P	L
25	40	144 (72+36+36) / 162 (90+36+36) / 180 (90+45+45) / 180 (108+36+36) / 216 (108+54+54)
37,5	47	
50	54	

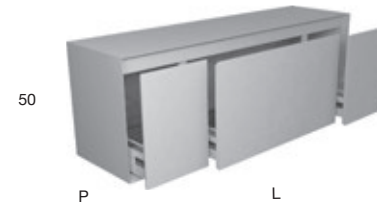

H	P	L
25	40	144 (36+72+36) / 162 (36+90+36) / 180 (45+90+45)
37,5	47	
50	54	



H	P	L
25	40	180 (72+36+72) / 216 (90+36+90)
37,5	47	
50	54	



H	P	L
25	40	180 (72+72+36) / 216 (90+90+36)
37,5	47	
50	54	

PANTA REI

**PANTA REI CENTRO COMPONENTI - COMPONENTS**

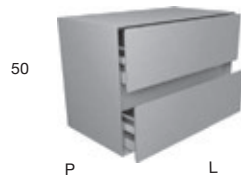

H	P	L
50	40	36 - 45 - 54 - 72 - 90 - 108
		47
		54

H	P	L
50	40	72 (36+36) - 90 (45+45) - 108 (54+54) - 144 (72+72) - 180 (90+90) - 216 (108+108)
		47
		54

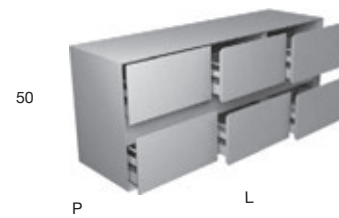

H	P	L
50	40	108 (72+36) - 126 (72+54) - 135 (90+45)
		47 144 (90+54) - 144 (108+36) - 162 (90+72) - 162 (108+54)
		54

H	P	L
50	40	108 (36+36+36) - 135 (45+45+45) - 162 (54+54+54) - 216 (72+72+72)
		47
		54



H	P	L
50	40	144 (72+36+36) - 162 (90+36+36) - 180 (90+45+45)
		47 180 (108+36+36) - 216 (108+54+54)
		54

H	P	L
50	40	144 (36+72+36) - 162 (36+90+36) - 180 (45+90+45)
		47
		54

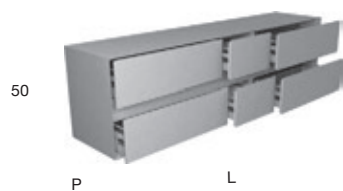

H	P	L
50	40	180 (72+36+72) - 216 (90+36+90)
		47
		54

H	P	L
50	40	180 (72+72+36) - 216 (90+90+36)
		47
		54



PANTA REI

**PANTA REI XL COMPONENTI - COMPONENTS**

In fase di ordine indicare il tipo di composizione scegliendo la lettera di riferimento (A,B,C,D,E,F,G), le misure dei componenti e la versione desiderata. Il mobile verrà composto in azienda e arriverà al cliente già montato come da soluzione scelta. Di seguito troverete un esempio esplicativo di come ordinare un mobile appartenente alla soluzione D. Le soluzioni A e B possono essere utilizzate con lavabi a parete, con lavabi da terra, oppure possono essere inseriti singolarmente in spazi living.

Specify at time of order the type of configuration among the proposed solutions (A,B,C,D,E,F,G) together with desired size of units and selected category. The modules will be assembled at the company and will be delivered to the client as per selected configuration. Find below an example of how to order one configuration belonging to solution D. Solution A and B are suitable for wall-mounted sinks, freestanding sinks or can be placed as an independent unit in a living room.

**ESEMPIO MOBILE DA ORDINARE | EXAMPLE OF CONFIGURATION TO ORDER**

**D SOLUZIONE | CONFIGURATION**

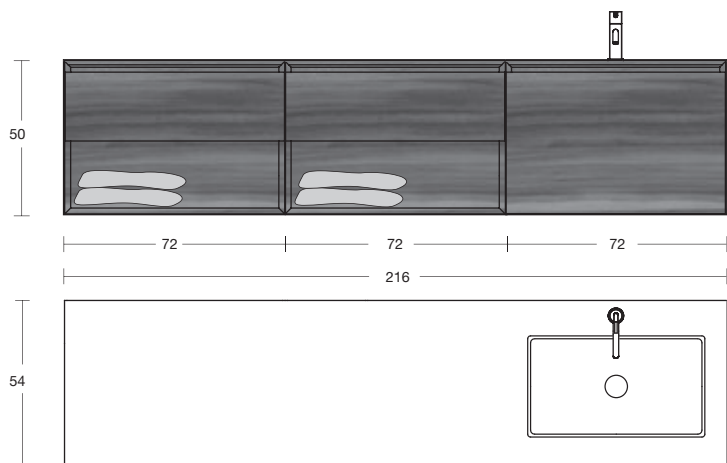

Versione dx - Right version



+

N° 2 ART. PA4872 L 72  
Base con 1 cassetto e 1 vano a giorno  
Cabinet with 1 drawer and 1 open compartment



+  
ART. PA4672 L 72  
Portalavabo con 1 cassetto  
Sink unit with 1 drawer



+  
ART. BC254 + ART. NIDO72 L 216  
Top con lavabo integrato  
Top with integrated sink



+  
ART. AY301SA/AY301LU  
Miscelatore monocomando  
Single lever mixer

**SOLUZIONI LIVING | LIVING CABINETRY CONFIGURATIONS**

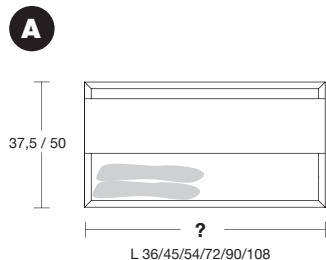

Base con 1 cassetto e 1 vano a giorno  
Cabinet with 1 drawer and 1 open compartment

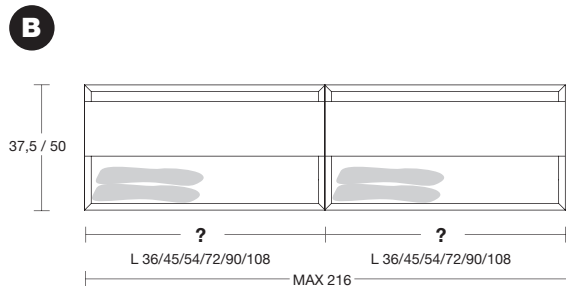

Base con 1 cassetto e 1 vano a giorno  
Cabinet with 1 drawer and 1 open compartment



+

Base con 1 cassetto e 1 vano a giorno  
Cabinet with 1 drawer and 1 open compartment



SOLUZIONI CON PORTALAVABO | CONFIGURATIONS WITH SINK UNIT

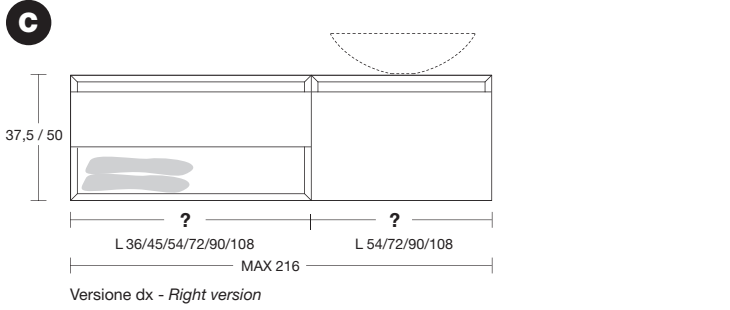

Base con 1 cassetto e 1 vano a giorno  
Cabinet with 1 drawer and 1 open compartment



Portalavabo con 1 cassetto  
Sink unit with 1 drawer

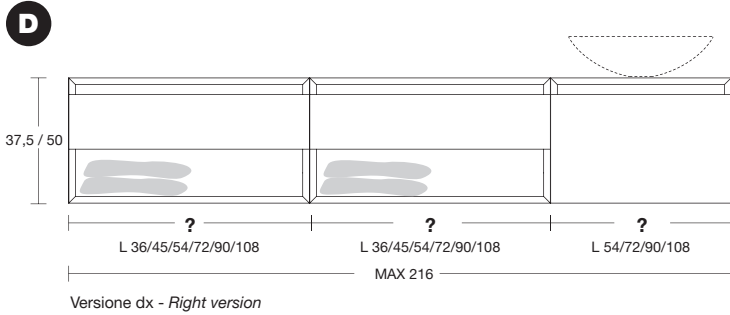

Base con 1 cassetto e 1 vano a giorno  
Cabinet with 1 drawer and 1 open compartment



Base con 1 cassetto e 1 vano a giorno  
Cabinet with 1 drawer and 1 open compartment



Portalavabo con 1 cassetto  
Sink unit with 1 drawer

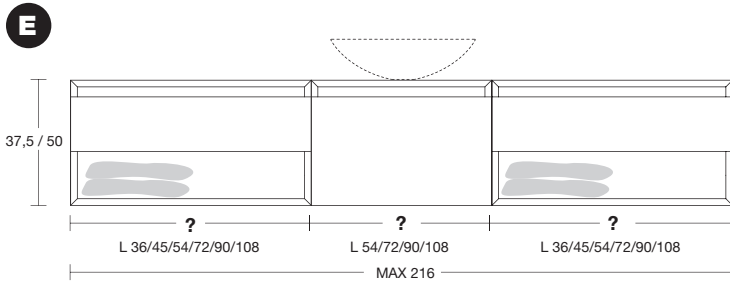

Base con 1 cassetto e 1 vano a giorno  
Cabinet with 1 drawer and 1 open compartment



Portalavabo con 1 cassetto  
Sink unit with 1 drawer



Base con 1 cassetto e 1 vano a giorno  
Cabinet with 1 drawer and 1 open compartment

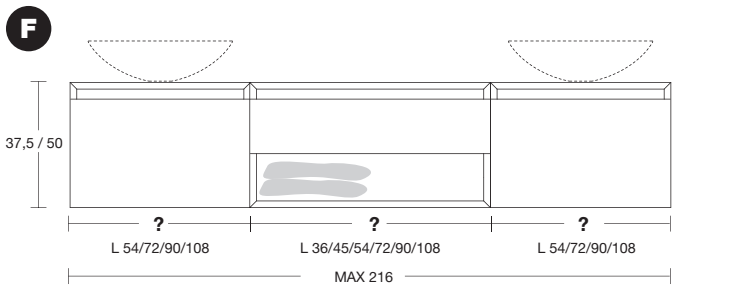

Portalavabo con 1 cassetto  
Sink unit with 1 drawer



Base con 1 cassetto e 1 vano a giorno  
Cabinet with 1 drawer and 1 open compartment



Portalavabo con 1 cassetto  
Sink unit with 1 drawer

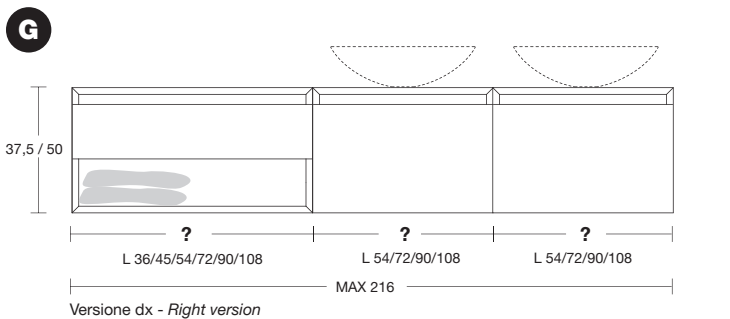

Base con 1 cassetto e 1 vano a giorno  
Cabinet with 1 drawer and 1 open compartment



Portalavabo con 1 cassetto  
Sink unit with 1 drawer



Portalavabo con 1 cassetto  
Sink unit with 1 drawer





**PANTA REI DOBLE COMPONENTI - COMPONENTS**

In fase di ordine indicare il tipo di composizione scegliendo la lettera di riferimento (A,B,C,D,E,F,G), le misure dei componenti e la versione desiderata. Il mobile verrà composto in azienda e arriverà al cliente già montato come da soluzione scelta. Di seguito troverete un esempio esplicativo di come ordinare un mobile appartenente alla soluzione D. Le soluzioni A e B possono essere utilizzate con lavabi a parete, con lavabi da terra, oppure possono essere inseriti singolarmente in spazi living.



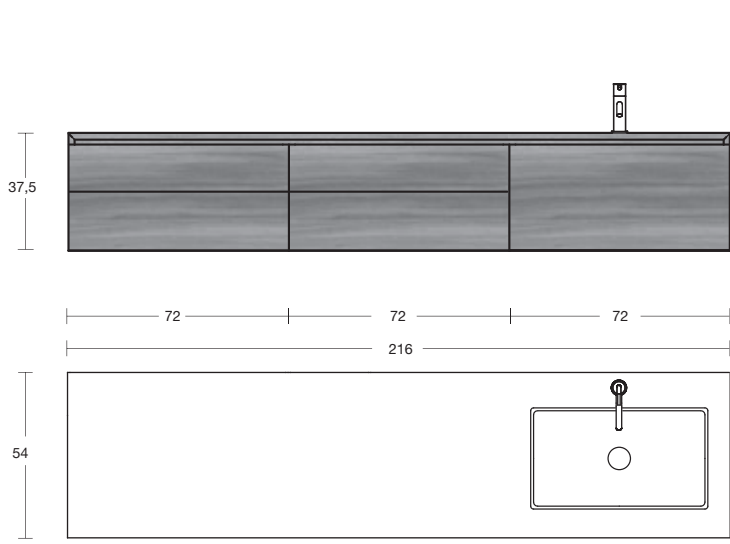

Specify at time of order the type of configuration among the proposed solutions (A,B,C,D,E,F,G) together with desired size of units and selected category. The modules will be assembled at the company and will be delivered to the client as per selected configuration. Find below an example of how to order one configuration belonging to solution D. Solution A and B are suitable for wall-mounted sinks, freestanding sinks or can be placed as an independent unit in a living room.

**ESEMPIO MOBILE DA ORDINARE | EXAMPLE OF CONFIGURATION TO ORDER**

**D SOLUZIONE | CONFIGURATION**

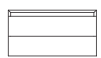

Versione dx - Right version

- 
 +
 
 N° 2 ART. PA4872 L 72  
 Base con 2 cassetti  
 Double drawer cabinet
- +
 
 ART. PI5472 L 72  
 Portalavabo con 1 cassetto  
 Sink unit with 1 drawer
- +
 
 ART. BC254 + ART. NIDO72 L 216  
 Top con lavabo integrato  
 Top with integrated sink
- +
 
 ART. AY301SA/AY301LU  
 Miscelatore monocomando  
 Single lever mixer

**SOLUZIONI LIVING | LIVING CABINETRY CONFIGURATIONS**

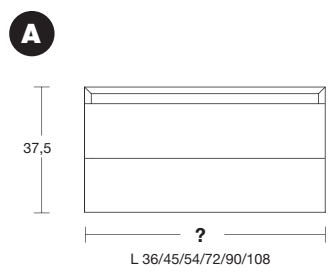

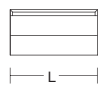
- Base con 2 cassetti  
 Double drawer cabinet
 

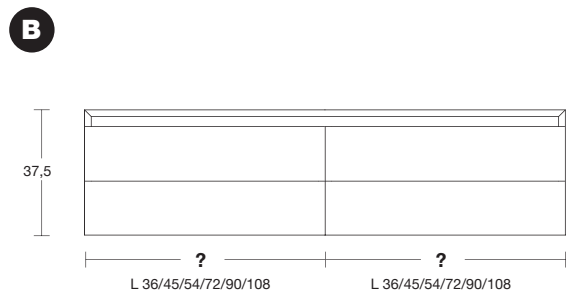

- Base con 2 cassetti  
 Double drawer cabinet
 
- +
 
- Base con 2 cassetti  
 Double drawer cabinet

SOLUZIONI CON PORTALAVABO | CONFIGURATIONS WITH SINK UNIT

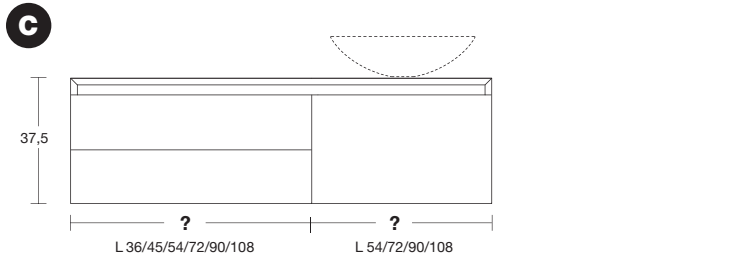

Base con 2 cassetti  
Double drawer cabinet

Portalavabo con 1 cassetto  
Sink unit with 1 drawer

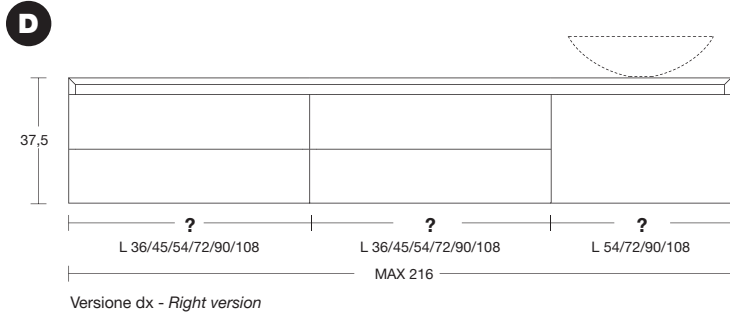

Base con 2 cassetti  
Double drawer cabinet

Base con 2 cassetti  
Double drawer cabinet

Portalavabo con 1 cassetto  
Sink unit with 1 drawer

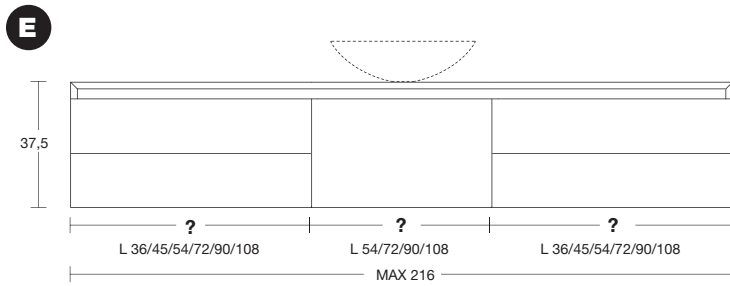

Base con 2 cassetti  
Double drawer cabinet

Portalavabo con 1 cassetto  
Sink unit with 1 drawer

Base con 2 cassetti  
Double drawer cabinet

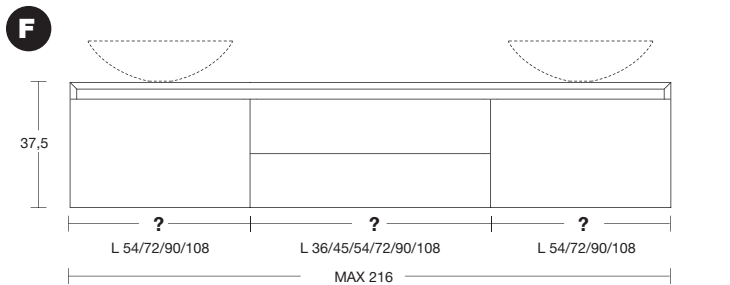
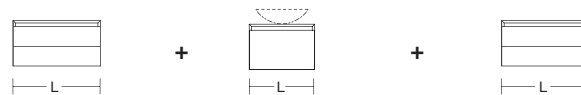

Portalavabo con 1 cassetto  
Sink unit with 1 drawer

Base con 2 cassetti  
Double drawer cabinet

Portalavabo con 1 cassetto  
Sink unit with 1 drawer

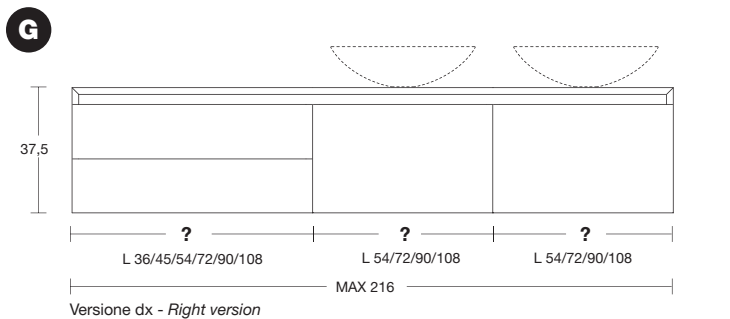

Base con 2 cassetti  
Double drawer cabinet

Portalavabo con 1 cassetto  
Sink unit with 1 drawer

Portalavabo con 1 cassetto  
Sink unit with 1 drawer

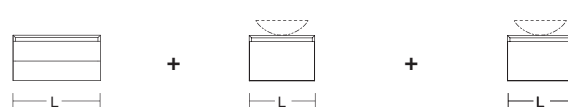

PANTA REI XL

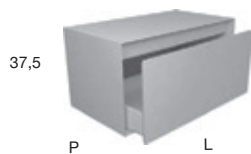

H	P	L
37,5	40	54 - 72 - 90 - 108
	47	
	54	

H	P	L
50	40	54 - 72 - 90 - 108
	47	
	54	

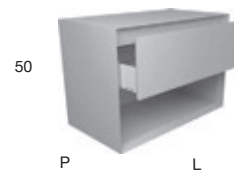

H	P	L
37,5	40	36 - 45 - 54 - 72 - 90 - 108
	47	
	54	

H	P	L
50	40	36 - 45 - 54 - 72 - 90 - 108
	47	
	54	

PANTA REI DOBLE

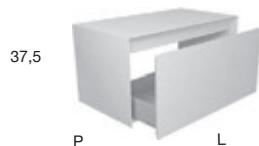

H	P	L
37,5	40	54 - 72 - 90 - 108
	47	
	54	

H	P	L
37,5	40	36 - 45 - 54 - 72 - 90 - 108
	47	
	54	

PANTA REI PENSILI E COLONNE - WALL CABINETS AND HIGH CABINETS

Pensile dx o sx con 1 anta e 2 ripiani interni.  
 Right or left single door wall cabinet with 2 internal shelves.

Pensile dx o sx con 1 anta e 2 ripiani interni.  
 Right or left single door wall cabinet with 2 internal shelves.



**H P L**  
 75 22 27 - 36 - 45

**H P L**  
 100 22 27 - 36 - 45

Colonna dx o sx con 1 anta e 3 ripiani interni.  
 Right or left single door high cabinet with 3 internal shelves.

Colonna dx o sx con 1 anta e 4 ripiani interni.  
 Right or left single door high cabinet with 4 internal shelves.

Colonna dx o sx con 1 anta e 4 ripiani interni.  
 Right or left single door high cabinet with 4 internal shelves.

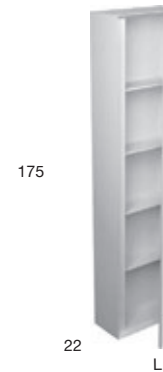

**H P L**  
 125 22 27 - 36 - 45

**H P L**  
 150 22 27 - 36 - 45

**H P L**  
 175 22 27 - 36 - 45

Colonna dx o sx con 1 anta, 3 ripiani interni e 1 cassetto Art. SLIM.  
 Right or left single door high cabinet, 3 internal shelves and 1 drawer Art. SLIM.

Colonna dx o sx con 2 ante e 4 ripiani interni.  
 Right or left double door high cabinet with 4 internal shelves.

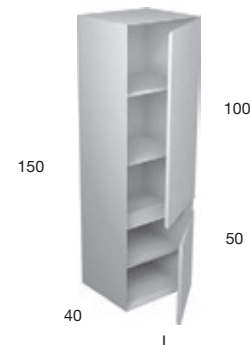

**H P L**  
 150 40 36 - 45

**H P L**  
 150 40 36 - 45

PENSILI | WALL CABINETS

COLONNE | HIGH CABINETS

PANTA REI