

COTTO D'ESTE
Nuove Superfici



QUICK START INSTALLATION MANUAL

What the system is comprised of

1 Silent

SOUNDPROOFING MAT

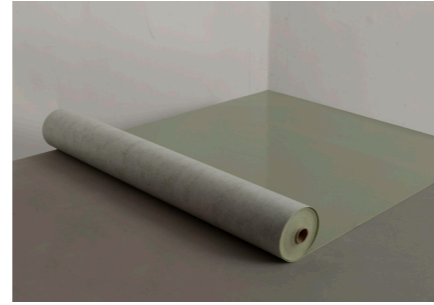

2

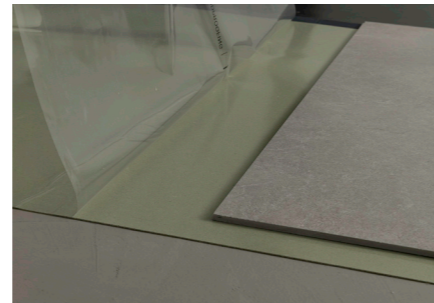

3 Filler

FINISHING SEALANT



Kerlite Easy offers two exclusive solutions for grout line finishes

FILLER FAST



The fastest and most practical to apply, for a floor that can immediately be walked on. Perfect for temporary locations or those that are renewed frequently (like exhibition stands or stores).

FILLER MATT



The best aesthetic performance thanks to its matte finish and minimal grout lines (starting at 1mm). Indicated for permanent locations, both in residential and commercial environments.

1 Kerlite

Laminated porcelain stoneware is characterized by the extraordinary dimensions of the slabs, which reach the sizes 100x300 cm and 120x278 cm, and by the reduced thickness, from 3.5 mm to 6.5 mm. The final product is light, resistant, versatile and easy to use. Laminated porcelain stoneware is a truly universal ceramic surface which is the fruit of Panariagroup's unrelenting research activity into beauty and technical excellence. It is ideal for numerous applications in the world of architecture and design and it is suitable for covering not only floors and walls, but also furniture, accessories, kitchens and countertops, ventilated façades and walls, tunnels and large public works.

For further information see Kerlite Technical Manual.

A complete range of over 140 articles

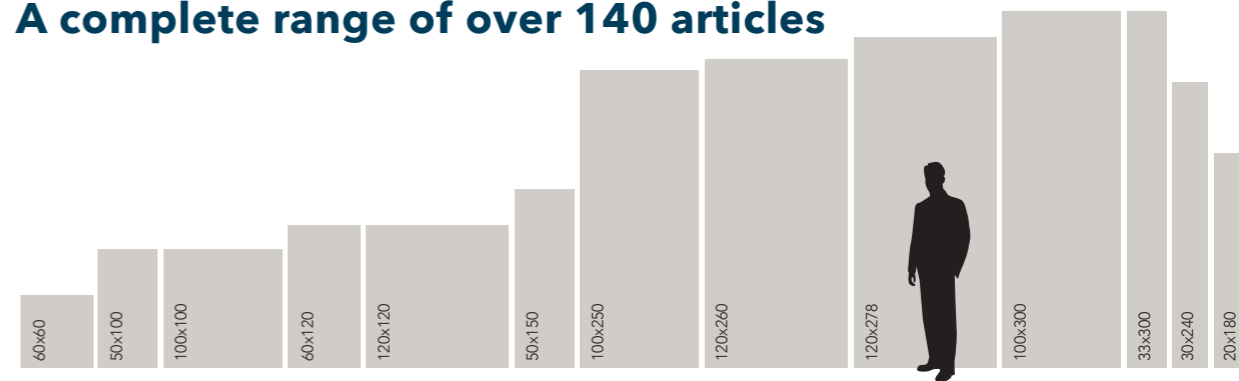

Ultrathin and ultrasensitive

Reinforced with fibreglass mesh on the reverse side

5plus
5,5mm
sizes up to
100x300 cm

6plus
6,5mm
sizes up to
120x278 cm

Kerlite Easy can be used only with 5plus and 6plus slabs in all available sizes except the 20x120 cm size. Products with special finishes can have limitations depending on their area of application. Refer to specific collection catalogues.

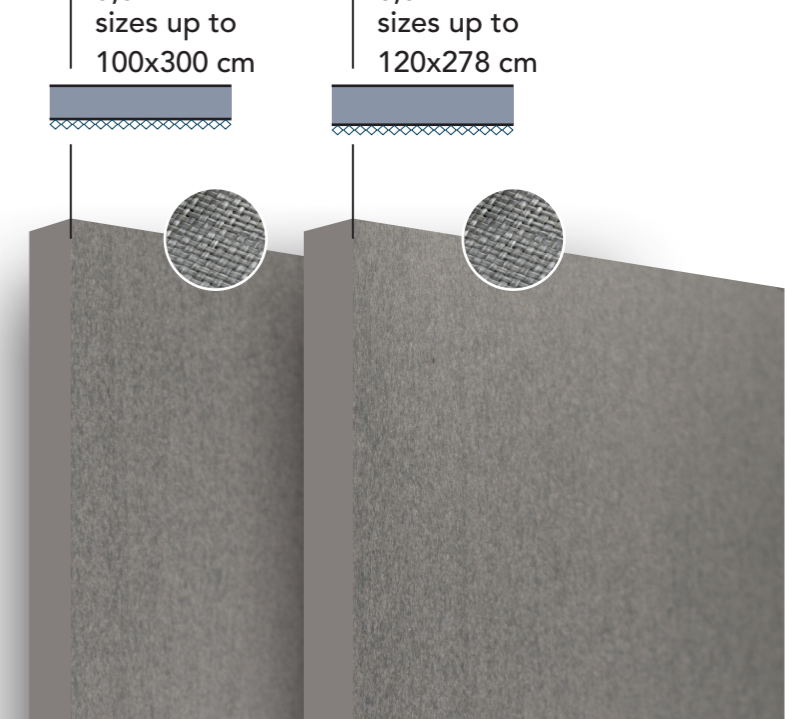

2

Silent

SOUNDPROOFING
MAT

What the system is comprised of

SILENT is a plant based polyurethane decoupling mat with inert fillers. It has outstanding thermal conductive properties and, when used with Kerlite, does an excellent job of reducing footfall noise as well.

It is a product without "memory": once laid it immediately moulds to the shape of the support onto which it has been installed and does not maintain the wavy shape created by having been packaged in rolls. This trait makes it possible to significantly reduce installation times.

SILENT ensures a substantial degree of surface grip, a characteristic that is fundamental to ensuring that Kerlite is laid properly. In fact, once a Kerlite slab has been laid, it adheres very well to the mat while still allowing for subsequent adjustments.

The superficial part of the mat is protected by a transparent plastic film. This has two benefits:

- 1) It preserves the characteristics of the mat over time;
- 2) It makes it possible to lay the mat and to take off the protective film a little at a time as one proceeds with installation, rather than to have to move around a mat that gets stuck to the soles of one's shoes.

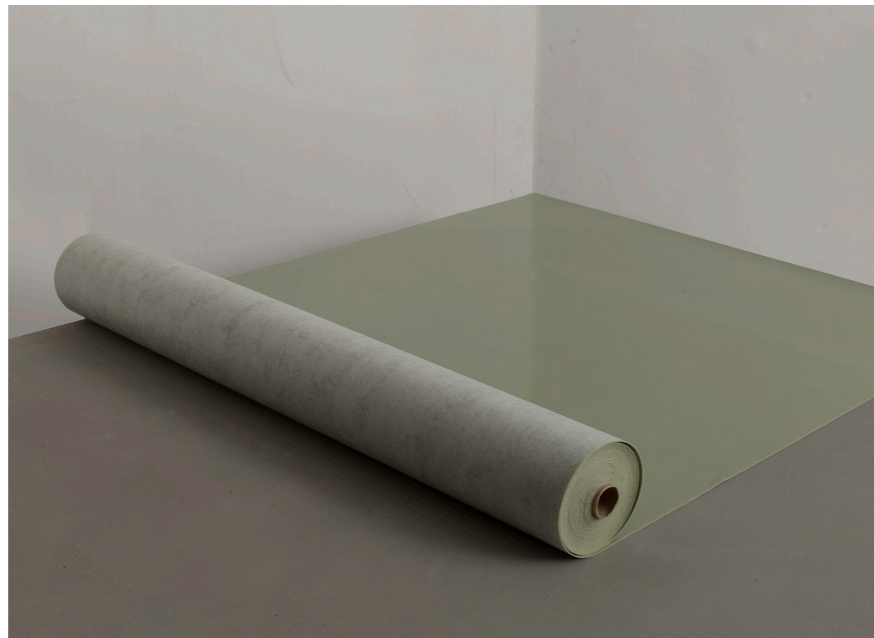

Primary Benefits

ACOUSTIC BENEFITS

The Kerlite Easy system is soundproofed thanks to the combined action of the SILENT mat and Kerlite. The system's soundproofing is equal to 17dB, which means that footfall noise transmitted to the lower floor is approximately 16 times less than that of a traditional ceramic floor laid using adhesives.

PRESERVES THE EXISTING FLOOR

The Kerlite Easy system is perfect for installation on heated/cooled floors.

ALLOWS FOR INSTALLATION WITHOUT JOINTS

Thanks to the use of the SILENT mat, the Kerlite Easy system can be installed without expansion joints even on critical surfaces like: mixed subfloors, under-floor heating systems, old ceramic subfloors, floors at constant risk of cracking, wooden supports, etc.

INSTALLATION ON HEATED/COOLED FLOORS

The Kerlite Easy system is perfect for installation on heated/cooled floors. That's because Kerlite and SILENT are two materials with excellent thermal-conductive characteristics which, when combined with their reduced thickness, make EASY the best solution for cladding a radiant floor.

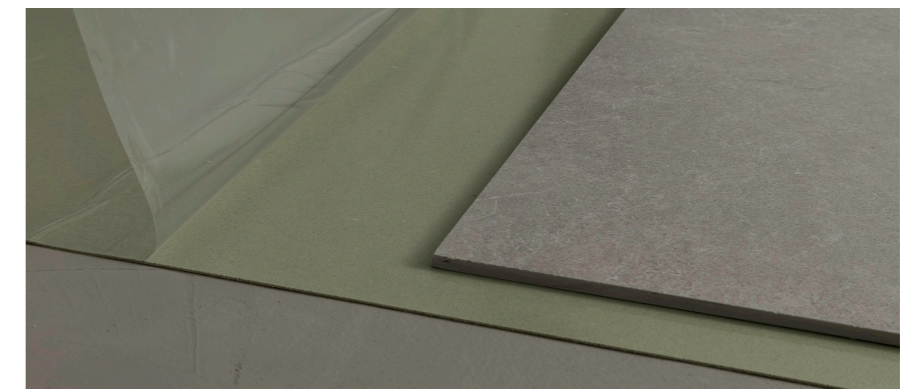

CAUTION

Before positioning the slabs, the mat's transparent protective film must be removed.

What the system is comprised of

3

Filler^{FAST}

FINISHING SEALANT

FILLER FAST is a highly flexible and mould resistant pure acetic silicone sealant, for movements of up to 25%.

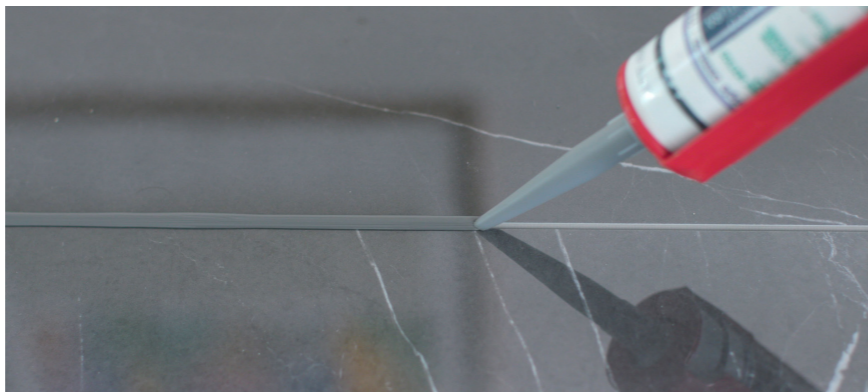

FILLER FAST, a one-component silicone sealant with solvent-free acetic reticulation, comes as a thixotropic paste that is easy to apply horizontally and reticulates with atmospheric moisture at room temperature, creating an elastic product with the following properties:

- outstanding durability; the seal remains unaltered even after being exposed for many years to adverse weather conditions, industrial atmospheres, sudden changes in temperature, and immersion in water;
- high elasticity; mould resistant pure acetic silicone sealant, free of solvents;
- outstanding adhesion on glass, ceramic, and anodised aluminium;
- mould resistant;
- impermeable to water and permeable to water vapour;
- resistant to chemical agents;
- flexible all the way down to -40°C and resistant to temperatures of +180°C;
- easy to work with;
- compliant with regulation ISO 11600, classified as F-25-LM;
- compliant with numerous international regulations;
- compliant with EN 15651-1, EN 15651-2, and EN 15651-3 and bears the CE seal.

Primary Benefits

STABLE

The fiberglass mesh on the rear side of the laminated porcelain stoneware slabs combined with the use of the SILENT mat and FILLER FAST sealant ensure the utmost durability and stability to the floor.

WATERPROOF

The combined use of laminated porcelain stoneware and FILLER FAST sealant guarantees that the floor is entirely waterproof.

MORE BEAUTIFUL

The combined use of laminated porcelain stoneware, SILENT, and FILLER FAST makes it possible to install a floor without expansion joints, which makes it more beautiful.

What the system is comprised of

3

Filler_{MATT}

FINISHING
SEALANT

FILLER MATT is a ready-to-use, single-component, water-based polymer filler that is highly elastic and resistant to mould.



FILLER MATT is a jointing agent dispersed in water and made with acrylic polyurethane resins loaded with mineral fillers and additives.

FILLER MATT is a ready-to-use paste with a consistency that makes it easy to apply.

FILLER MATT sets as the water evaporates, eventually achieving a plastic-like consistency and excellent adhesion, which is resistant to the vibrations and distortions of construction materials.

FILLER MATT can be used to fill grout lines measuring 1 mm to 8 mm thick.

FILLER MATT can be easily applied, removed, and cleaned from the surface of the tiles. Furthermore, once dry, it has a uniform colour, a smooth surface and is resistant to water and mould formation.

The technology used blocks the formation of the microorganisms responsible for mould.

Furthermore, its synergistic effect makes the grout lines waterproof and reduces the absorption of water on the surface.

Primary Benefits

STABLE

The fiberglass mesh on the rear side of the laminated porcelain stoneware slabs combined with the use of the SILENT mat and FILLER MATT sealant ensure the utmost durability and stability to the floor.

WATERPROOF

The combined use of laminated porcelain stoneware and FILLER MATT sealant guarantees that the floor is entirely waterproof.

MORE BEAUTIFUL

The combined use of laminated porcelain stoneware, SILENT, and FILLER MATT makes it possible to install a floor without expansion joints, which makes it more beautiful.

How to use the Kerlite Easy system efficiently

The installation of Kerlite with the KERLITE EASY system includes all the phases starting from the design that lead to the final result. These activities are essentially the following:

- 1 **PROJECT AND SUBSTRATE ANALYSIS AND PLANNING**
Starting from the project design, the installer prepares and agrees with the client/project supervisor a schedule for the various installation phases. This schedule must take into account the time requirements of the various phases, as well as the timing for the curing required by certain materials (e.g. adhesives and levelling products).

It is the installer's responsibility to formally point out to the client any inconsistencies between the design and the actual installation.
- 2 **MONITORING OF ENVIRONMENTAL CONDITIONS**
The working environment temperature must be between 5°C and 50°C to guarantee the proper application of the FILLER sealant.
- 3 **HANDLING, STORAGE AND CHECKING MATERIALS**
On arrival at the construction site, the materials must be checked and stored. The installer must promptly and formally highlight any obvious defects. Defective materials must not be installed unless a formal written order has been received from the customer.
- 4 **LAYING OF THE MAT, INSTALLATION AND CUTTING OF KERLITE**
For the laying of the mat and the cutting of Kerlite please refer to the dedicated technical sheet. For more info about Kerlite application please refer to the Kerlite technical manual.

5 **PREPARATION AND APPLICATION OF GROUTING JOINTS AND EXPANSION JOINTS**

For preparation and application of grouting and expansion joints refer to the dedicated technical sheet.

6 **POST-INSTALLATION CLEANING AND PROTECTION**

It is the installer's responsibility to deliver the tiling clean in its entirety. After cleaning, the installer must also take care of protecting the tiling (with suitable systems) until its delivery to the client.

7 **TESTING**

The testing of tiling consists in the process of verifying the quality of the tiling itself. Testing is the responsibility of the client, and must be carried out before it is ready for use, in the presence of the designer and the installer.

The client is entitled to draw up an acceptance report at the end of the testing period.

8 **MAINTENANCE**

The maintenance of the tiling to be carried out on laminated porcelain stoneware only includes cleaning operations. For cleaning methods refer to Kerlite technical manual.

For further information about the individual components please consult the technical data sheets.

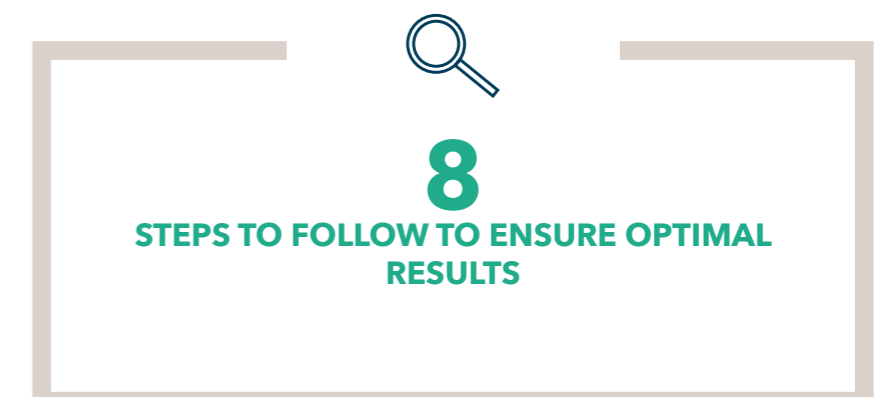

Project Analysis: Suggestions for creating a laying plan.

In order for the KERLITE EASY system to function properly, and to obtain the best aesthetic result, we recommend conducting a survey of the space before starting work and subsequently creating a laying plan which will be executed.

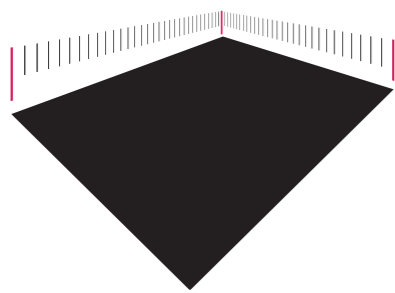

1 Measure the project room.

2 Note the size of the slabs which will be used

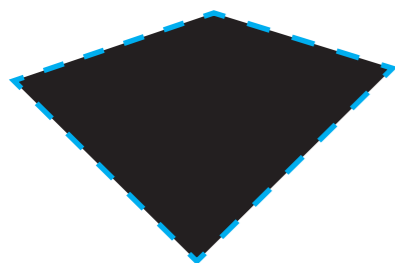

3 Consider an outer joint of approximately 5/8 mm

4 Take into account the size of the grout lines when calculating the surface required, remembering that these will be at least 2 mm thick using FILLER FAST and at least 1 mm thick using FILLER MATT.

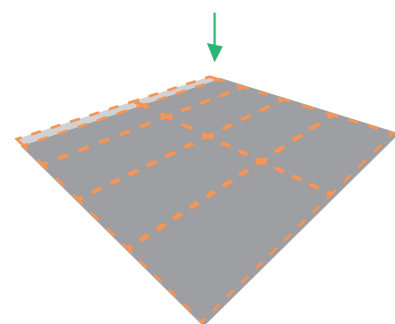
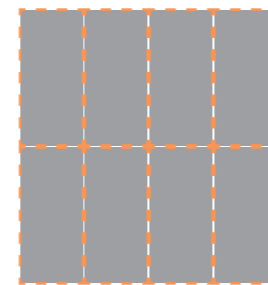

5 Verify whether or not it will be necessary to cut the slabs.

If the slab must be cut to less than half of its original size, trim the edges.

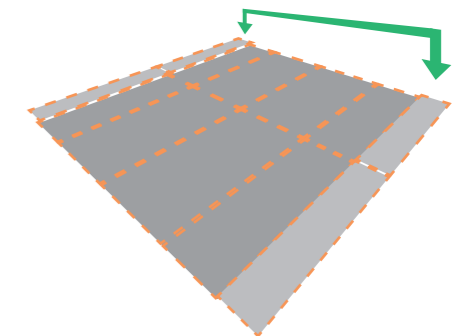
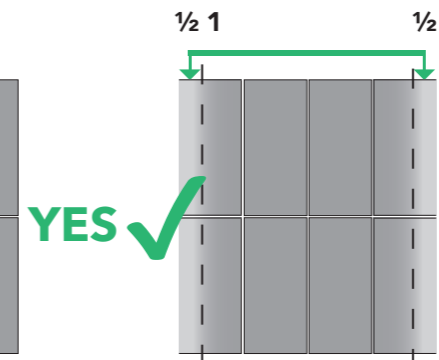
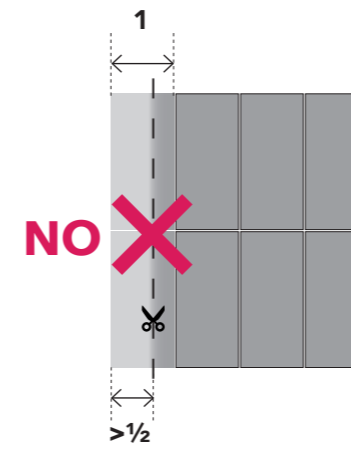
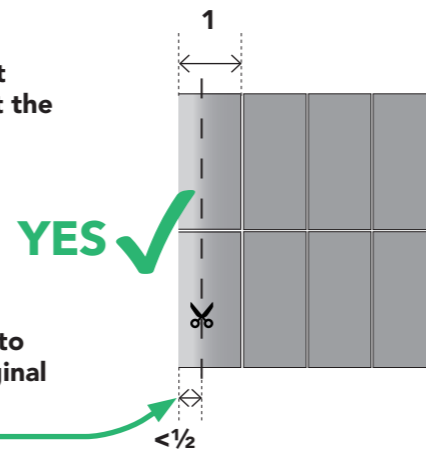

However, if the slab must be cut to less than half of its original size, then proceed by splitting the cut between the two sides of the space.

It is a good practice to establish the laying plan starting from the position of the doors in order to visually present a full slab as soon as one enters the room. However this kind of attention to detail may result in a greater number of outer cuts. Remember that it is a priority to always use slabs that have not been cut, in their short side, to less than 50% of their original size.

Do not worry if you have nearly completed installation and then realise that the slabs could have been distributed better: another advantage of Kerlite Easy is the ease with which the slabs can be repositioned. That is why we suggest creating a laying plan, then laying the slabs, and, only when certain of the result, proceeding with the necessary cuts.

FOR AN OUTSTANDING AESTHETIC RESULT, FINISH THE FLOORING WITH SLABS CUT TO NO MORE THAN 50% OF THEIR ORIGINAL SIZE ON THE SHORT SIDE.

Analysis of Substrate

Kerlite cladding with the KERLITE EASY system can be installed on any type of floor substrate as long as its design and construction has taken into account the necessary project requirements and respects current regulations.

Characteristics of the support

The substrate on which the product will be installed must have the characteristics detailed below. The assurance and the verification of these characteristics is the responsibility of the individual who designs and completes the project.

IMPORTANT

The Kerlite Easy system is a decoupled system, therefore it can also be used on supports that are not perfectly COMPACT (in terms of surface and thickness) or INTACT.

CLEAN

The surface of the support must be clean and free of impurities (for example cement slurry, penetrating oils, or traces/residue of paints, adhesives, etc.). In the event that these are present, it is necessary to remove them with the appropriate products and methods.

STABLE AND DRY

The support must be stable and superficially dry. If the instructions of the producer of the screed are respected and if the rules of good building practice have been followed, then it is not necessary to test for residual moisture. If you wish to conduct the tests anyway, then you must remember that the mass of the residual moisture is determined through a measurement taken with a carbide hygrometer. Throughout the thickness of the substrate and for all measurements made, at least one for each room, the maximum percentage allowed must be:

- 3% for CT class screeds (cement based and special binding agents);
- 0.5% (0.3% in the case of substrates with radiant heating and cooling) for class CA screeds (based on calcium sulphate / anhydrite).

WARPAGE

Flatness of the support is checked by using a levelling rod with a length of at least 2 metres. Place the rod on the substrate in all directions. The permissible tolerance is 2 mm. If the surface does not meet the specified requirements, a levelling layer is required.

Analysis of the substrate: what to do if it is not flat?

If the substrate is not flat as indicated previously one must use adequate surface levelling products. Apart from the standard "wet" levelling solutions, with Kerlite Easy one can also use "dry" levelling solutions. This second method is only possible with Kerlite Easy.

Dry levelling system

The dry levelling system consists in laying compact plastic sheets to compensate for any differences in the surface level.

The sheets especially in the A4 size and with a thickness of 0.15mm are easily found in stationaries.

BEFORE INSTALLATION

If while checking the substrate issues are found in the flatness of the surface, they can be corrected by spreading where necessary the plastic sheets so as to obtain a flat substrate. Once the substrate is flat proceed with the laying of the mat.

DURING AND AFTER INSTALLATION

The "dry" levelling system is simple and it is also possible to correct issues regarding the flatness of the surface even AFTER Kerlite has been laid.

- 1) Remove the Kerlite Slab.
- 2) With a levelling rod or even simply a portion of a Kerlite slab one can check for flatness.
- 3) Add the plastic sheets so as to compensate and flatten out the surface.
- 4) Lay back the Kerlite slab.

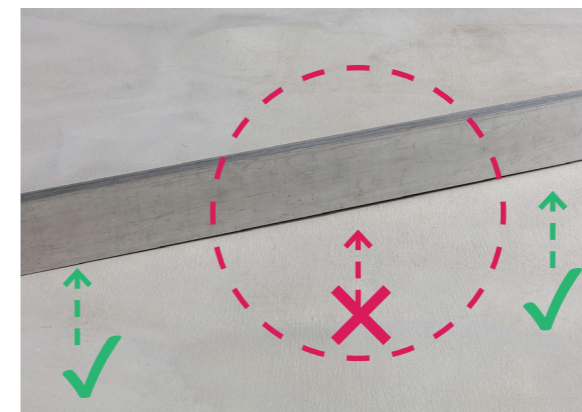
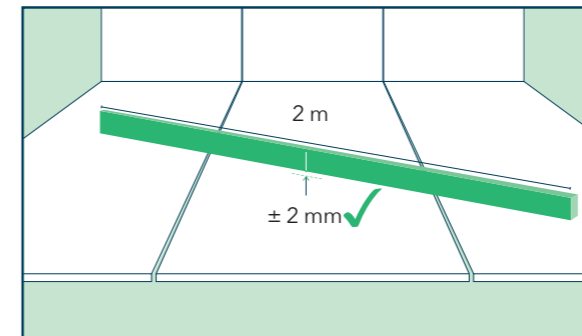



Planning the Work: the Required Tools



For installation of the system, the following tools are required:

- 1) Manual tile cutter / tools for working with Kerlite
- 2) Cutter
- 3) Pencil
- 4) A ream of plastic sheets, size A4, preferably with a thickness of 0.15 mm, for correcting any potential unevenness in the support.

with FILLER FAST	with FILLER MATT
5) 2mm spacers	5) 1mm spacers
6) Spray bottle	6) a rubber trowel or rubber squeegee
7) Solution of water and dish soap (10 to 1 ratio)	7) a hard cellulose sponge
	8) Rinse the sponge frequently using two different containers of water; one to remove the excess mixture and one filled with clean water for rinsing.





Handling and Storage of the Materials

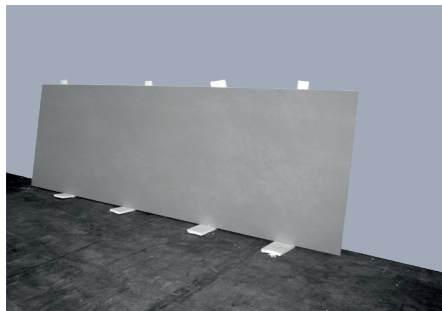

For manual handling, package handling, and storage of Kerlite, please refer to the Kerlite Technical Manual.

Silent

SOUNDPROOFING MAT



SILENT does not require specific precautions, but must be stored away from atmospheric agents. The individual rolls can be stored either vertically or horizontally and must not be stacked one on top of the other. When there are 40 rolls, these are packed into boxes and put on standard 80x120 pallets. No more than two boxes can be stacked on top of one another. Each box contains 40 rolls for a total of 400 sqm of matting and a total of 600 kg (plus the weight of the box and the pallet).

Filler

FINISHING SEALANT

FILLER FAST



FILLER FAST must be stored in a cool dry place in its original cartridge for no more than 24 months.

FILLER FAST comes in 310 ml cartridges.

FILLER MATT



FILLER MATT must be stored in its original packaging in a dry place and at a temperature between +5°C and +30°C, for a maximum duration of 24 months in its perfectly sealed packaging.

FILLER MATT is available in 5 kg plastic drums.



Control of materials

Checking the materials

The installer must check the materials before using them and must formally inform the client of any obvious defects promptly. Defective materials must not be installed unless a formal written order has been received from the customer.

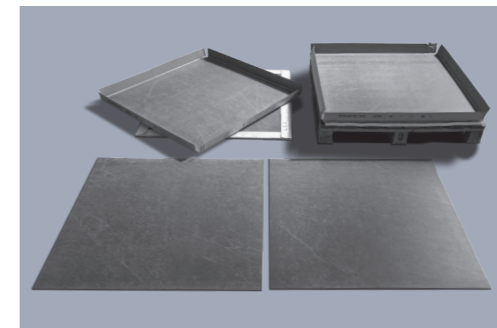

Silent

SOUNDPROOFING MAT

easy FLOATING FLOOR SYSTEM	Silent SOUNDPROOFING MAT MATERASSINO FONDOASSORBENTE
<p>Technical data sheet Dati tecnici materassino</p> <p>1m x 10m</p> <p>10 m²</p> <p>1,5mm</p> <p>15kg (1,5kg/m²)</p> <p>Bfl-s1</p> <p>ΔLw=17dB</p> <p>0,01 m² R/W</p>	<p>Technical data sheet Dati tecnici materassino</p> <p>1m x 10m</p> <p>10 m²</p> <p>1,5mm</p> <p>15kg (1,5kg/m²)</p> <p>Bfl-s1</p> <p>ΔLw=17dB</p> <p>0,01 m² R/W</p>

Filler

FINISHING SEALANT

FAST	FAST
<p>GRIGIO CEMENTO - CONCRETE GRAY</p> <p>PURE SILICONE ACETIC FOR CERAMIC</p> <p>REINER ACETAT SILICONACHTSTOFF FÜR KERAMIK</p> <p>SILICONE ACETIQUE PUR POUR CERAMIQUE</p> <p>SILICONA ACETICA PURA PER LA CERAMICA</p> <p>310 ml</p>	<p>GRIGIO CEMENTO - CONCRETE GRAY</p> <p>PURE SILICONE ACETIC FOR CERAMIC</p> <p>REINER ACETAT SILICONACHTSTOFF FÜR KERAMIK</p> <p>SILICONE ACETIQUE PUR POUR CERAMIQUE</p> <p>SILICONA ACETICA PURA PER LA CERAMICA</p> <p>5 kg</p>

MATT	MATT
<p>GRIGIO MIELO MEDIUM GRAY</p> <p>STUCCO DI FINITURA</p> <p>FINISHING SEALANT</p> <p>310 ml</p>	<p>GRIGIO MIELO MEDIUM GRAY</p> <p>STUCCO DI FINITURA</p> <p>FINISHING SEALANT</p> <p>5 kg</p>

Laying of the Mat, Installing and Cutting Kerlite

Laying of SILENT Mat

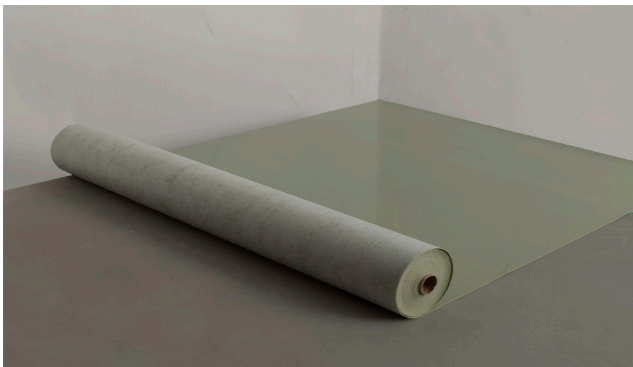

Lay the mat starting from the corner of the space.

Cut to size.

Position the Kerlite Slabs

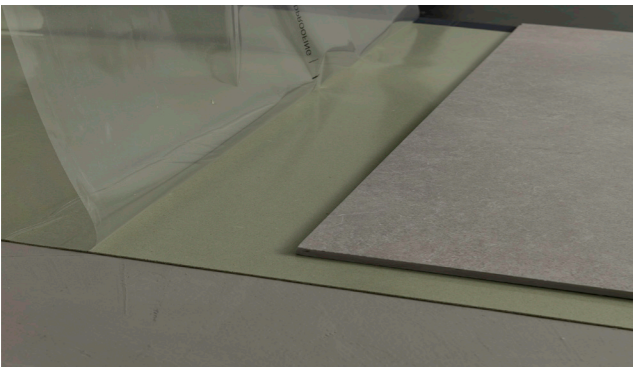

DO NOT remove completely the protective film. The film must be removed gradually while the Kerlite slabs are being laid.

Lay the Kerlite slabs, using spacers to distance them from each other. The spacers will not be removed, but rather covered by the grout so be sure to push them down as far as possible.

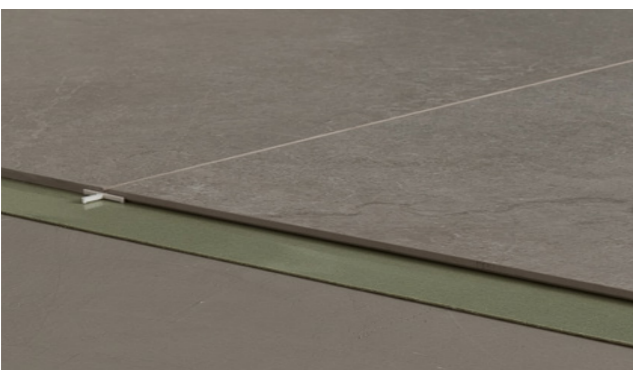

Cut to size. Around the perimeter of the room, maintain a distance from the walls of approximately 5mm. This outer joint will then be covered by the skirting or can be filled with silicone like a normal grout line.

KERLITE EASY MUST BE LAID EXCLUSIVELY WITH A CONTINUOUS GROUT LINE, WITH THE EXCEPTION OF THE 20X180 CM, 30X240 CM, AND 33X300 CM SLATS, WHICH CAN BE LAID WITH A STAGGERED GROUT LINE.

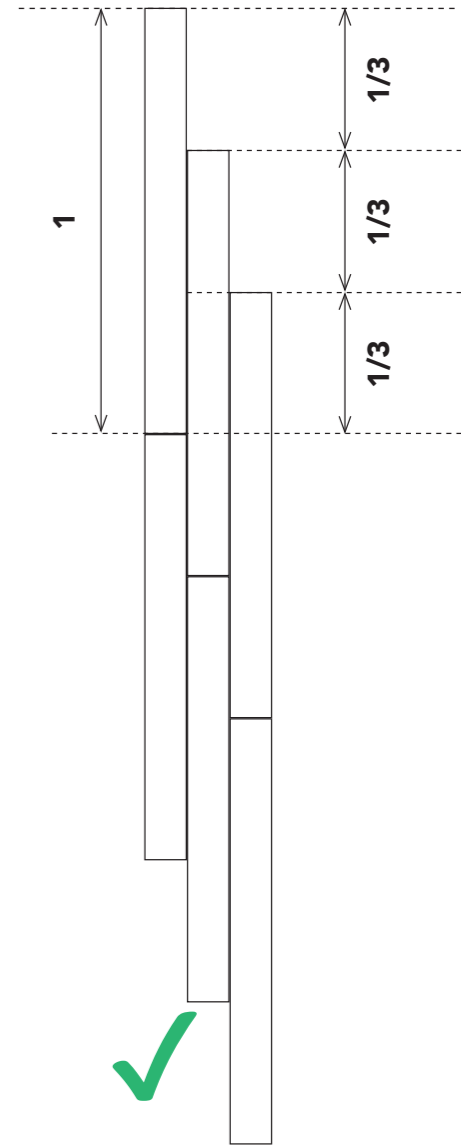
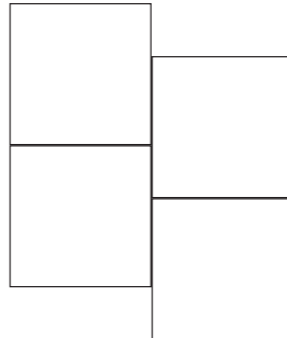
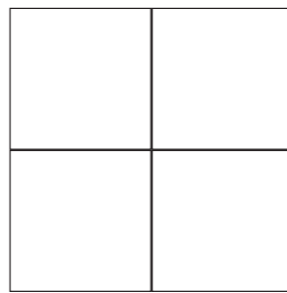

Cutting Kerlite Slabs

For information regarding the cutting of the slabs refer to the instructions in the Kerlite Technical Manual. It is important to note that L-shaped slabs and slabs with holes drilled through cannot be used with Kerlite Easy.

Filler_{FAST}

FINISHING
SEALANT

Grouting

Grout Lines and Expansion Joints

GROUT LINES

So-called "zero grout line" installation is not recommended.

The minimum size of the grout lines is 2 mm.

The grouting and cleaning of the surface of laminated porcelain stoneware from residues of installation materials must be carried out in parallel and always following the instructions of the grout manufacturer, so that, at the end of grouting, the tiling is finished and clean.

INTERMEDIATE, EXPANSION AND PERIMETER JOINTS

The use of KERLITE EASY does NOT require structural and expansion joints.

Meanwhile, outer joints, in correspondence with fixed elements in the bearing structure, must be placed along the perimeter of the tiling and must measure approximately 5-8 mm.

This outer joint can be covered with skirting or filled with silicone like a normal grout line.

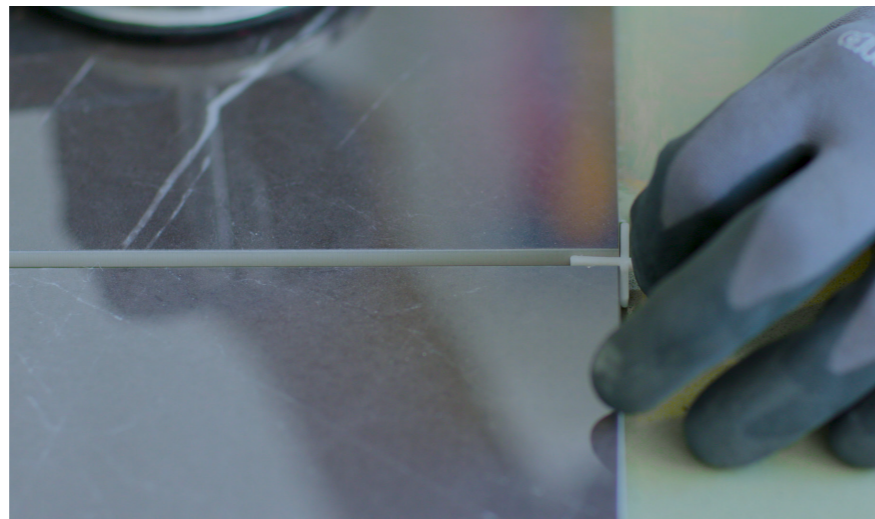

The use of 2mm spacers, which can be easily purchased, makes it possible and very simple to create uniform grout lines. The spacers will not be removed, but will rather be covered by the grout, so be sure to push them far enough down.

FILLER FAST Grouting

FILLER FAST is an acetic silicone that comes in cartridges, created to fill the grout lines of the KERLITE EASY system.

FILLER FAST serves two functions:

- 1) It makes the floor waterproof by sealing the Kerlite slabs;
- 2) It serves as an expansion joint thanks to its elasticity.

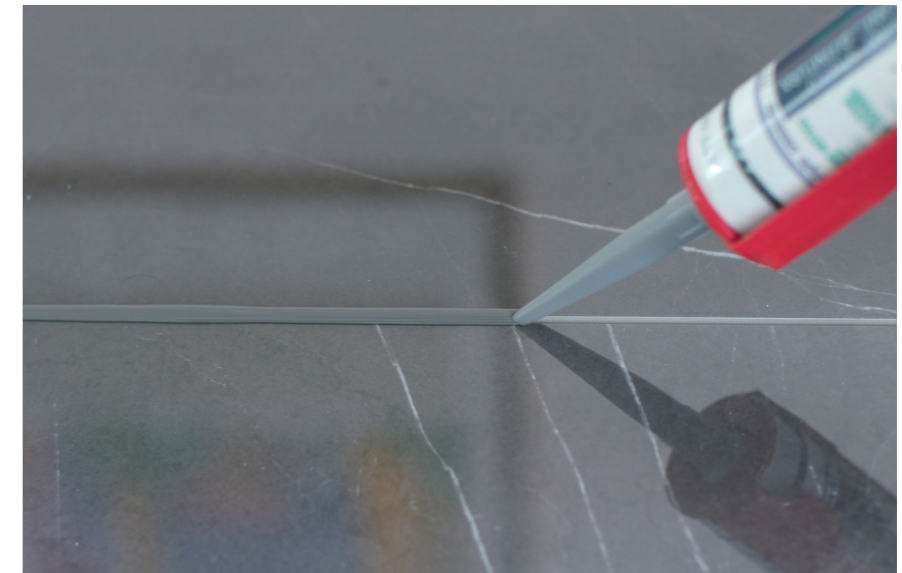

- 1 In order to apply the silicone, in cartridges, a silicone gun is required. The fluidity of the silicone makes it appropriate for use with either a manual silicone gun, more common and less expensive, or an electric gun, which is certainly more convenient when filling the grout lines of a large floor.

FILLER FAST comes in 310 ml cartridges. To use cut the cartridge at the top of its thread. For grout lines of 2 mm, it is not necessary to cut the cartridge at the top of its thread; just screw on the nozzle, insert the cartridge in the gun, and extrude.

Filler_{FAST}

FINISHING
SEALANT

Grouting

REMOVING EXCESS SILICONE

The removal of the silicone **MUST** be done within 10 minutes of application so as to avoid hardening of the superficial part.

To remove partially reticulated FILLER FAST from tools and surfaces, you can use common solvents (ethyl acetate, petrol, toluene).

After it is fully reticulated, the silicone can only be removed mechanically.

When exposed to air, FILLER FAST reticulates and becomes elastic due to the effect of the moisture in the air. The speed of its reticulation depends very little on temperature and is, instead, primarily dependent on the atmospheric moisture present. The reticulation process at +23°C and 50% atmospheric moisture will take 10-12 hours to fully harden.

NECESSARY TOOLS

Two tools are necessary for removing excess silicone:

- 1) A spray bottle containing a solution of water and dish soap in a 10 to 1 ratio;
 - 2) An empty cartridge of silicone used for the grouting.
- Remember to remove any residual silicone from the empty cartridge that may ooze out of the nozzle so as to avoid having this potentially drip onto the floor.

NOTE: with grout lines of 2mm, a cartridge will be used up after approximately 8 linear meters, therefore within the 10 minute time limit for cleaning the excess silicone.



THANKS TO KERLITE EASY IT IS NOT NECESSARY TO CREATE STRUCTURAL OR EXPANSION JOINTS.



2

Using the spray bottle, thoroughly spray the part of the grout line that is to be cleaned. Spray the rear extremity of the cartridge which will be used to pick up the excess silicone. Rest the cartridge against the grout line and scrape up the excess silicone. The excess silicone will remain inside the cartridge. Continue in this manner for the entire cleaning of the grouted area.



IMPORTANT:

Before wiping up the excess silicone, spray the soap and water solution onto the floor area and onto the nozzle of the empty cartridge each time. If small crests or imperfections appear in the remaining silicone, spray some of the solution onto that area and onto your fingers.

Then trace over the grout line with a finger.

Also In this case, remember to first spray the soap and water solution.



LIGHT FOOT TRAFFIC AND READY TO USE

The EASY system with FILLER FAST grout is set for light foot traffic after approximately 24 hours and is ready for use after approximately 7 days (calculated on the basis of +23°C and 50% atmospheric moisture).

WHEN THE SILICONE IS DRY, THOROUGHLY WASH THE FLOOR

Thoroughly wash and dry the floor.

The removal of the excess silicone leaves behind a significant amount of soap and water, which may look like streaks along the grout lines. A thorough washing will make the floor look perfect. Do not walk on the silicone before it is completely dry (approximately 12-18 hours, depending on the climatic conditions).

Grouting

Filler MATT FINISHING SEALANT

Grout Lines and Expansion Joints

GROUT LINES

So-called "zero grout line" installation is not recommended. The minimum size of the grout lines is 1 mm.
The grouting and cleaning of the surface of laminated porcelain stoneware from residues of installation materials must be carried out in parallel and always following the instructions of the grout manufacturer, so that, at the end of grouting, the tiling is finished and clean.

INTERMEDIATE, EXPANSION, AND PERIMETER JOINTS

The use of KERLITE EASY makes structural and expansion joints NOT necessary.
Meanwhile, perimeter joints, in correspondence with fixed elements in the bearing structure, must be placed along the perimeter of the tiling and must measure approximately 5-8 mm. This perimeter joint can be covered with skirting or filled with silicone like a normal grout line.

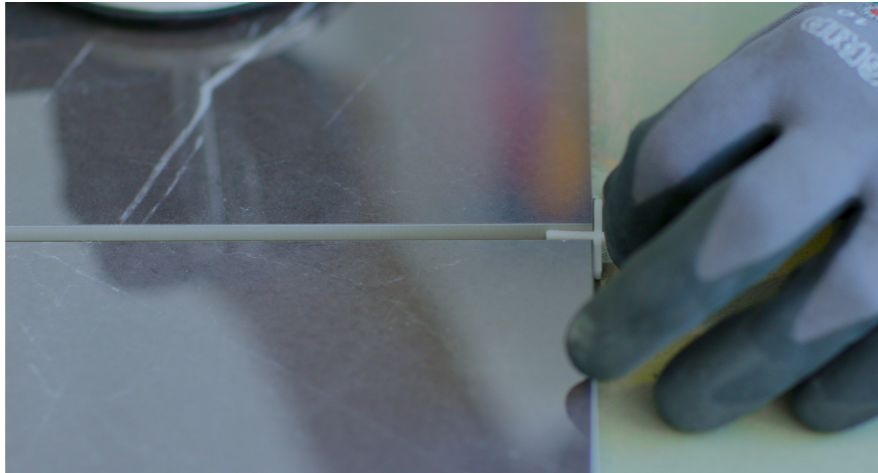

The use of 1mm spacers, which can be easily purchased, makes it possible and very simple to create uniform grout lines.
The spacers will not be removed, but will rather be covered by the grout, so be sure to push them far enough down.

FILLER MATT Grouting

FILLER MATT is a ready-to-use, single-component, water-based polymer filler designed to be used to fill the grout lines of the KERLITE EASY system.
FILLER MATT serves two functions:
1) It makes the floor waterproof by sealing the Kerlite slabs;
2) It serves as an expansion joint thanks to its elasticity.



- 1) Fill the joints using a rubber trowel or a rubber squeegee, leaving no gaps or unevenness and a smooth surface.

FILLER MATT is available in 5 kg plastic drums.

Filler_{MATT}

FINISHING
SEALANT

Grouting

REMOVING EXCESS FILLER AND THE TOOLS NECESSARY

Immediately remove excess FILLER MATT from the surfaces, while the product is fresh, by moving the spatula or squeegee diagonally to the joints.

10-15 minutes after application, depending on the temperature, and in any case when the product begins to form a light surface skin, remove the residue of FILLER MATT with a slightly damp hard cellulose sponge, working diagonally across the joints. Rinse the sponge frequently using two different containers of water; one to remove the excess mixture and one filled with clean water for rinsing.

Any streaks can be removed after at least 24 hours with a cleaner such as Kerapoxy Cleaner.

Spread the pure product on the surface and after just a few minutes rub it with a white Scotch-Brite® felt, rinse with a damp sponge, and dry with a clean cloth. It is not recommended to leave it in contact with the grout for more than 5 minutes.

When cleaning is finished, the product can be walked upon after approximately 24 hours and can be put into service after approximately 7 days.



LIGHT FOOT TRAFFIC AND READY TO USE

The EASY system with FILLER MATT grout is set for light foot traffic after approximately 24 hours and is ready for use after approximately 7 days (calculated on the basis of +23°C and 50% atmospheric moisture).

WHEN FILLER MATT IS DRY, THOROUGHLY WASH THE FLOOR

Thoroughly wash and dry the floor.

Do not walk on the filler before the appropriate amount of time has passed.

Cleaning and Protection

Post-installation cleaning

The installer must also provide clean tiling for any acceptance tests. The "post installation" cleaning serves to remove residual grout and is absolutely mandatory upon completion of the project. Non-slip surfaces: due to their particular, non-slip, rough or structured textures, are more difficult to clean. Therefore, we recommend paying particular attention to cleaning methods, specifically by intervening rapidly. Remember that the removal of the silicone must absolutely be done within 10 minutes of application so as to avoid hardening of the superficial part. To remove partially reticulated FILLER from tools and surfaces, one can use common solvents (ethyl acetate, petrol, toluene). After it is fully reticulated, the silicone can only be removed mechanically.

Protection

It is the installer's responsibility to protect the finished, clean tiling.

The protection of the ceramic covering for the period between the end of the installation and delivery to the client is all the more important when the environment in question will be subjected to significant foot traffic from other building operators (painters, electricians, bricklayers, etc..).

The protection of the slabs is carried out by applying suitable protective materials.

To avoid the formation of condensation which would cause problems with FILLER's reticulation, do not cover the freshly grouted surface with sheets or other materials.

For **FILLER FAST** wait at least 10-12 hours depending on the temperature before protecting the surface.

For **FILLER MATT** wait at least 48-72 hours depending on the temperature before protecting the surface.



IMPORTANT

The information and suggestions given in this manual are to be considered valid until the publication of a new one most recent update.

The new update cancels all of the above.

You can check for new ones updates on the website or by contacting the technical service company.

The company reserves the right to make, if deemed it appropriate, technical and formal changes to what illustrated in this publication.

APRIL 2021 EDITION

CERTIFICATIONS



Cotto d'Este guarantees for 10 years the resistance to wear of Kerlite ceramic slabs, the integrity of the Silent matting, and the functional characteristics of the Filler sealant, if installed in interior environments for residential or light commercial use.



Discover more:
www.cottodeste.it

COTTO D'ESTE[®] | LA
Nuove Superfici | BELLEZZA
IN
CERAMICA

Via Emilia Romagna, 31
41049 Sassuolo (MO) Italy
Tel +39 0536 814 911 - Fax +39 0536 814 921
cottodeste.it - info@cottodeste.it

PANARIAGROUP INDUSTRIE CERAMICHE S.p.A.

Seguici su:

