



**SHADE**



Ceramica  
VOGUE

TILES FOR ARCHITECTURE



# SHADE

La collezione SHADE 50, composta da 14 “sfumature” di colore, nasce dalla ricerca dei nostri laboratori interni, con la volontà di proporre nuove tonalità di colori in linea con le attuali esigenze cromatiche e progettuali. Realizzata in grès smaltato in pasta bianca, ingelivo, adatta per un impiego sia a pavimento che a rivestimento, viene proposta nel formato 50x50 cm rettificato. Nello spirito di proposta progettuale, che da sempre contraddistingue Ceramica Vogue, in abbinamento ai 14 colori di fondo, si aggiunge SHADE CUT, 7 formati declinati in tutti i colori, ricavati per incisione, che arricchiscono le superfici con piacevoli geometrie decorative.

Completano la collezione:

SHADE STICK, decorazioni a listelli ottenute per taglio del prodotto di fondo e montate su rete, formato 10x50 cm;

SHADE PROFILE, profili in alluminio brillantato.

*The SHADE 50 collection, made up of 14 colour “shades”, is the result of our in-house laboratory research aimed to offer new colour shades in line with current colour and design needs. Made in frost resistant white body glazed stoneware, it is suitable for both floors and walls, and is provided in the rectified size 50x50 cm. In the spirit of the design innovation that has always distinguished Ceramica Vogue, the 14 base colours are accompanied by SHADE CUT, 7 etched formats made in all colours that enhance surfaces with pleasing decorative geometries.*

*2 accessory families complete the collection:*

*SHADE STICK, stick decorations obtained by cutting the base product and mount on mesh, 10x50 cm size;*

*SHADE PROFILE, profiles in glossy aluminium.*







Pagina precedente/Previous page

Rivestimento/Wall:  
C1/C2/C3/C7/C6 SH 004 50x50x1 cm

Giunto/Joint:  
Mapei 143 Terracotta

Pavimento/Floor:  
GP 023 50x50x1 cm

Rivestimento/Wall:  
C2/C5 SH 002 50x50x1 cm

Giunto/Joint:  
Mapei 170 Crocus Blue



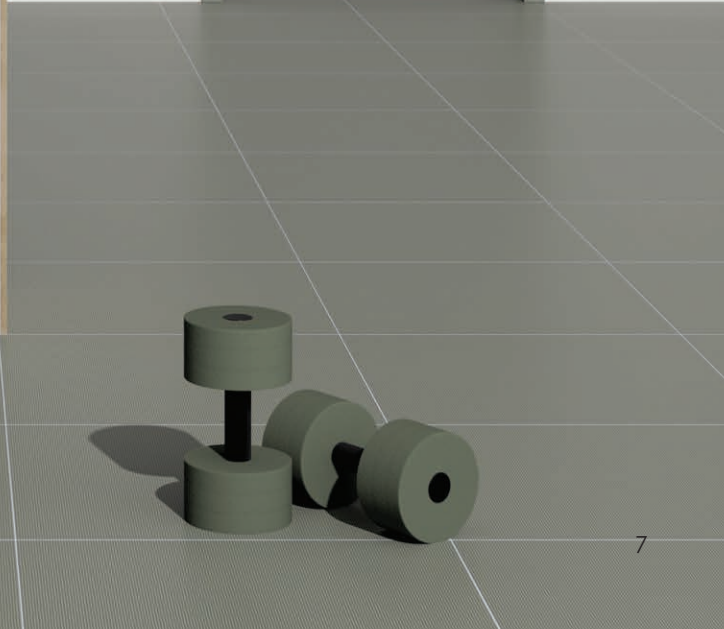





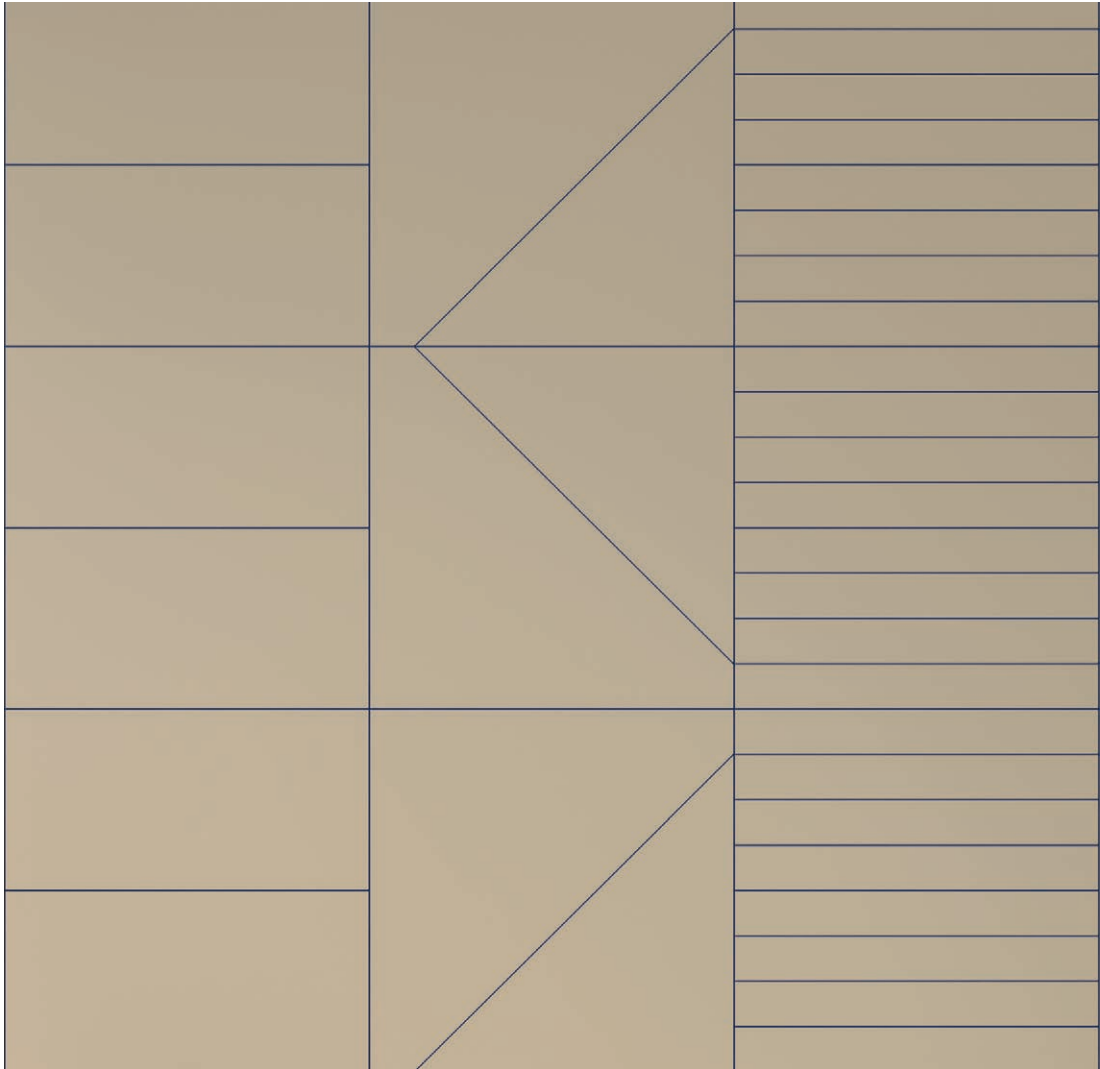

Pagina precedente/Previous page

Rivestimento/Wall:  
C1/C2/C3/C5/C6/C7 SH 003 50x50x1 cm

Giunto/Joint:  
Mapei 283 Sea Blu

Pavimento/Floor:  
SH 001 50x50x1 cm

Rivestimento/Wall:  
C1/C4/C7 SH 014 50x50x1 cm

Giunto/Joint:  
Mapei 170 Crocus Blue







Pavimento/Floor:  
SH 002 50x50x1 cm

Rivestimento/Wall:  
C1/C2/C6 SH 008 50x50x1 cm

Giunto/Joint:  
Mapei 115 River Grey

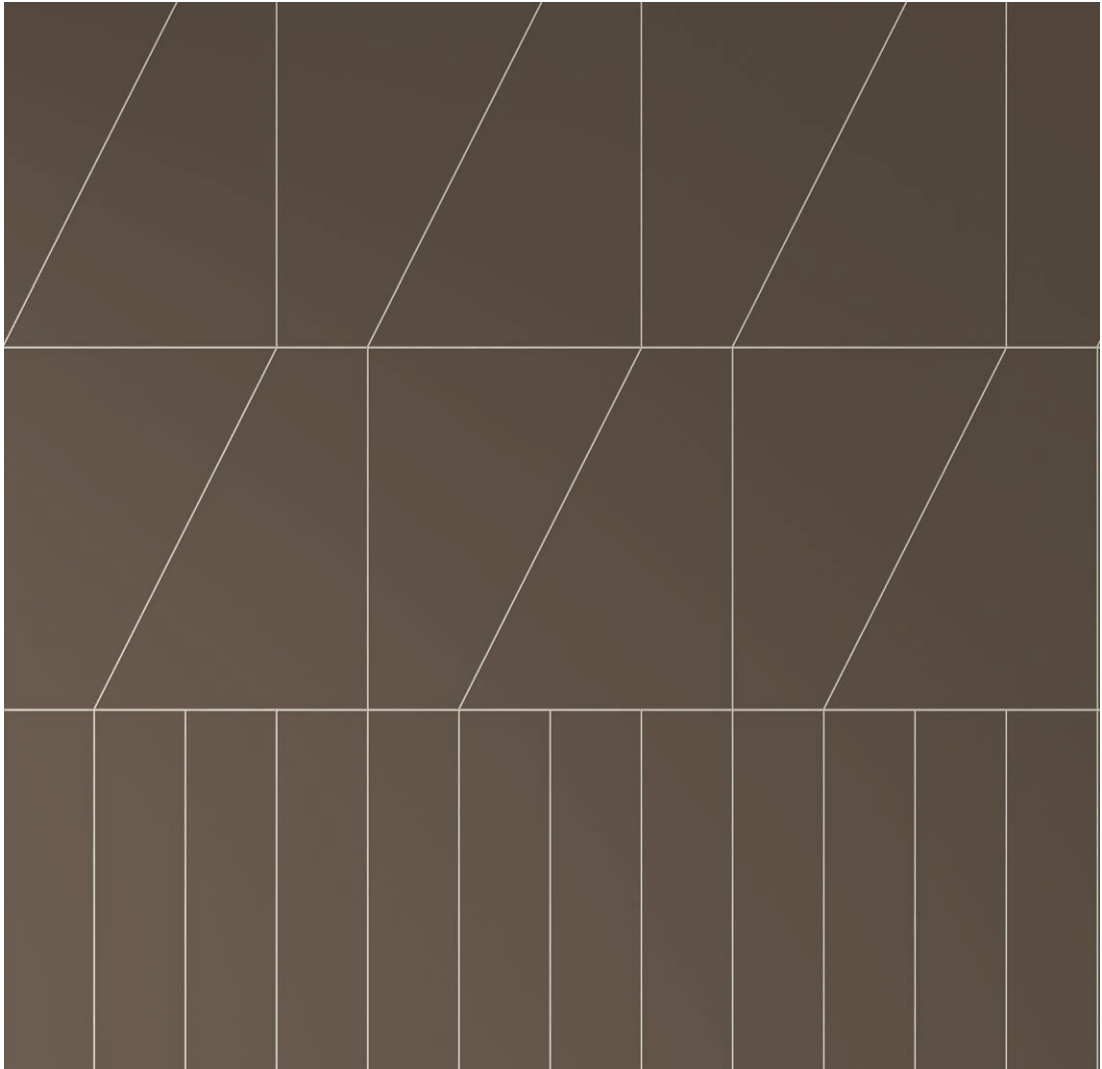

Rivestimento/Wall:  
C2/C6 SH 011 50x50x1 cm

Giunto/Joint:  
Mapei 147 Caribbean









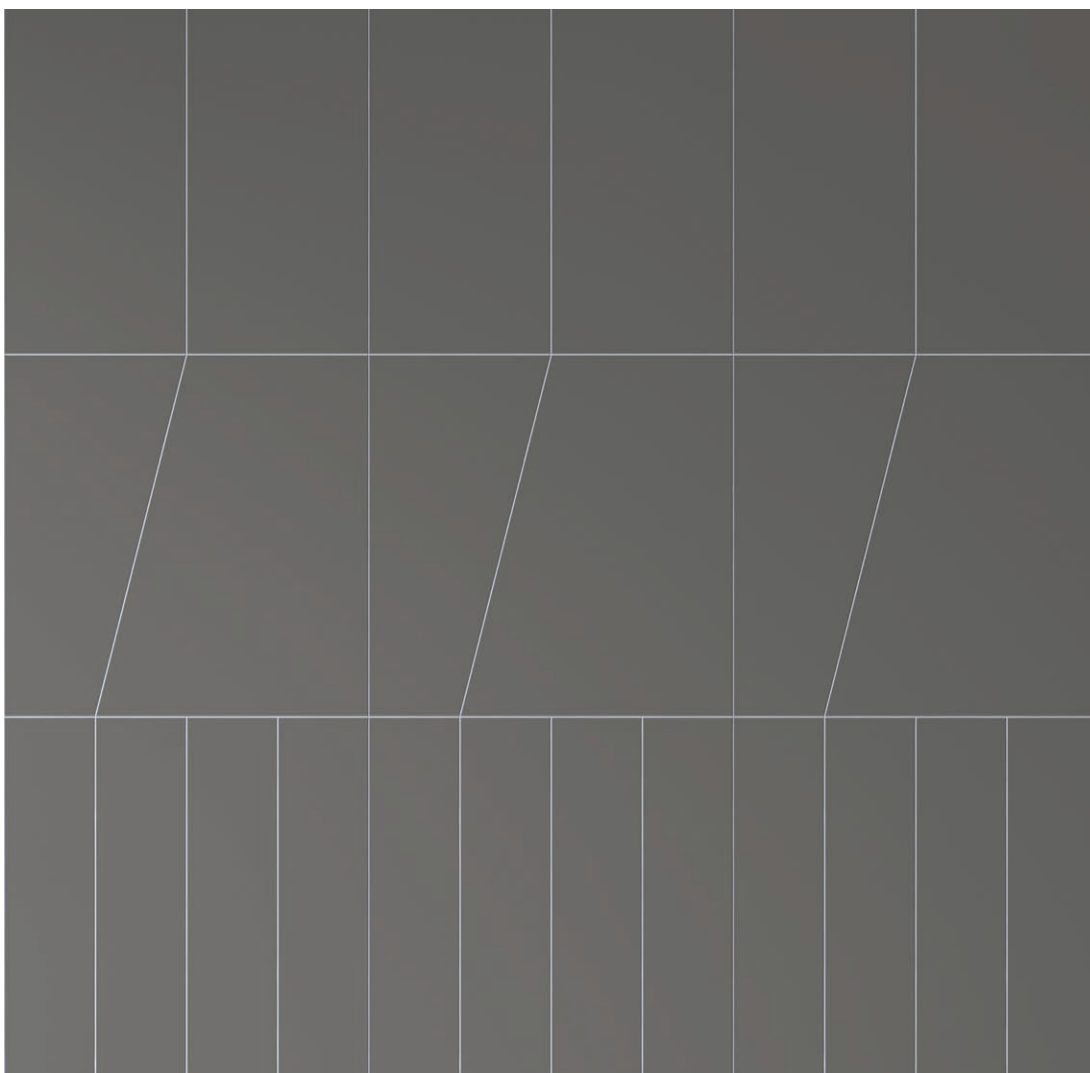

Pagina precedente/Previous page

Pavimento/Floor:  
SH 008 50x50x1 cm

Rivestimento/Wall:  
C1/C4/C7 SH 008 50x50x1 cm  
C7 SH 002 50x50x1 cm

Giunto/Joint:  
Mapei 143 Terracotta

Pavimento/Floor:  
SH 006 50x50x1 cm

Rivestimento/Wall:  
C2/C6 SH 006 50x50x1 cm

Giunto/Joint:  
Mapei 170 Crocus Blue



# CUT 7

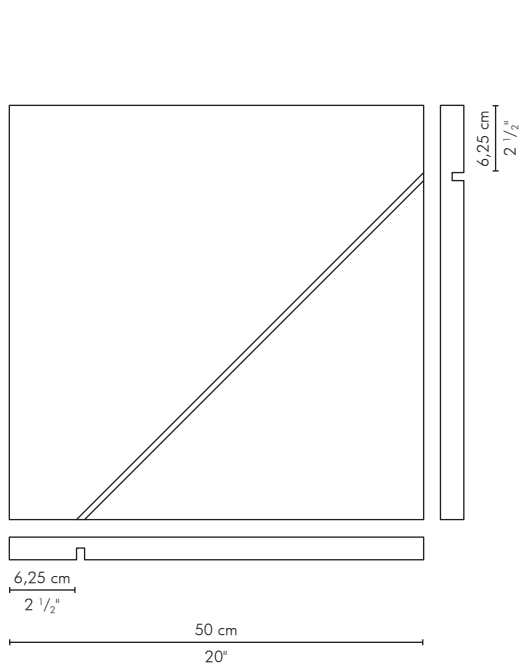

# CUT 6

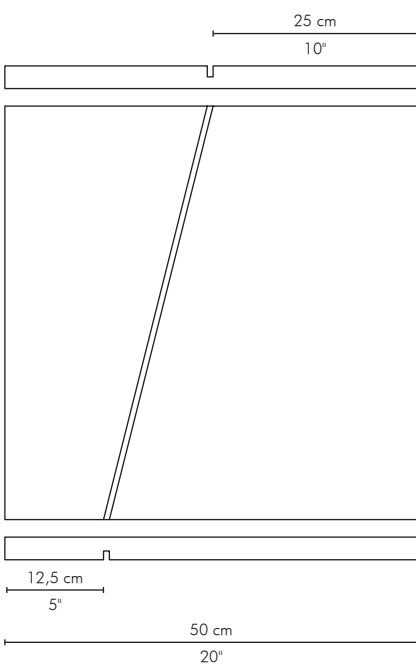

# CUT 5

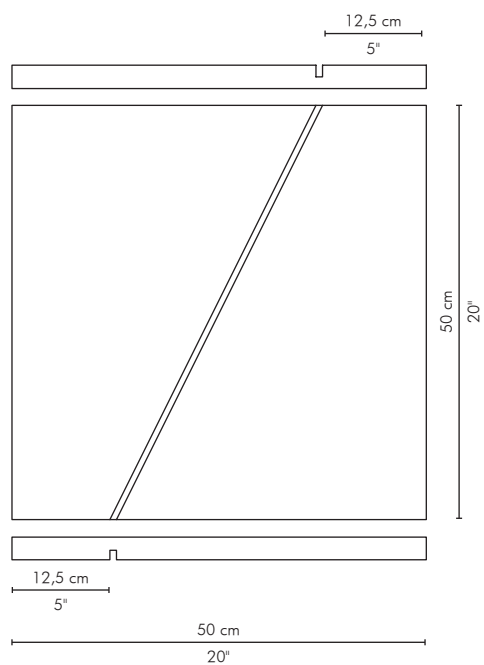

50x50x1 cm - rettificato  
20"x20"x<sup>25</sup>/<sub>64</sub>" - rectified

Decorazione incisa. L'incisione dovrà essere riempita con stucco per piastrelle ceramiche  
Engraved decoration. The engraving should be filled with grouting for ceramic tiles.

# SHADE CUT

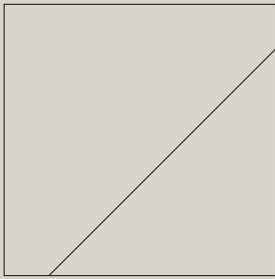

CUT 7

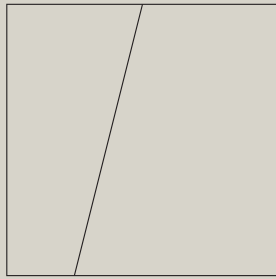

CUT 6

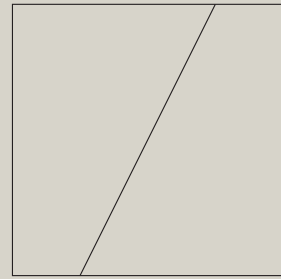

CUT 5

# SHADE

CUT 7 - CUT 6 - CUT 5



C7 SH 001

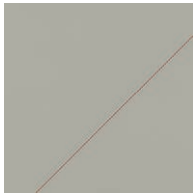

C7 SH 002

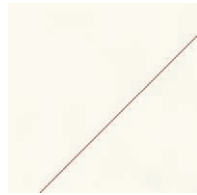

C7 SH 003



C7 SH 004

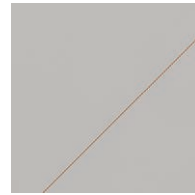

C7 SH 005



C7 SH 006



C7 SH 007

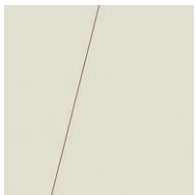

C6 SH 001

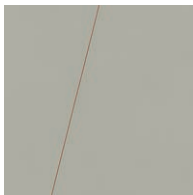

C6 SH 002



C6 SH 003



C6 SH 004

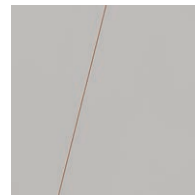

C6 SH 005



C6 SH 006



C6 SH 007

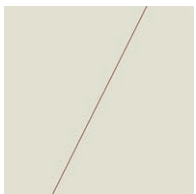

C5 SH 001

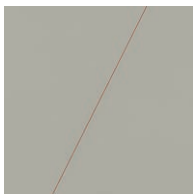

C5 SH 002



C5 SH 003



C5 SH 004



C5 SH 005



C5 SH 006

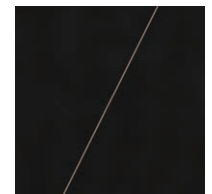

C5 SH 007





C7 SH 008



C7 SH 009

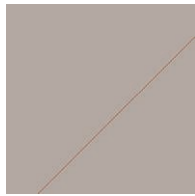

C7 SH 010



C7 SH 011



C7 SH 012



C7 SH 013

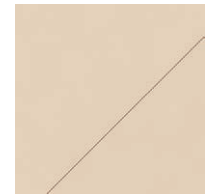

C7 SH 014



C6 SH 008



C6 SH 009

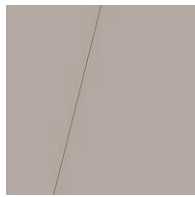

C6 SH 010

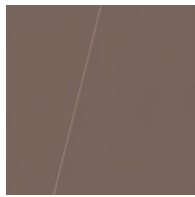

C6 SH 011



C6 SH 012

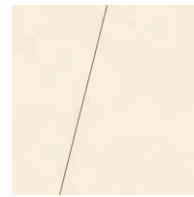

C6 SH 013

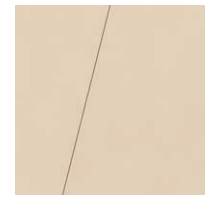

C6 SH 014



C5 SH 008



C5 SH 009

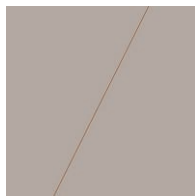

C5 SH 010



C5 SH 011

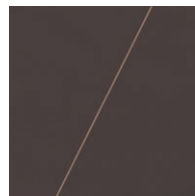

C5 SH 012



C5 SH 013



C5 SH 014

## CUT 4

6,25x50x1 cm  
2 1/2"x20"x25/64"

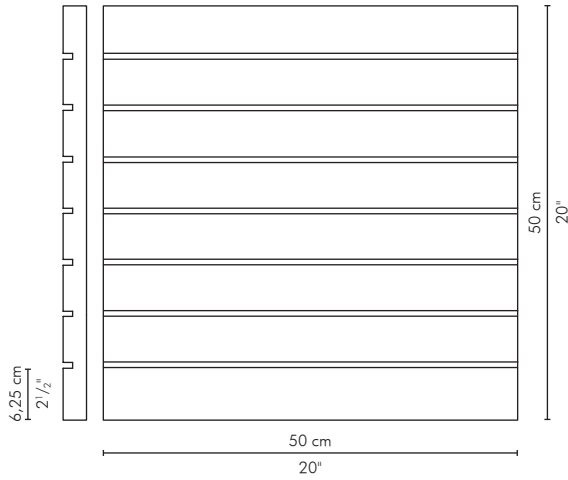

## CUT 3

12,5x50x1 cm - 6,25x50x1 cm  
5"x20"x25/64" - 2 1/2"x20"x25/64"

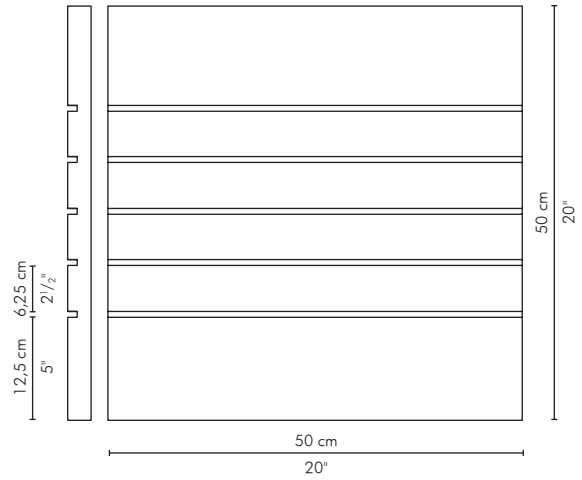

## CUT 2

12,5x50x1 cm  
5"x20"x25/64"

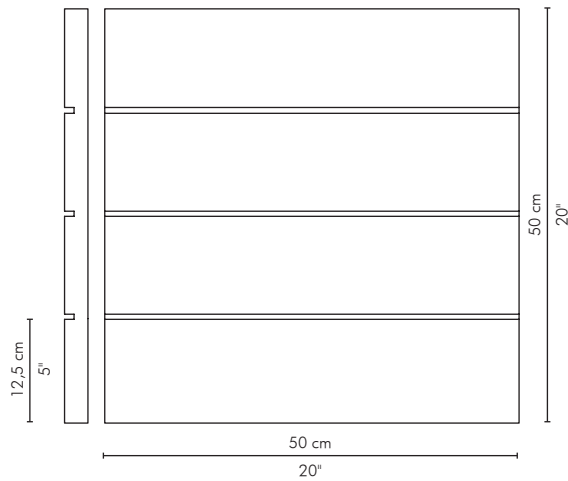

## CUT 1

25x50x1 cm  
10"x20"x25/64"

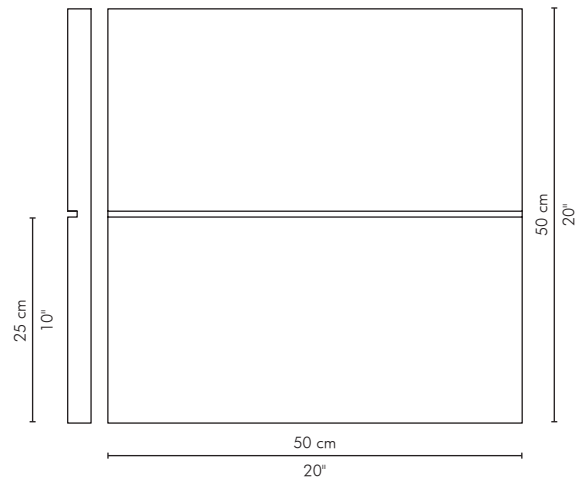

50x50x1 cm - rettificato  
20"x20"x25/64" - rectified

Decorazione incisa. L'incisione dovrà essere riempita con stucco per piastrelle ceramiche  
Engraved decoration. The engraving should be filled with grouting for ceramic tiles.

# SHADE CUT

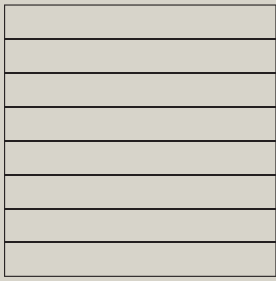

CUT 4

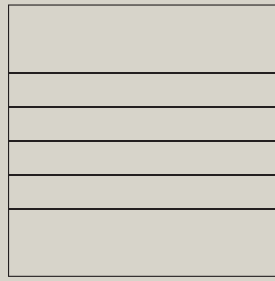

CUT 3

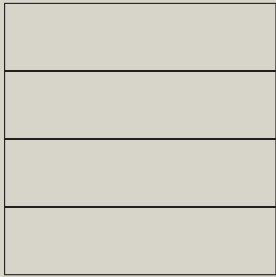

CUT 2



CUT 1

# SHADE

CUT 4 - CUT 3 - CUT 2 - CUT 1

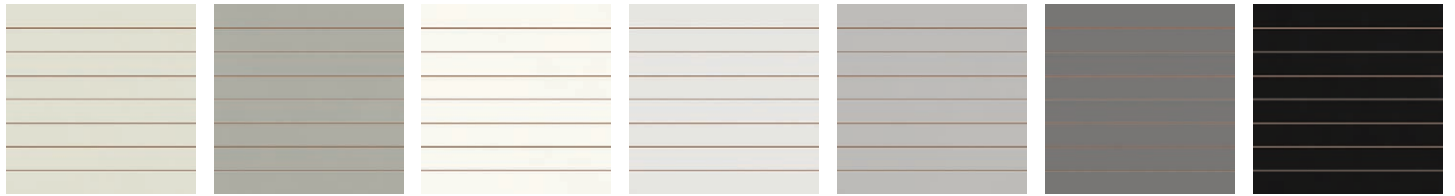

C4 SH 001

C4 SH 002

C4 SH 003

C4 SH 004

C4 SH 005

C4 SH 006

C4 SH 007

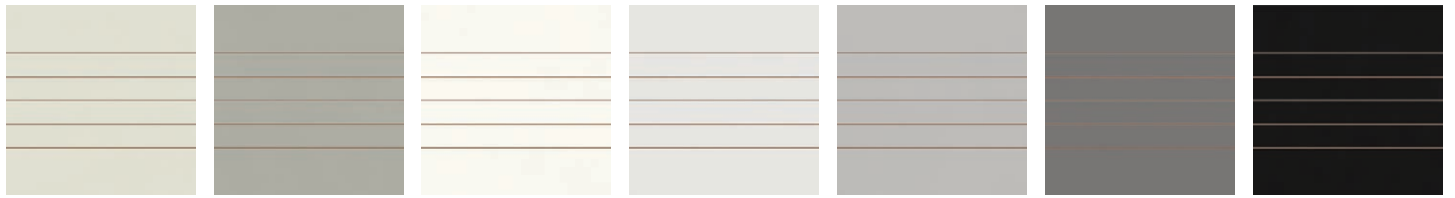

C3 SH 001

C3 SH 002

C3 SH 003

C3 SH 004

C3 SH 005

C3 SH 006

C3 SH 007

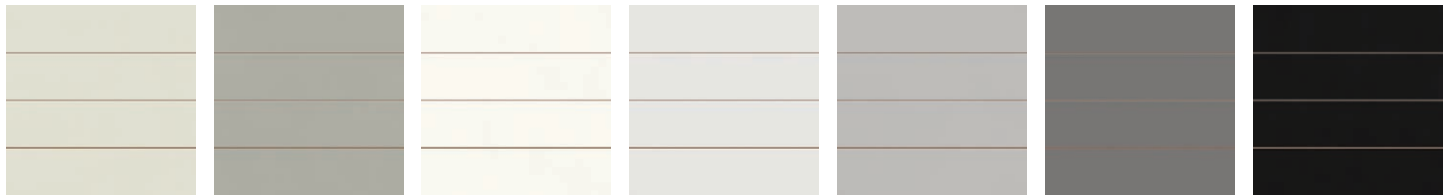

C2 SH 001

C2 SH 002

C2 SH 003

C2 SH 004

C2 SH 005

C2 SH 006

C2 SH 007

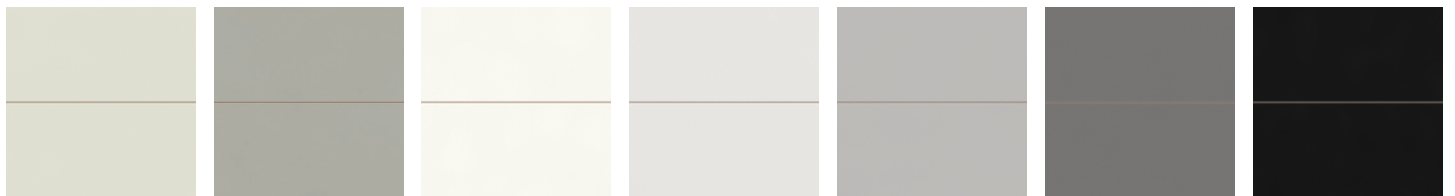

C1 SH 001

C1 SH 002

C1 SH 003

C1 SH 004

C1 SH 005

C1 SH 006

C1 SH 007



C4 SH 008

C4 SH 009

C4 SH 010

C4 SH 011

C4 SH 012

C4 SH 013

C4 SH 014



C3 SH 008

C3 SH 009

C3 SH 010

C3 SH 011

C3 SH 012

C3 SH 013

C3 SH 014



C2 SH 008

C2 SH 009

C2 SH 010

C2 SH 011

C2 SH 012

C2 SH 013

C2 SH 014

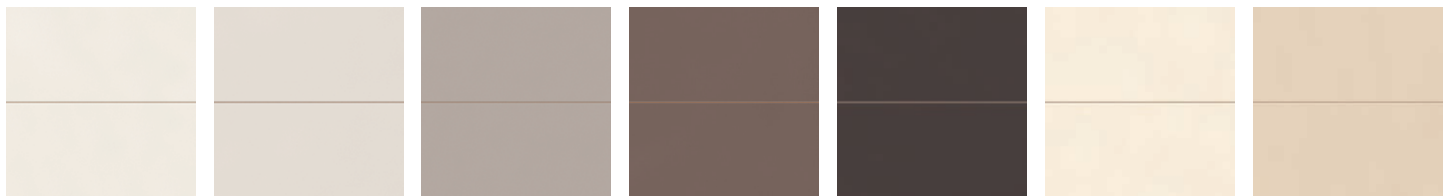

C1 SH 008

C1 SH 009

C1 SH 010

C1 SH 011

C1 SH 012

C1 SH 013

C1 SH 014

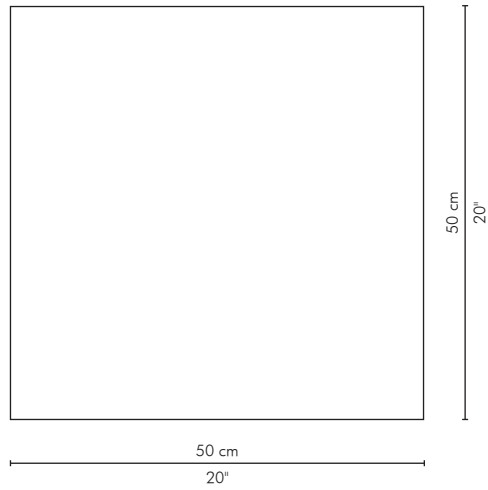

50x50x1 cm - rettificato  
20"x20"x<sup>25</sup>/<sub>64</sub>" - rectified

# SHADE

50

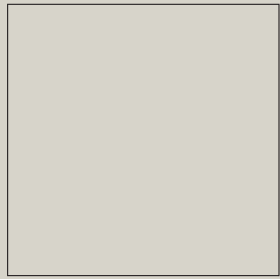

# SHADE

50x50x1 cm - 20"x20"x<sup>25</sup>/<sub>64</sub>"

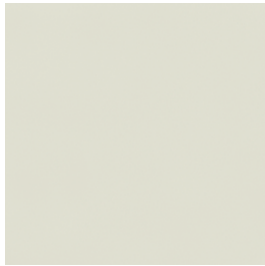

SH 001 PEI IV

RAL 7035



SH 002 PEI IV

RAL 7042

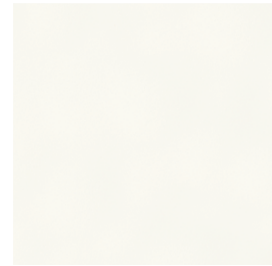

SH 003 PEI IV

RAL 9003



SH 007 PEI II

RAL 9017

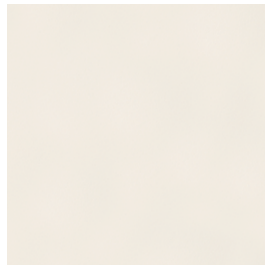

SH 008 PEI IV

RAL 9001

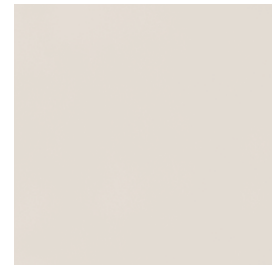

SH 009 PEI IV

RAL 7044



SH 013 PEI IV

RAL 1013



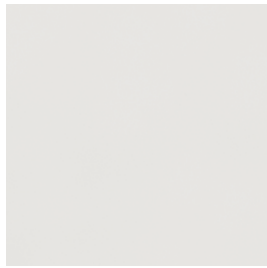

SH 004 PEI IV  
RAL 7047



SH 005 PEI IV  
RAL 7038



SH 006 PEI III  
RAL 7005

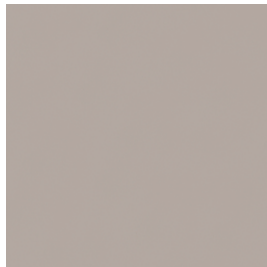

SH 010 PEI IV  
RAL 1019



SH 011 PEI III  
RAL 8025

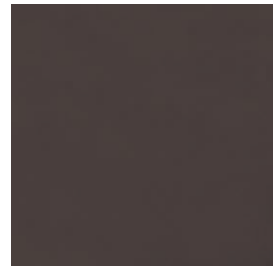

SH 012 PEI III  
RAL 8019



SH 014 PEI IV  
RAL 1015

# SHADE

STICK

10x50x1 cm - 4"x20"x<sup>25</sup>/<sub>64</sub>"



SK 001  
(SH 001 / SH 002 / SH 003)



SK 002  
(SH 003 / SH 004 / SH 005)



SK 003  
(SH 005 / SH 006 / SH 007)



SK 004  
(SH 008 / SH 009 / SH 010)



SK 005  
(SH 010 / SH 011 / SH 012)



SK 006  
(SH 011 / SH 013 / SH 014)

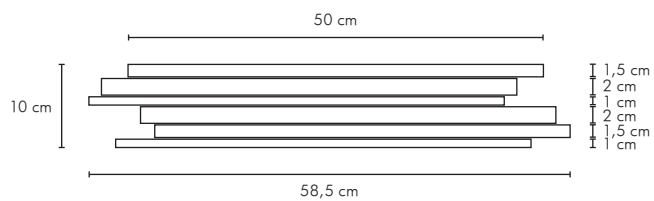

# SHADE

STICK

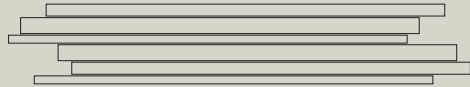

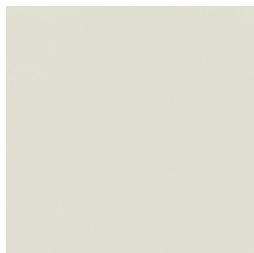

SH 001

LATICRETE 90 Light Pewter

MAPEI 150 Yellow

MAPEI 182 Tormaline



SH 002

MAPEI 112 Medium Grey

MAPEI 150 Yellow

MAPEI 182 Tormaline



SH 003

MAPEI 100 Withe

MAPEI 132 Beige 2000

MAPEI 170 Crocus Blue



SH 007

LATICRETE 22 Midnight Black

MAPEI 141 Caramel

MAPEI 145 Terra di Siena



SH 008

LATICRETE 16 Siltstone

MAPEI 141 Caramel

MAPEI 145 Terra di Siena

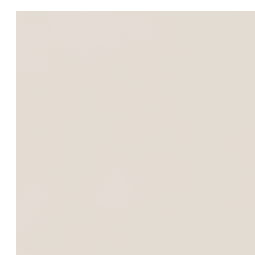

SH 009

MAPEI 133 Sand

MAPEI 141 Caramel

MAPEI 145 Terra di Siena



SH 013

MAPEI 130 Jasmine

MAPEI 132 Beige 2000

MAPEI 170 Crocus Blue

# GIUNTI

## JOINTS SUGGESTION

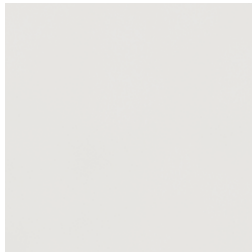

SH 004

MAPEI 111 Silver Grey

MAPEI 150 Yellow

MAPEI 182 Tormaline



SH 005

MAPEI 110 Manhattan 2000

MAPEI 150 Yellow

MAPEI 182 Tormaline



SH 006

MAPEI 114 Antracite

MAPEI 150 Yellow

MAPEI 182 Tormaline

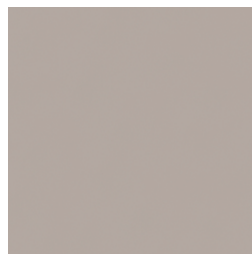

SH 010

MAPEI 134 Silk

MAPEI 141 Caramel

MAPEI 145 Terra di Siena

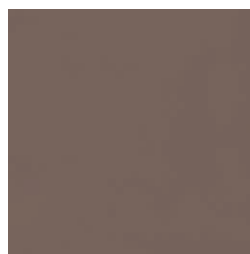

SH 011

MAPEI 144 Chocolate

MAPEI 132 Beige 2000

MAPEI 170 Crocus Blue

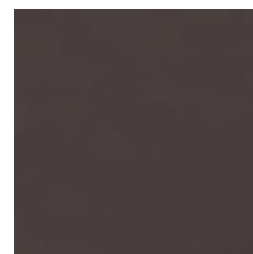

SH 012

MAPEI 149 Volcano Sand

MAPEI 132 Beige 2000

MAPEI 170 Crocus Blue



SH 014

MAPEI 132 Beige 2000

MAPEI 141 Caramel

MAPEI 145 Terra di Siena

Colori / Colours

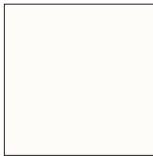

006  
verniciato bianco  
satinato  
white painted satin



007  
verniciato nero  
satinato  
black painted satin

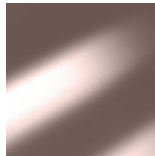

004  
brillantato rame  
polished copper



008  
brillantato oro  
polished gold

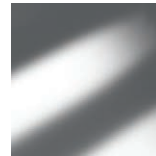

009  
brillantato cromo  
polished titanium

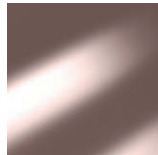

004  
brillantato rame  
polished copper

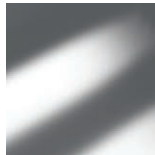

009  
brillantato cromo  
polished titanium

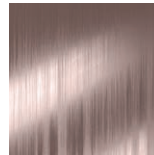

003  
satinato rame  
brushed copper

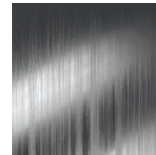

010  
satinato argento  
silver satin

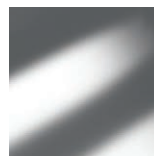

009  
brillantato cromo  
polished titanium

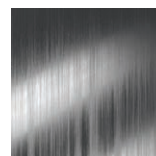

010  
satinato argento  
silver satin

# PROFILI PROFILES

Profili in alluminio brillantato / Profiles in glossy aluminium

Formati / Sizes

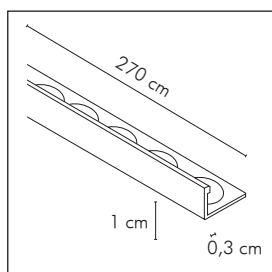

PR  
(1x270x0,3 cm /  
 $25/64'' \times 106 \frac{5}{16}'' \times 1/8''$ )  
profilo/profile

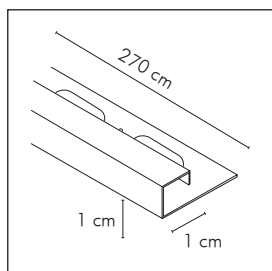

SP  
(1x270x1 cm /  
 $25/64'' \times 106 \frac{5}{16}'' \times 25/64''$ )  
profilo/profile

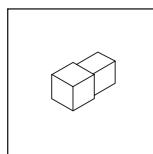

SP/A  
(1x1 cm /  $25/64'' \times 25/64''$ )  
terminale/end

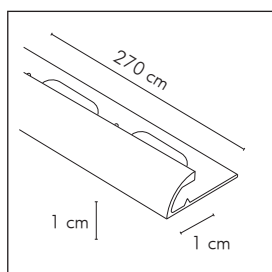

SP C  
(1x270x1 cm /  
 $25/64'' \times 106 \frac{5}{16}'' \times 25/64''$ )  
profilo/profile

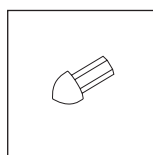

SP C/A  
(1x1 cm /  $25/64'' \times 25/64''$ )  
terminale/end











## Voci di capitolato / Tender specifications

Piastrelle di ceramica pressate a secco con basso assorbimento di acqua ( $0,5\% < E_b \leq 3\%$ ) Gruppo B1b - M - GL EN 14411:2012 appendice H.  
 Glazed ceramic tiles, dry pressed with low water absorption ( $0,5\% < E_b \leq 3\%$ ) Group B1b - M - GL EN 14411:2012 H appendix.

## Dimensioni e qualità della superficie / Dimensions and surface quality

formato nominale nominal shape	dimensione di fabbricazione actual size		metodo di prova test methods	requisiti requirements		risultati Vogue Vogue results	
50x50 cm (20"x20")	lati sides	500x500 mm	EN ISO 10545-2	lati sides	$\pm 0,6\%$	lati sides	$\pm 0,3\%$
	spessore thickness	10 mm		spessore thickness	$\pm 5\%$	spessore thickness	$\pm 4\%$
Rettilineità dei lati (superficie di esercizio) Straightness of sides (working surface)			EN ISO 10545-2	$\pm 0,5\%$	$\pm 0,4\%$		
Ortogonalità Squareness			EN ISO 10545-2	$\pm 0,5\%$	$\pm 0,4\%$		
Planarità della superficie Flatness			EN ISO 10545-2	$\pm 0,5\%$	$\pm 0,4\%$		
Qualità della superficie Surface quality			EN ISO 10545-2	min. 95%	min. 95%		

## Proprietà fisiche / Physical properties





prova test			metodo di prova test methods	requisiti requirements	risultati Vogue Vogue results
 Massa d'acqua assorbita (%) Water absorption (%)			EN ISO 10545-3	$0,5\% < E_b \leq 3,0\%$	1,5 %
 Resistenza di rottura Tensile strength	spessore thickness $\geq 7,5$ mm		EN ISO 10545-4	1.100 N min.	> 1.700 N
 Modulo di rottura Modulus of rupture			EN ISO 10545-4	30 N/mm <sup>2</sup> min.	> 40 N/mm <sup>2</sup>
 P.E.I. Resistenza all'abrasione (P.E.I.) Abrasion resistance (P.E.I.)			EN ISO 10545-7	riportare la classe di abrasione quote the abrasion class	vedi pagina prodotto refer to product page
 Coefficiente di dilatazione termica lineare Coefficient of linear thermal expansion			EN ISO 10545-8	metodo di prova disponibile test method available	< $6,9 \times 10^{-6} / ^\circ\text{C}$
 Resistenza agli sbalzi termici Thermal shock resistance			EN ISO 10545-9	metodo di prova disponibile test method available	garantita guaranteed
 Resistenza al cavillo Crazing resistance			EN ISO 10545-11	richiesta required	garantita guaranteed
 Resistenza al gelo Frost resistance			EN ISO 10545-12	metodo di prova disponibile test method available	garantita guaranteed
 Dilatazione dovuta all'umidità Expansion to humidity			EN ISO 10545-10	metodo di prova disponibile test method available	< 0,04%
 Resistenza all'urto Impact resistance			EN ISO 10545-5	metodo di prova disponibile test method available	> 0,6 (vedi appendice P catalogo generale) (see P appendix general catalogue)





# SCHEDE TECNICHE

## TECHNICAL CHARTS

### Proprietà chimiche / *Chemical properties*

prova test	metodo di prova test methods	requisiti requirements	risultati Vogue Vogue results
 Resistenza alle macchie Stain resistance	EN ISO 10545-14	classe 3 min.	3 min. (vedi appendice P catalogo generale) (see P appendix general catalogue)
 Resistenza ai prodotti chimici d'uso domestico ed agli additivi per piscina Resistance to chemical products for housekeeping and to the additives used in swimming-pools	EN ISO 10545-13	GB min.	GB min.
 Resistenza ad acidi e basi a bassa concentrazione Resistance to acids and bases at low concentrations	EN ISO 10545-13	indicata dal produttore indicated by the producer	GLB min.
 Resistenza ad acidi e basi ad alta concentrazione Resistance to acids and bases at high concentrations	EN ISO 10545-13	metodo di prova disponibile test method available	GHB min.
 Pb Cd Cessione di piombo e cadmio Lead and cadmium losses	EN ISO 10545-15	metodo di prova disponibile test method available	disponibile a richiesta available if required

### Altre prove / *Other tests*

prova test	metodo di prova test methods	requisiti requirements	risultati Vogue Vogue results
 Resistenza dei colori alla luce Colour resistance to light	DIN 51094	non previsto not foreseen	garantita guaranteed
 Reazione al fuoco Reaction to the fire	senza prova without test	decisione 96/603/CE decision 96/603/CE	classe A1

### Giunto e componibilità dei formati / *Modularity and laying*

Per ottenere un corretto risultato di posa il materiale deve essere posato con un giunto non inferiore a 2 mm (UNI 11493:2013).

Per rispettare la componibilità dei prodotti della collezione Shade Cut il giunto dovrà essere di 2 mm.

*To obtain a correct laying result the material should be laid with joints of no less than 2 mm (UNI 11493:2013). To observe the modularity of the products of the Shade Cut collection, the joint must be 2 mm wide.*



[www.ceramicavogue.it](http://www.ceramicavogue.it)

made in italy

ART DIRECTION: MARCANTE - TESTA

Immagini : Terzo Piano

Styling : Elisabetta Bongiorno

Ufficio stampa: [info@sabrinagiacchetti.it](mailto:info@sabrinagiacchetti.it)

Stampa: Arti Grafiche Biellesi (BI)

Stampato in Italia Giugno 2018

Ceramica VOGUE  
è un marchio di

altaeco

GRUPPO INDUSTRIALE



Socio Ordinario  
del GBC Italia



Ceramica VOGUE  
SS 143 Loc. Vergnasco  
13882 Cerrione (BI) ITALIA  
T. +39.015.672.1  
Fax +39.015.671.626 (Italia)  
Fax +39.015.671.352 (Export)  
[info@cervogue.com](mailto:info@cervogue.com)

Altaeco USA  
7121 Austin Ave. Niles, Illinois 60714  
[info.usa@altaeco.com](mailto:info.usa@altaeco.com)

Ceramica  
VOGUE

TILES FOR ARCHITECTURE

