

APOLLO

2021

design_Brian Sironi

Luce e Acqua: Apollo è una collezione di soffioni che mette insieme questi due elementi, connettendoli in un'unica composizione di forme pure.

È un oggetto ibrido in cui nessuna delle due funzioni prevale percettivamente: è una lampada, ma allo stesso tempo un soffione per doccia.

Apollo introduce una nuova tipologia di soffioni che a prima vista può lasciare spiazzati, perché non è facile comprendere la sua doppia natura capace di emanare luce e acqua, ma l'ambiguità tipologica è parte del suo fascino.

I soffioni sono una composizione di linee tubolari che sovverte il paradigma dei soffioni esistenti, mentre la lampada, che può assumere varie forme, è riassunta in Apollo in una sfera circolare.

Apollo è dunque una fonte di luce e una sorgente d'acqua che rende l'esperienza della doccia particolarmente piacevole: ci si lascia inondare da una pioggia luminosa primordiale, che crea un'atmosfera di rilassamento anche grazie al comfort visivo che viene generato, creando un'esperienza olistica che appaga più sensi.

Apollo è considerato nella mitologia classica il dio del sole e quindi della luce e del calore, ma la sua nascita è avvenuta in acqua e i due elementi si integrano perfettamente nella simbologia di cui la collezione si fa portatrice.

La collezione è composta da un elemento a parete e due a soffitto.

Il pezzo maggiormente iconico, l'elemento a parete, è realizzato in fusione d'ottone a forma di Y ed è il risultato di un'attenta riflessione sull'architettura di prodotto del sistema soffione, nel quale i tre rami acqua-luce-fissaggio sono concepiti in modo paritario.

L'aspetto tecnologico riveste un ruolo fondamentale nell'intero progetto, perché ha permesso la piena attuazione dell'idea originaria, soprattutto dal punto di vista della miniaturizzazione dei componenti.

I soffioni sono dotati di getti a pioggia o chiodo di ultima generazione.

L'illuminazione a Led IP67 si accende simultaneamente all'erogazione dell'acqua.

Light and Water: Apollo is a collection of shower heads that brings these two elements together, connecting them in a single composition of pure forms.

It is a hybrid object in which neither function prevails perceptively: it is a lamp, but at the same time a shower head.

Apollo introduces a new type of showerhead that at first glance can leave you a little perplexed, because it is not easy to understand its dual nature capable of emanating light and water, but the typological ambiguity is part of its charm. The showerheads are a composition of tubular lines that subvert the paradigm of existing showerheads, while the lamp, which can take various forms, is summarized in Apollo in a circular sphere.

Apollo is therefore a source of light and a source of water that makes the shower experience particularly pleasant: allowing yourself to be flooded by a primordial luminous rain, which creates a relaxing atmosphere also thanks to the visual comfort that is generated, creating a holistic experience that satisfies multiple senses.

Apollo is the god of the sun in classical mythology and therefore of light and heat, but his birth took place in water and the two elements are perfectly integrated into the symbolism of which the collection is the bearer.

The collection consists of a wall element and two ceiling elements.

The most iconic piece, the wall element, is made of cast brass in a Y shape and is the result of careful reflection on the architectural aspect of the showerhead product system, in which the three water-light-fixing branches are conceived equally.

The technological aspect plays a fundamental role in the entire project, because it allowed the full implementation of the original idea, especially from the point of view of the miniaturization of the components.

The shower heads are equipped with the latest generation rain or nail jets.

The IP67 LED lighting turns on simultaneously with the water supply.



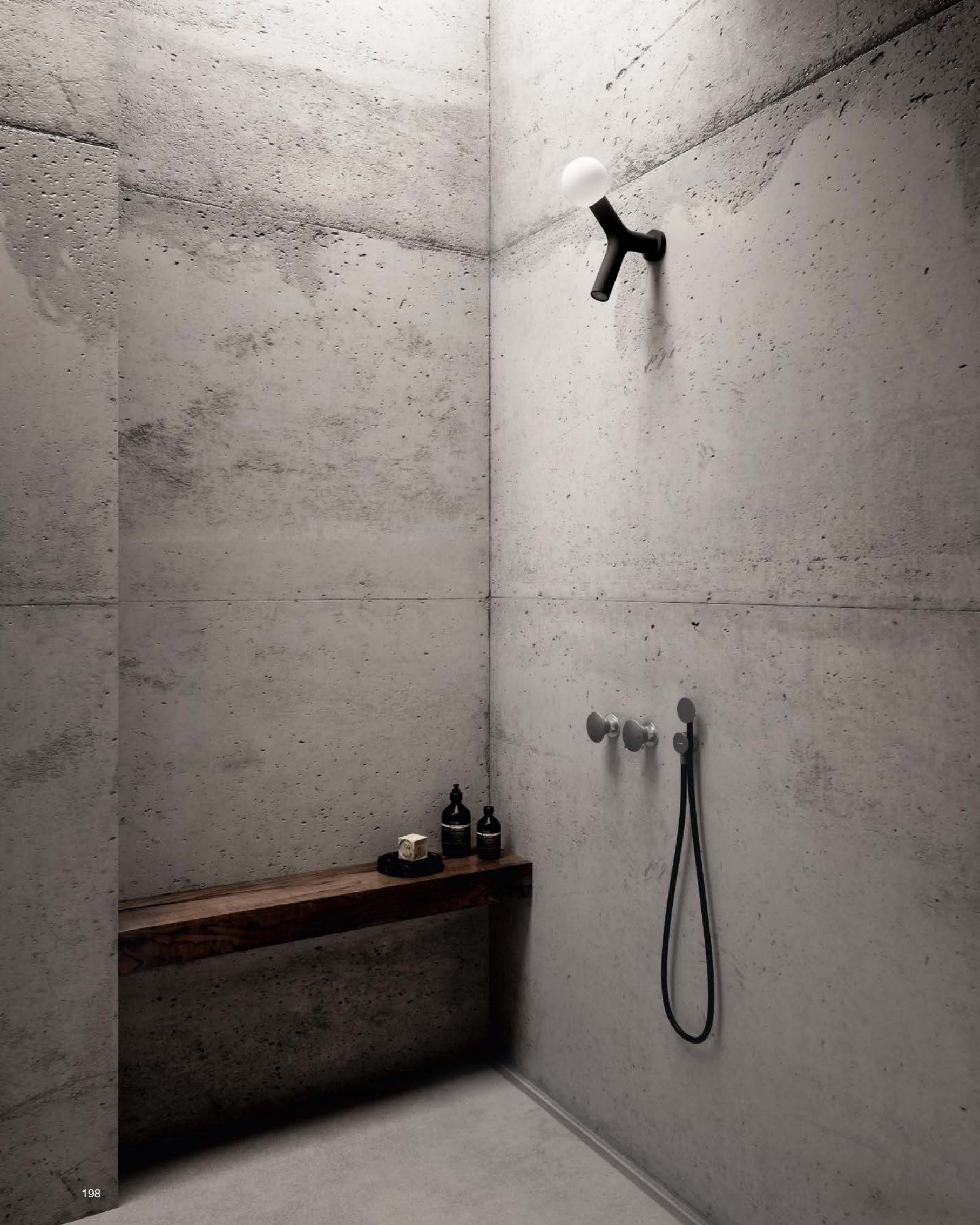







<i>h</i>	<i>p</i>	<i>l</i>	<i>art.</i>
32,5	27	11	APOLLO2

Soffione a parete in ottone, completo di illuminazione a LED con accensione automatica simultanea all'erogazione dell'acqua e spegnimento posticipato di 120 sec. Struttura nelle finiture disponibili.

Wall-mounted brass showerhead complete with LED lighting that automatically turns on simultaneously with the water supply and delayed switching off of 120 sec. Structure in the available finishes.

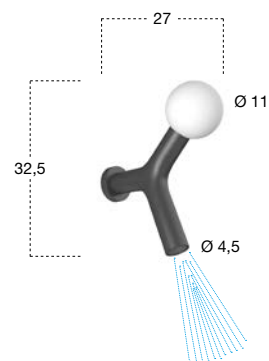

















<i>h</i>	<i>p</i>	<i>l</i>	<i>art.</i>
25	20	7,5	APOLLO1

Soffione a parete in ottone, senza illuminazione. Struttura nelle finiture disponibili.

Wall-mounted brass showerhead without lighting. Structure in the available finishes.

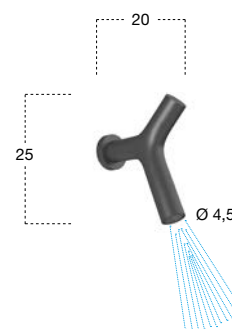













<i>h</i>	<i>p</i>	<i>l</i>	<i>art.</i>
40,5	11	25,5	APOLLO3

Soffione a soffitto in ottone, completo di illuminazione a LED con accensione automatica simultanea all'erogazione dell'acqua e spegnimento posticipato di 120 sec. Struttura nelle finiture disponibili.

Brass ceiling showerhead complete with LED lighting that automatically turns on simultaneously with the water supply and delayed switching off of 120 sec. Structure in the available finishes.

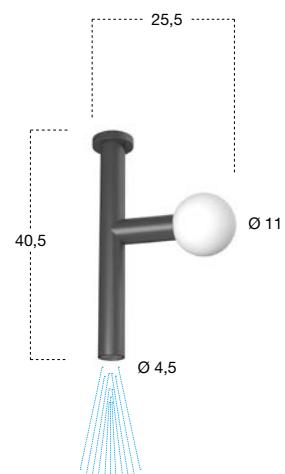

Doccia
Shower



Chiodo
Nail



Doccia
Shower

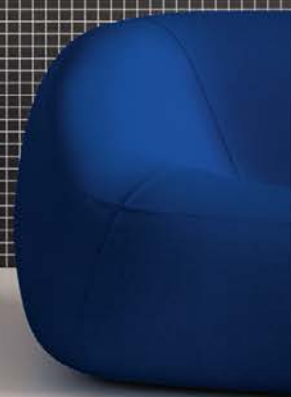



<i>h</i>	<i>p</i>	<i>l</i>	<i>art.</i>
32,5	14	62	APOLLO4

Soffione a soffitto in ottone, completo di illuminazione a LED a 2 getti, chiodo centrale e doccia laterale con inclinazione regolabile. Accensione automatica simultanea all'erogazione dell'acqua e spegnimento posticipato di 120 sec. Completo di piastra per fissaggio a cartongesso. Struttura nelle finiture disponibili.

Brass ceiling showerhead complete with LED lighting and 2 jets of water, central nail jet and side shower with adjustable inclination. The lighting automatically turns on simultaneously with the water supply and has a delayed switching off of 120 sec. Complete with a fixing plate for plasterboard. Structure in the available finishes.

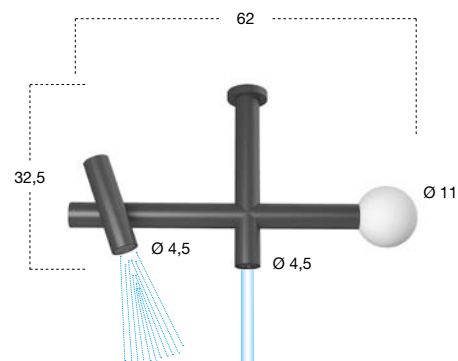

GHOST

2019

design_AL Studio

Scompare totalmente alla vista, lasciando all'acqua e al suo effetto rigenerante il ruolo di unica protagonista.

Perfettamente integrato nel soffitto, il soffione a scomparsa totale Ghost si rivela solo quando entra in funzione.

Una volta spento, solo i fori nei quali risiedono i piccoli ma performanti ugelli rivelano la sua presenza, delimitando una griglia puntiforme regolare pronta a trasformarsi in un'area di relax e benessere assoluto grazie alla perfetta miscelazione di aria e acqua.

Costituito da una piastra quadrata o rettangolare continua in Flumood, nella quale sono stati "annegati" gli ugelli, il soffione si inserisce senza soluzione di continuità con il soffitto e dopo una perfetta rasatura può essere verniciato dello stesso colore della superficie che lo ospita.

Un'evoluzione a soffitto del percorso intrapreso da antoniolupi con i camini a parete, proseguito con i lavabi integrati e già declinato nei soffioni con Meteo Out e Meteo In.

Oggetti eleganti che giocano sui concetti di presenza/assenza, che esprimono la propria forma come risultante di un gesto, spesso dirompente, a volte leggero e delicato.

Come nel lavabo Strappo, che esce con vigore dalla parete, in Ghost sembra essere la forza dell'acqua che "buca" la superficie continua del soffitto per generare una pioggia rivitalizzante, chiaro riferimento all'esperienza generata dal fenomeno naturale.

Una soluzione elegante, minimale e perfettamente integrata, nella quale ogni dettaglio è stato studiato sia sotto l'aspetto estetico, sia dal punto di vista funzionale.

Un'apposita Tool permette infatti una volta installato il soffione di rimuovere singolarmente gli ugelli e ispezionarli per poi ricollocarli nel loro alloggiamento.

Un accorgimento che consente di effettuare una perfetta manutenzione senza dover ricorrere a nessun compromesso con la perfetta continuità della superficie.

It totally disappears, leaving the role of protagonist to water and its regenerating effect.

Perfectly integrated into the ceiling, the Ghost retractable shower head is revealed only when it comes into operation.

Once turned off, only the holes, in which the small but performing nozzles reside, reveal its presence defining a regular grid ready to transform into an area of relaxation and absolute well-being thanks to the perfect mixing of air and water.

Consisting of a square or rectangular Flumood plate in which the nozzles have been "drowned", the shower head fits seamlessly with the ceiling and after a perfect shaving can be painted the same color as the surface that houses it.

An evolution on the ceiling of the path taken by antoniolupi with wall-integrated fireplaces, continued with integrated sinks and already declined in the shower heads with Meteo Out and Meteo In.

Elegant objects that play on the concepts of presence / absence, which express their form as a result of a gesture, often disruptive, sometimes light and delicate.

As in the Strappo washbasin, which comes out vigorously from the wall, in Ghost it seems to be the force of the water that "punctures" the continuous surface of the ceiling to generate a revitalizing rain, clear reference to the experience generated by the natural phenomenon.

An elegant, minimal and perfectly integrated solution, in which every detail has been studied both from an aesthetic and a functional point of view. In fact, once the showerhead is installed, a special tool allows you to remove the nozzles individually for inspection and then replace them in their spot.

A measure that allows perfect maintenance without having to resort to any compromise with the perfect continuity of the surface.



ART. GHOST

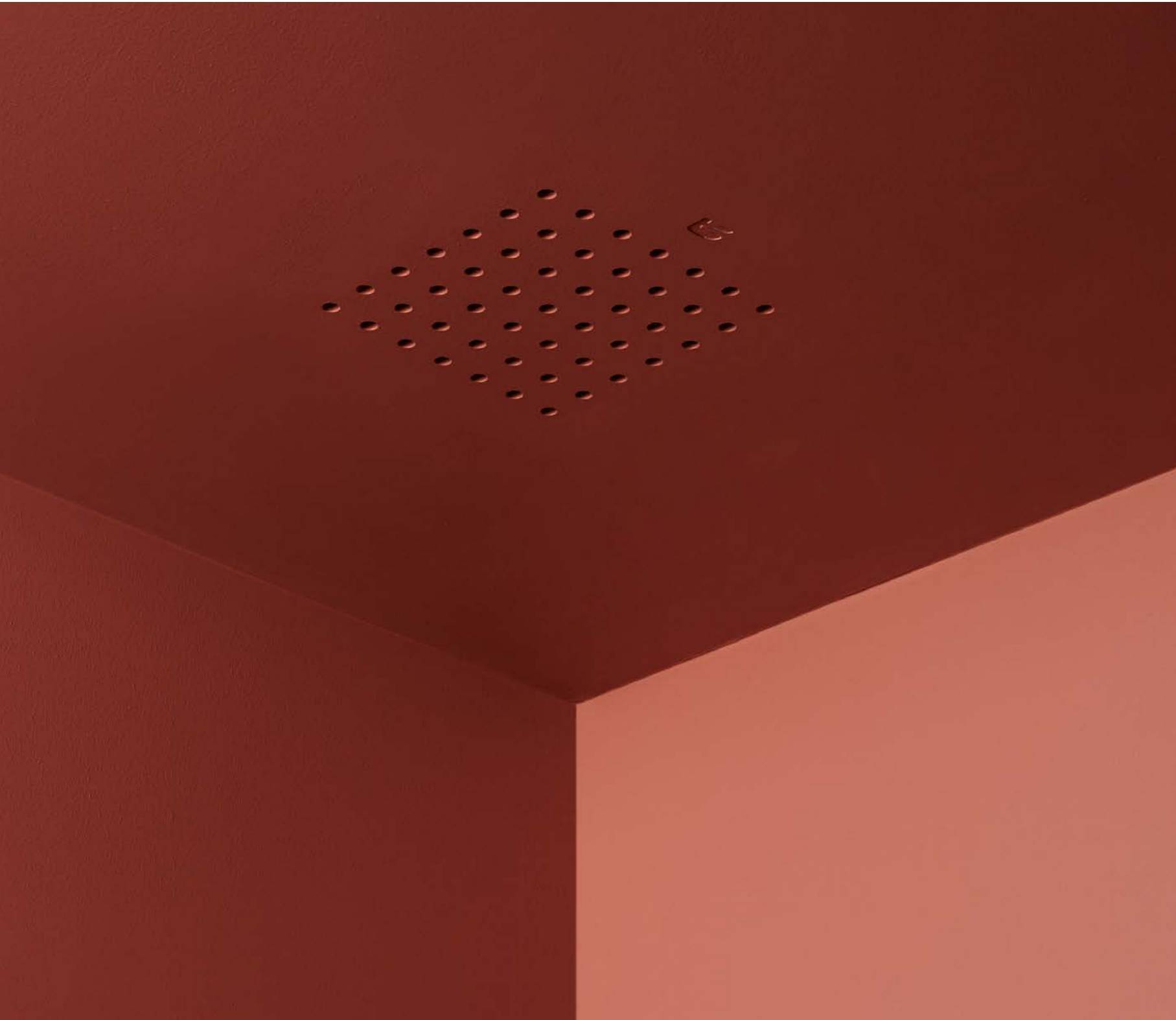

ART. GHOST_BIG

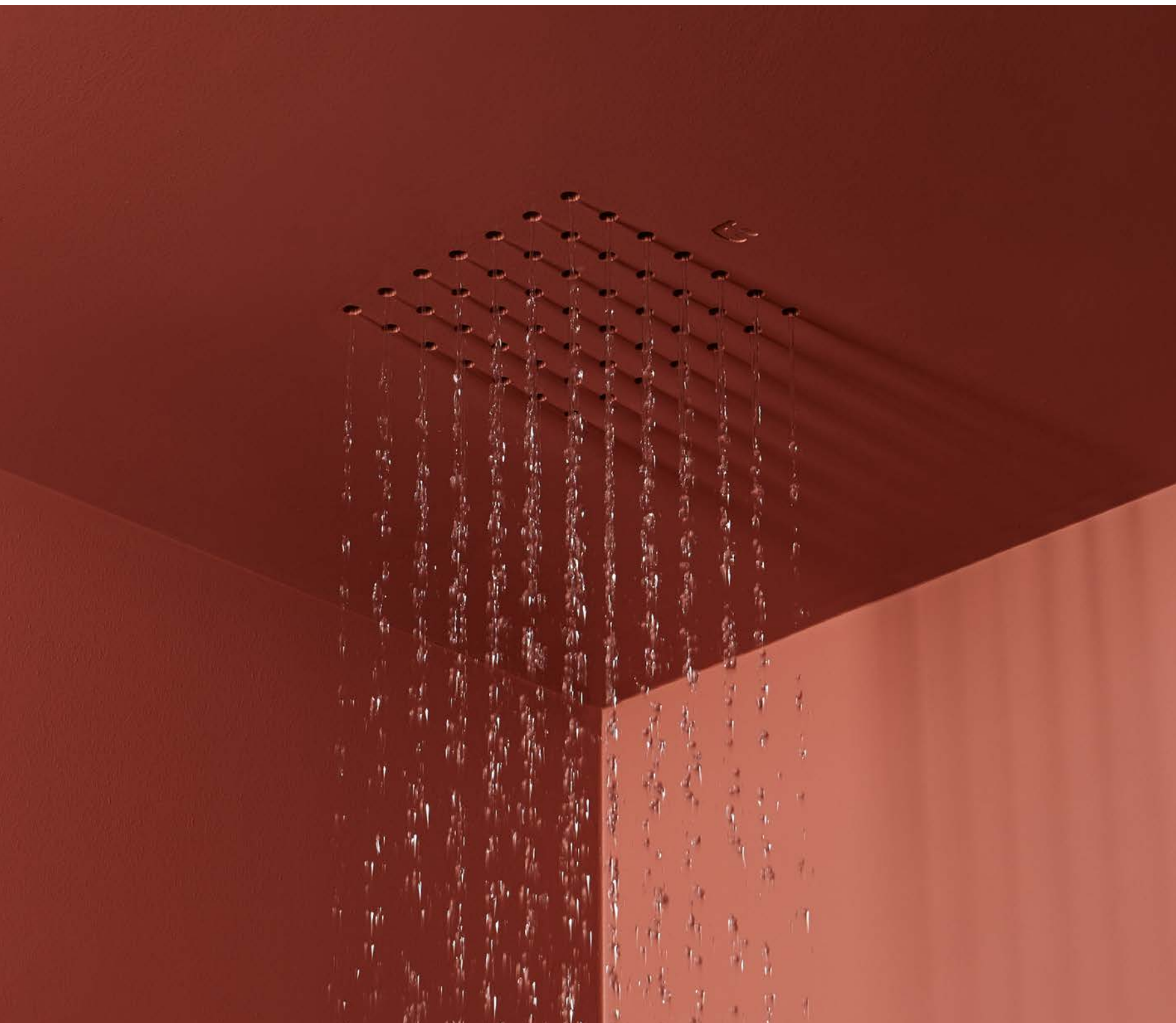

ART. GHOST_BIG





ART. GHOST_BIG

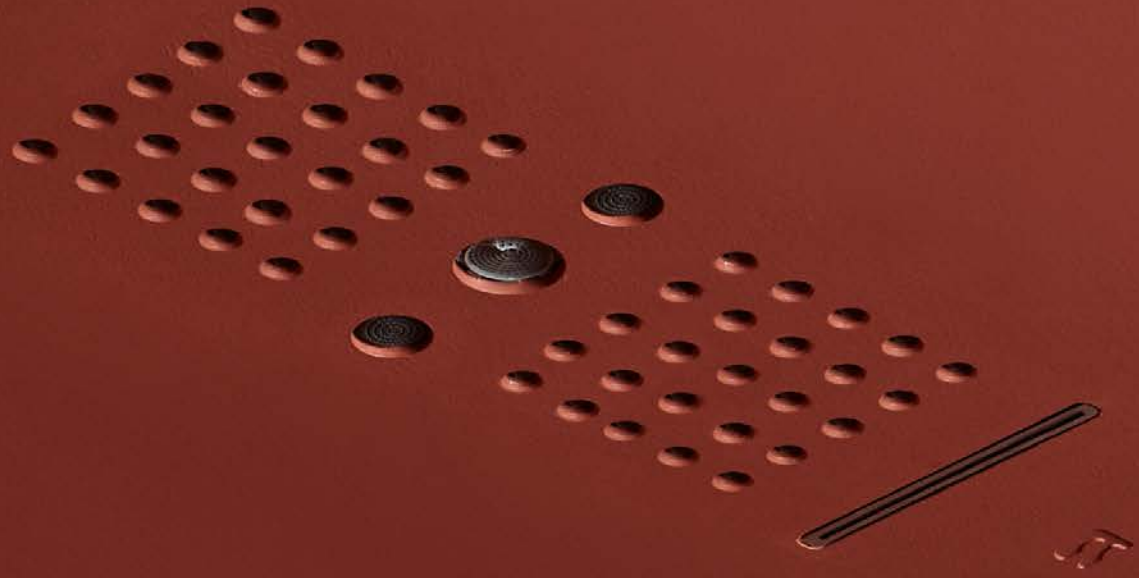

Cascata
Waterfall



Doccia
Shower



Chiodo
Nail



Spray
Spray







ART. GHOST_COMBI

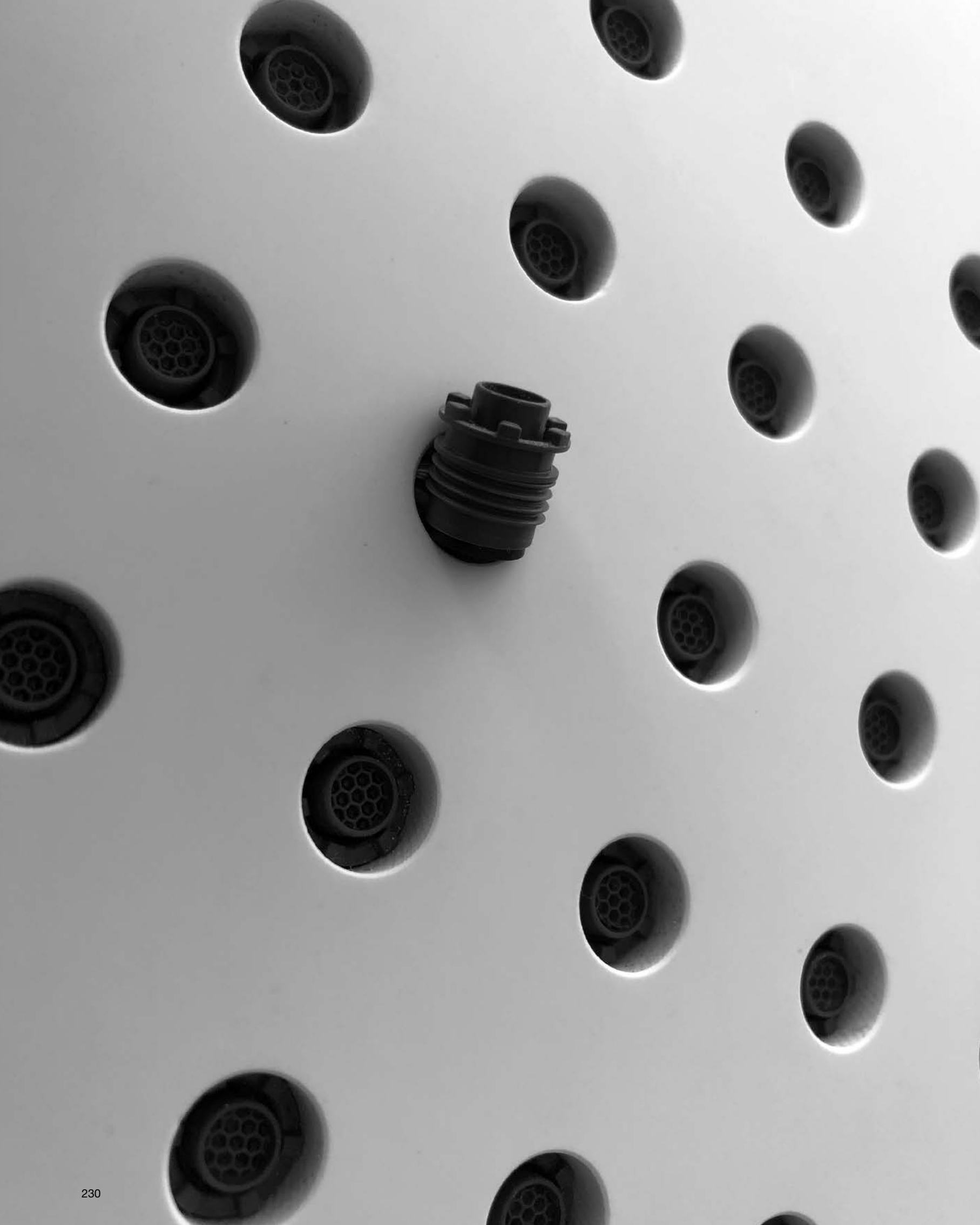

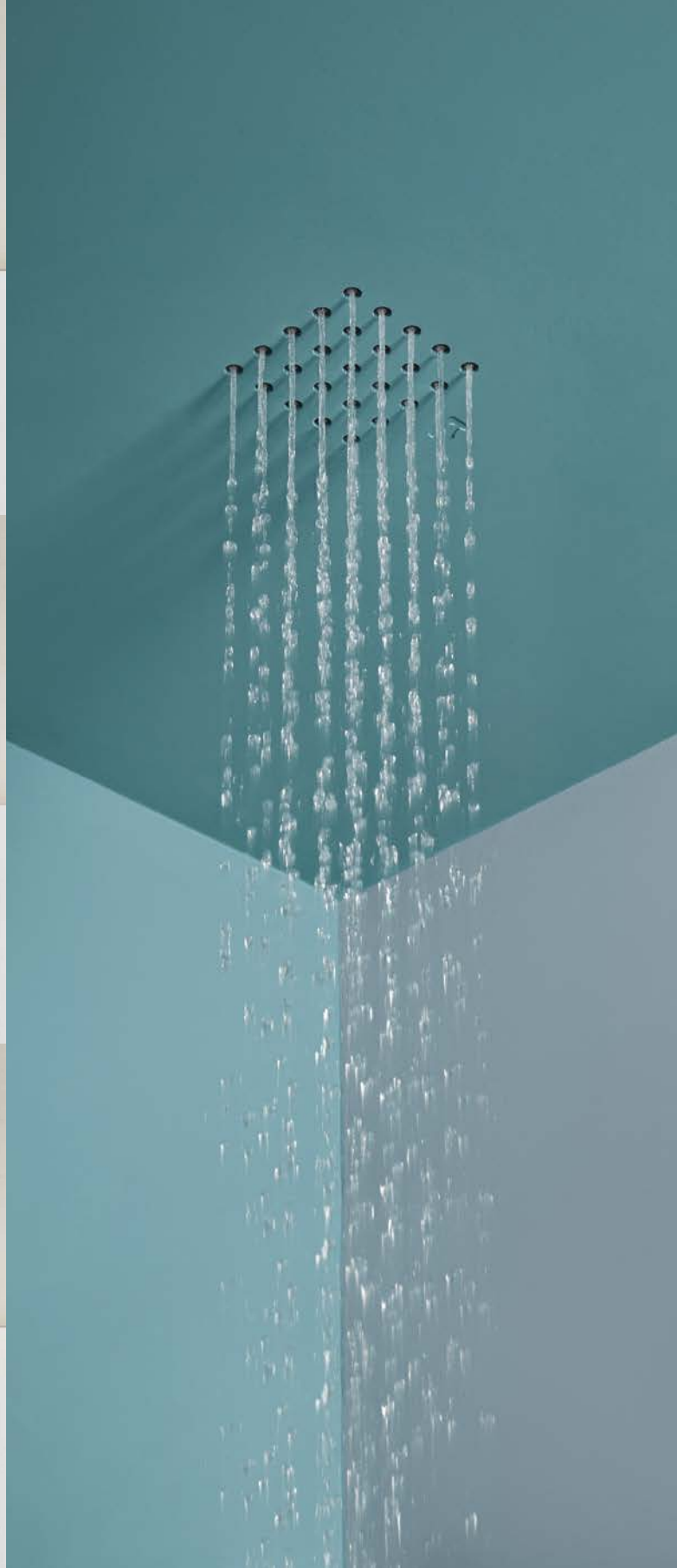

<i>h</i>	<i>p</i>	<i>l</i>	<i>art.</i>
3	25	20	GHOST

Soffione ad incasso a soffitto in Flumood con ugelli ispezionabili.

Encased ceiling shower head in Flumood with nozzles that can be inspected.

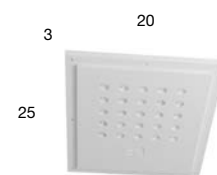

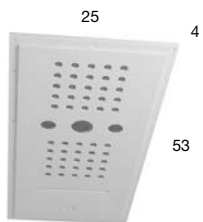
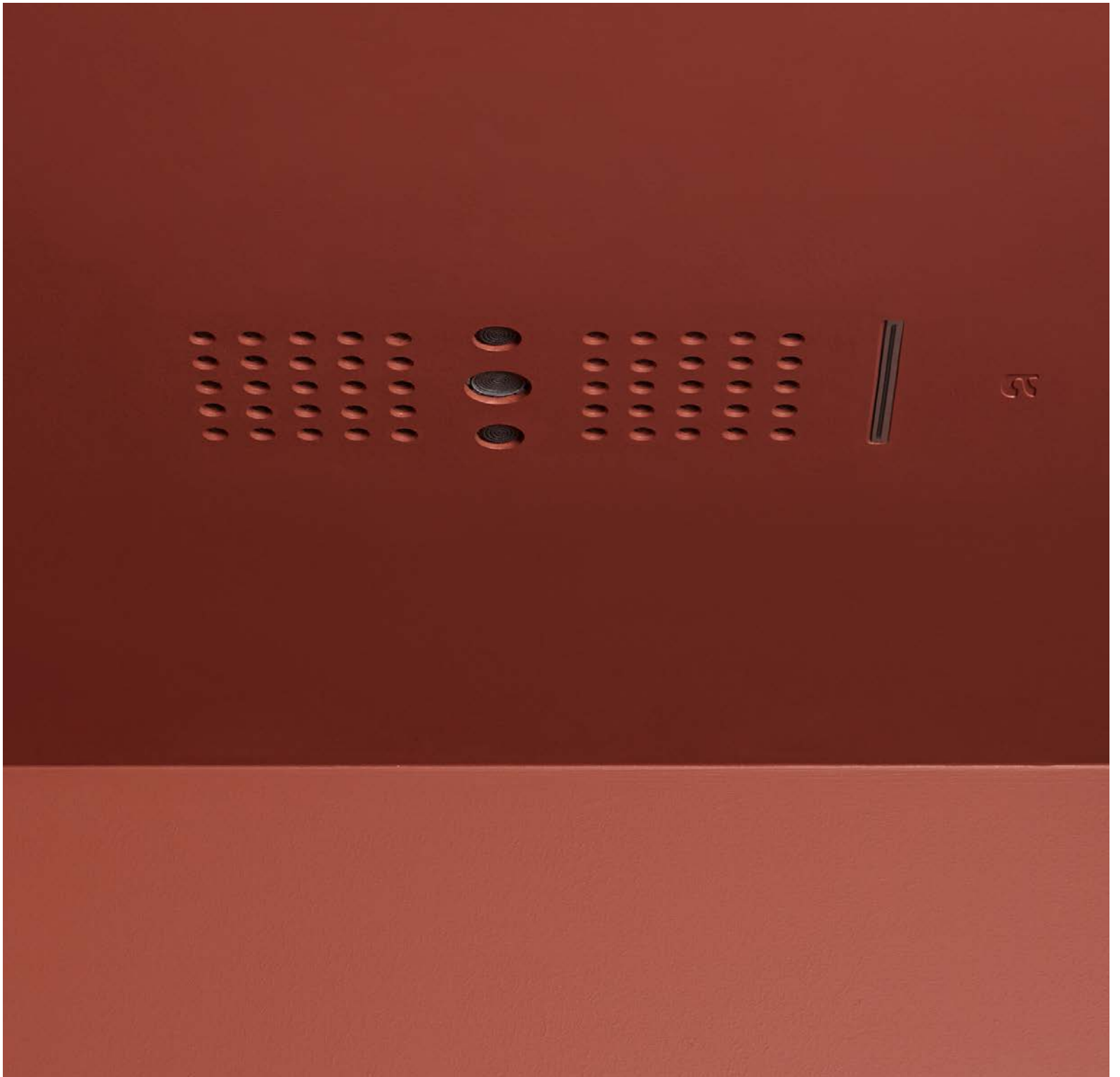

<i>h</i>	<i>p</i>	<i>l</i>	<i>art.</i>
4	53	25	GHOST_COMBI

Soffione ad incasso a soffitto con getto a chiodo, spray e cascata in Flumood con ugelli ispezionabili.

Encased ceiling showerhead in Flumood with nail, spray and waterfall jet and inspectable nozzles.

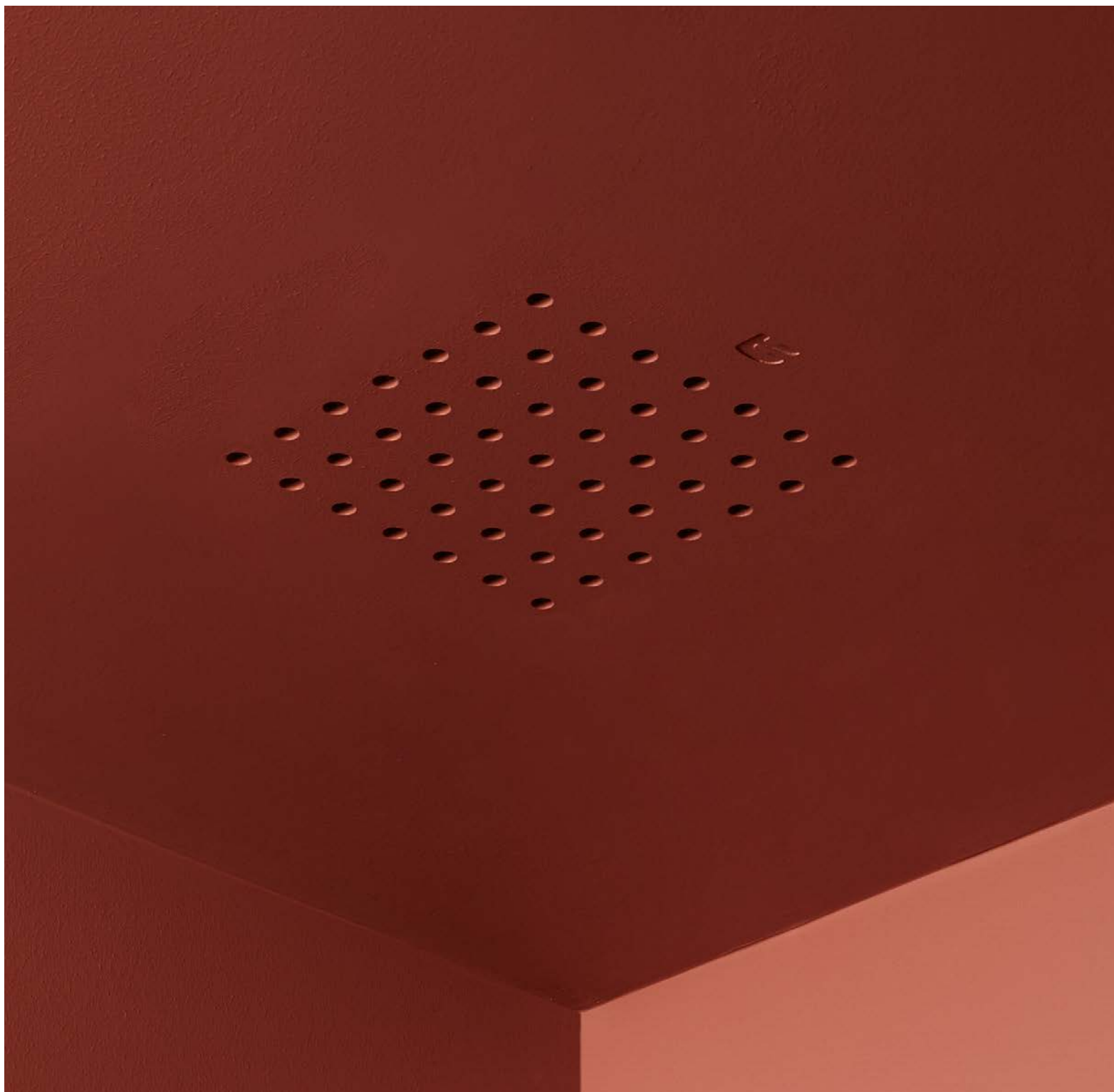

<i>h</i>	<i>p</i>	<i>l</i>	<i>art.</i>
3	35	30	GHOST_BIG

Soffione ad incasso a soffitto in Flumood con ugelli ispezionabili.

Encased ceiling showerhead in Flumood with nozzles that can be inspected.

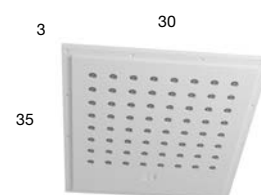

RAINDROP

2019

design_Calvi Brambilla

L'eleganza di un segno che rimanda a uno dei fenomeni più conosciuti della natura, l'eccellenza tecnologica che permette di riprodurre perfettamente l'immagine, il pensiero creativo dell'uomo che ne estrapola l'essenza e la ripropone in maniera inedita, straniante, ribaltandone la percezione.

Raindrop è tutto questo, è un soffione integrato a soffitto che riproduce l'immagine dell'effetto generato da una goccia di pioggia che colpisce la superficie dell'acqua. I delicati cerchi concentrici che si sviluppano con un'intensità sempre minore allontanandosi dal centro, descrivono un segno sofisticato sul soffitto, un decoro naturale che avvolge e protegge il soffione da incasso.

Perfetto nella sua pulizia assoluta, Raindrop è realizzato in Flumood e può essere perfettamente integrato anche cromaticamente nel soffitto al quale conferisce un'inaspettata tridimensionalità, identificando, o meglio valorizzando, lo spazio doccia e wellness.

Con Raindrop, antoniolupi prosegue nel percorso di ricerca sul tema dei soffioni integrati a soffitto, sistemi nei quali la componente tecnologica viene celata e nascosta alla vista e il soffione viene di fatto annegato nel controsoffitto in maniera perfetta.

Soluzioni nelle quali l'attenzione al dettaglio è ancora più importante, proposte che esprimono al meglio la sartorialità di antoniolupi e la costante ricerca di un ambiente bagno esclusivo.

The elegance of an indication that refers to one of the most well-known phenomena of nature, the technological excellence that allows us to perfectly reproduce the image, the creative thought of the man who takes the essence and proposes it in a new alienating way, overturning the perception.

Raindrop is all this, it is a showerhead integrated in the ceiling that reproduces the image of the effect generated by a drop of rain that hits the surface of the water.

The delicate concentric circles that evolve with less intensity while moving away from the center, portray a sophisticated sign on the ceiling, a natural decoration that wraps and protects the built-in showerhead.

Perfect in its absolute cleanliness, Raindrop is made of Flumood and can be perfectly integrated in the ceiling to which it gives an unexpected three-dimensionality, identifying, or better enhancing, the shower and wellness area.

With Raindrop, antoniolupi continues on the path of researching integrated ceiling showerhead systems in which the technological component is hidden and the showerhead is in fact drowned perfectly in the false ceiling.

Solutions in which attention to detail is even more important, proposals that best express the tailoring of antoniolupi and the constant search for an exclusive bathroom environment.



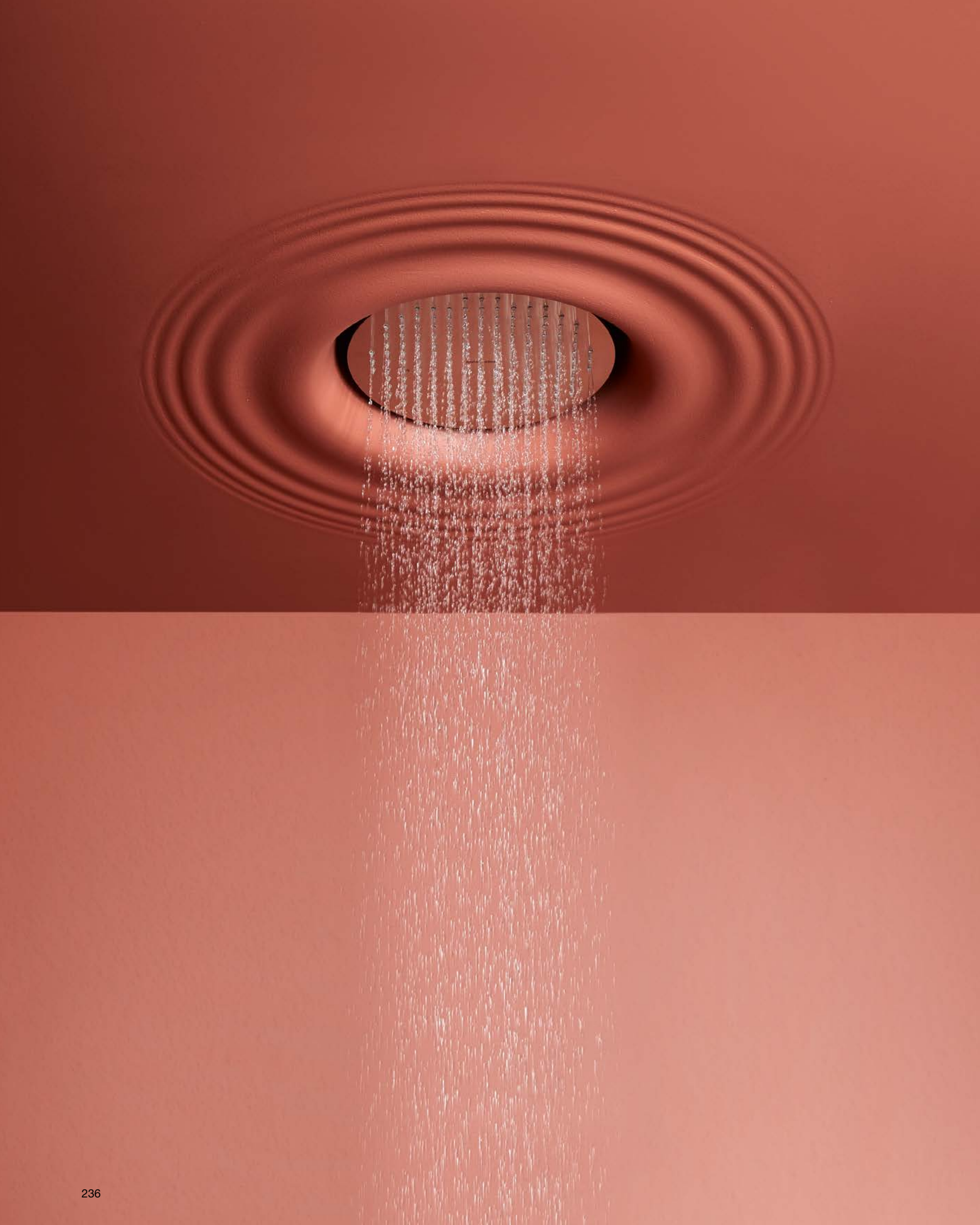

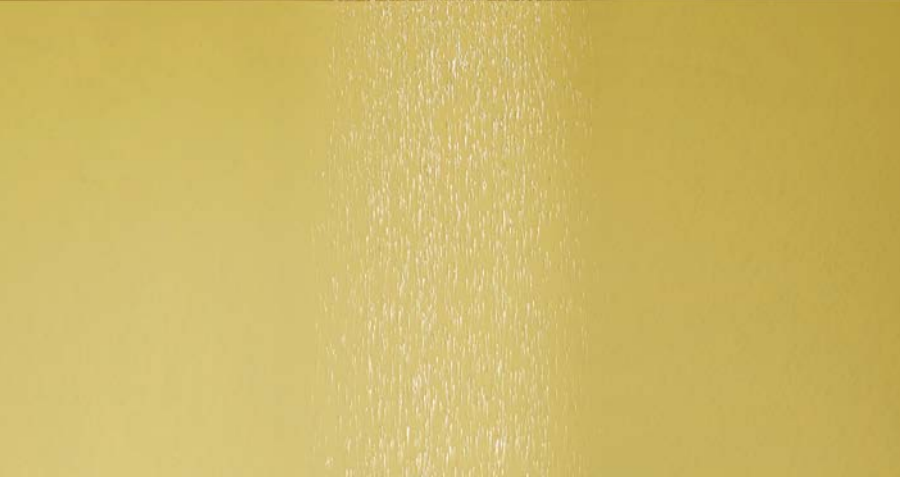









<i>h</i>	<i>p</i>	<i>l</i>	<i>art.</i>
11	70	70	RAINDROP

Struttura ad incasso a soffitto in Flumood con soffione in acciaio inox satinato AISI 304.

Ceiling encased Flumood frame with satin stainless steel AISI 304 showerhead.

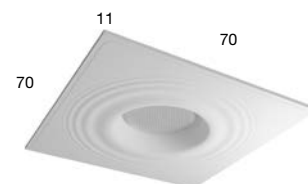

IRIDE

2017

design_Marco Pisati

Emozione pura, benessere assoluto, ma anche massima funzionalità:

Iride è una lanterna luminosa dalla quale fuoriesce un getto rigenerante, è un sistema integrato di illuminazione e soffione a soffitto che cattura l'attenzione e diventa fulcro della composizione dell'ambiente bagno.

L'importante volume cilindrico, si smaterializza grazie al diffusore in acrilico opalino e al potente faretto LED provvisto anche di luce RGB per cromoterapia, collocato in posizione centrale.

Attorno ad esso, un soffione doccia ad anello avvolge la fonte luminosa e definisce un cono di luce potente e preciso.

Il getto viene così smaterializzato in molteplici colori, i guizzanti riflessi dell'acqua, percorrono lo spazio e sprigionano una forza rigenerante.

La diffusione della luce è uniforme in tutte le direzioni.

La geometria del diffusore non definisce infatti una gerarchia dei fronti, ma descrive una fonte di benessere attorno alla quale ruotano tutti i protagonisti della scena quotidiana.

Una luce vera, non solo d'effetto, uno strumento che illumina lo spazio e rigenera chi lo vive.

Pure emotion and absolute maximum functionality:

Iride is a bright lantern from which a regenerating jet integrated within catches your attention and becomes the fulcrum of any bathroom.

The important cylindrical volume is dematerialized thanks to the opal acrylic diffuser and to the powerful LED spotlight which also has RGB light for chromotherapy, placed in a central position.

Around it, a showerhead ring surrounds the light source and defines a powerful and precise beam of light.

The jet is so dematerialized in multiple colors, the rippling reflections of the water runs through the space and gives off a regenerating force.

The diffusion of light is uniform in all directions. The geometry of the diffuser describes a source of well-being.

A true light, not only the effect, an instrument that illuminates the space and regenerates those who experience it.







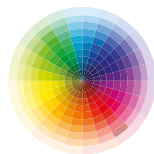

Tutti i soffioni con illuminazione a LED RGB sono dotati di telecomando waterproof IP66 che può essere utilizzato comodamente sotto la doccia.

All overhead showers with RGB LED lighting come with an IP66 waterproof remote control that can easily be used under the shower.



Ø 25

16

<i>h</i>	<i>ø</i>	<i>art.</i>
16	25	IRIDE_IN

Soffione a soffitto in acciaio inox satinato AISI 304, completo di diffusore in acrilico opalino e illuminazione a LED RGB comprensivo di telecomando waterproof.

Ceiling mount showerhead in stainless steel AISI 304, complete with matt acrylic light diffuser, led rgb lighting and waterproof remote control.



AZIMUT

2017

design_GI-RA

Modello e design registrato, brevetto depositato
Registered model and design, patent filed



CORPO NERO OPACO | CILINDRO ACCIAIO SATINATO AISI 304

MATT BLACK BODY | AISI 304 SATIN STEEL CYLINDER

Il corpo è compatto, le dimensioni sono insolitamente contenute, la potenza assoluta.

L'acqua fuoriesce con energia e vigore da un cilindro che rimanda per forma e dimensioni all'immagine di altri oggetti che popolano gli spazi domestici. Invece Azimut è un soffione da parete o da soffitto, che unisce tecnologia e rigore, un dispositivo complesso nel suo minimalismo pressoché assoluto, che permette di differenziare il getto e la sua direzione grazie a una ghiera metallica che ne regola la posizione.

Al corpo in nero opaco, si aggiunge la possibilità di personalizzare il cilindro in acciaio inox satinato, cromo lucido, grafite, ottone lucido e satinato o verniciato nella gamma cromatica di antoniolupi.

I colori pastello donano identità all'oggetto chiamato a dialogare con le texture e le tonalità della parete sulla quale viene installato.

The body is compact, the dimensions unusually small, the absolute power. The water comes out with energy and vigour from a cylinder whose shape and dimensions recall the image of other objects that populate domestic spaces.

Azimut, on the other hand, is a wall or ceiling-mounted showerhead that combines technology and rigour, a complex device in its almost absolute minimalism, which allows the jet and its direction to be differentiated thanks to a metal ring that adjusts its position.

In addition to the matt black body, the cylinder can be customized in satin stainless steel, polished chrome, graphite, polished and satin brass or lacquered in the antoniolupi colour range.

The pastel colours give identity to the object called to dialogue with the textures and shades of the wall on which it is installed.



AZIMUT

Al corpo in nero opaco, si aggiunge la possibilità di personalizzare il cilindro in acciaio inox satinato, cromo lucido, grafite, ottone lucido e satinato o verniciato opaco come da nostro campionario colori.

To the matt black body now you can customize the cylinder in satin stainless steel, polished chrome, graphite, polished and satin brass or matt lacquered as per our color samples.

SA Acciaio satinato AISI 304
Satin steel AISI304

OL Ottone lucido naturale
Natural polished brass

OS Ottone satinato naturale
Natural satin brass

GR Finitura grafite
Graphite finish

VO Verniciato opaco come da nostro campionario colori.
Matt lacquered as per our color samples.

LU Finitura cromo lucido
Polished Chrome finish





CORPO NERO OPACO | CILINDRO GRAFITE

MATT BLACK BODY | GRAPHITE CYLINDER



CORPO NERO OPACO | CILINDRO OTTONE SATINATO NATURALE

MATT BLACK BODY | NATURAL SATIN BRASS CYLINDER



CORPO NERO OPACO | CILINDRO NERO OPACO
MATT BLACK BODY | MATT "NERO" CYLINDER



CORPO NERO OPACO | CILINDRO BIANCO OPACO
MATT BLACK BODY | MATT "BIANCO" CYLINDER



CORPO NERO OPACO | CILINDRO COCCODRILLO OPACO
MATT BLACK BODY | MATT "COCCODRILLO" CYLINDER



CORPO NERO OPACO | CILINDRO TERRACOTTA OPACO
MATT BLACK BODY | MATT "TERRACOTTA" CYLINDER



CORPO NERO OPACO | CILINDRO LAMBRETTA OPACO
MATT BLACK BODY | MATT "LAMBRETTA" CYLINDER

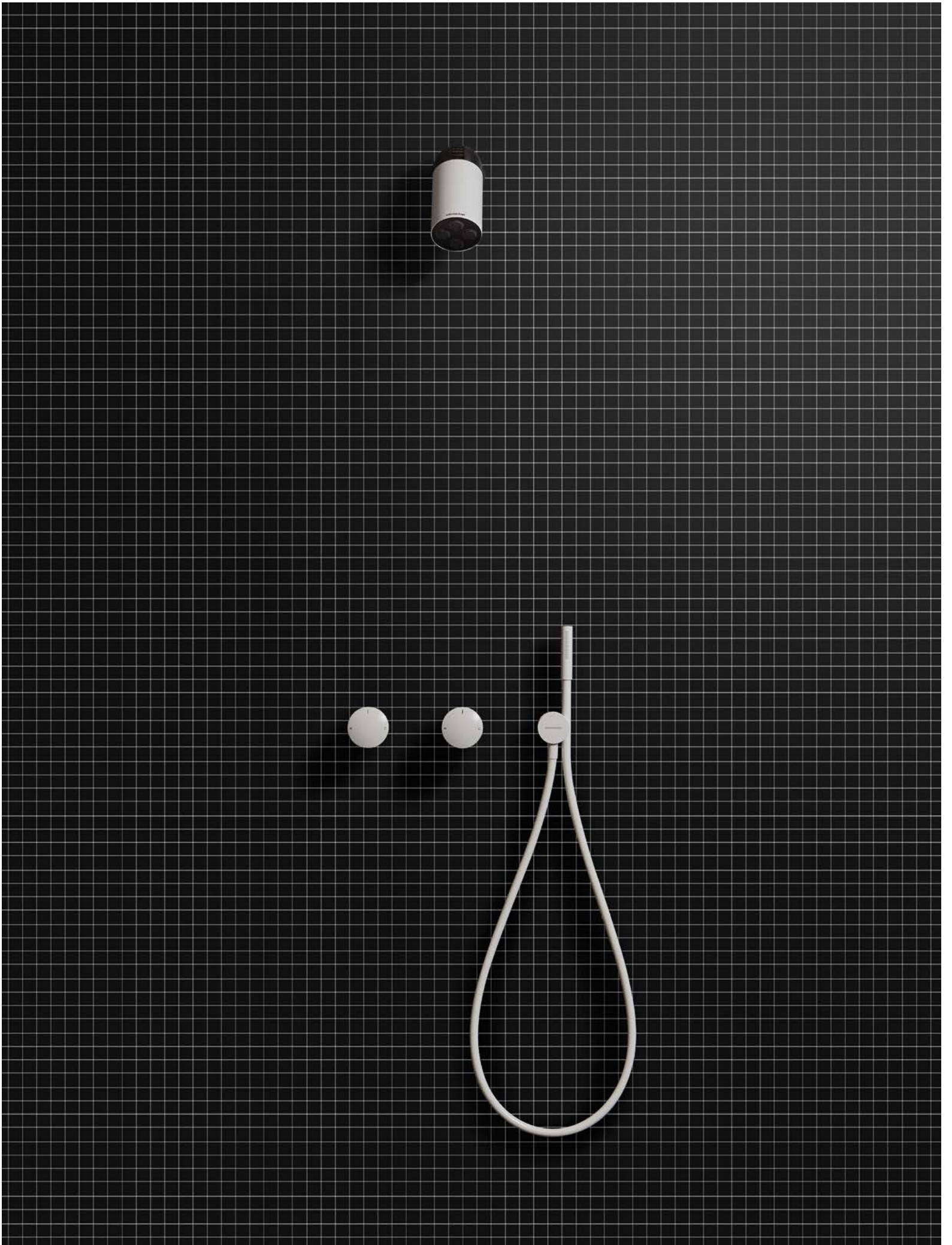



CORPO NERO OPACO | CILINDRO BIANCO OPACO

MATT BLACK BODY | MATT "BIANCO" CYLINDER

<i>h</i>	<i>p</i>	<i>ø</i>	<i>art.</i>
9	17,5	8	AZIMUT

Soffione a parete o a soffitto in acciaio inox e corpo nero opaco, con cilindro nelle finiture disponibili, regolazione del getto.

Wall or ceiling showerhead in stainless steel and body matt black, with cylinder in the available finishes, the jet can also be regulated.

