

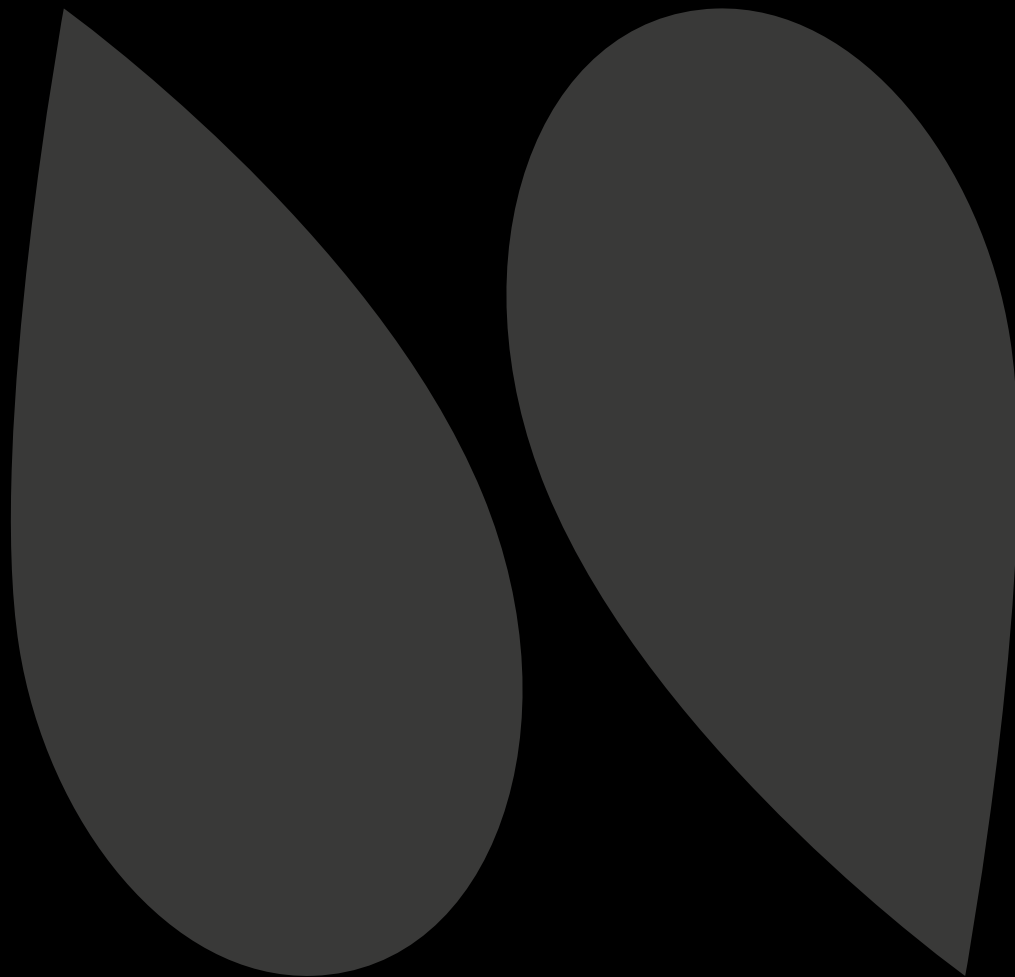

**+9%**  
BOX DOCCIA - PARETI DOCCIA  
PARETI VASCA - MOBILI

**+12%**  
ALTRI PRODOTTI



# NEWS **2022**



[WWW.NOVELLINI.COM](http://WWW.NOVELLINI.COM)





Drop is life  
Visita il sito dedicato all'impegno Green del gruppo Novellini

green

è molto più che un colore:  
è responsabilità

La responsabilità di prendere decisioni e fare investimenti oculati. Cerchiamo infatti di garantire compatibilità e sostenibilità tra iniziative economiche ed esigenze ambientali, tra ricerca e strumenti tecnologici in nostro possesso. Puntiamo al miglioramento dei prodotti dal punto di vista ecologico senza comprometterne qualità, funzionalità e durata.





## BOX DOCCIA

07 ZEPHYROS 2.0



## PIATTI DOCCIA

33 NOVOMATT  
35 OLYMPIC PLUS  
37 OLYMPIC



## COLONNE DOCCIA

40 F  
41 Z



## CABINE

45 MEDIA GLASS



## VASCHE

57 STILE  
63 SENSE 2.0  
69 DIVINA W



## COMPLEMENTI

79 ACCESSORI FRAME  
87 ACCESSORI EDGE

# Investimenti continui in ricerca e sviluppo

In Novellini una parte fondamentale delle attività svolte è rivolta al continuo miglioramento dei propri prodotti.

La forte esperienza consolidata in oltre 50 anni di continua ricerca e sviluppo ha guidato gli investimenti orientandoli nella creazione di soluzioni di design aderenti alle evoluzioni di un mercato sempre più esigente.

Questo ci permette di presentarci con una gamma prodotti ampia e profonda per il tuo benessere quotidiano.

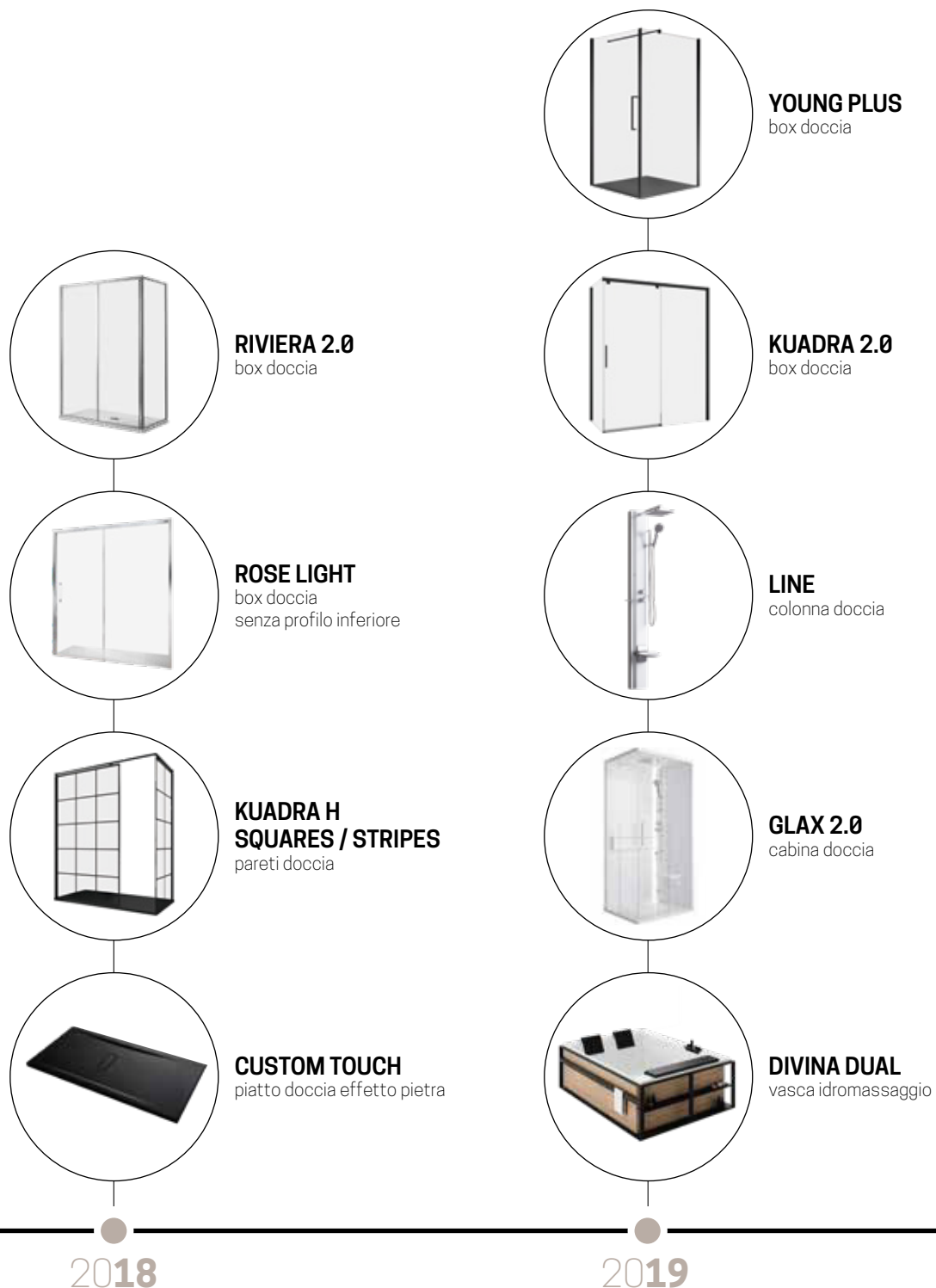





**ZEPHYROS 2.0**  
box doccia



**MEDIA GLASS**  
cabina doccia

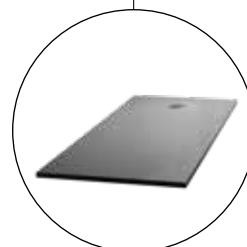

**NOVOMATT**  
piatto doccia

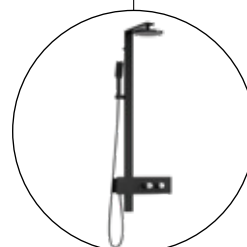

**F/Z**  
colonne doccia



**FRAME COLLECTION**  
pareti doccia e accessori

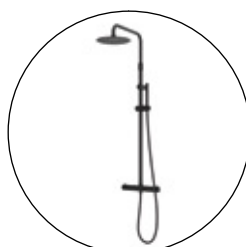

**EASY 2R**  
colonna doccia

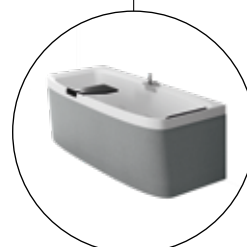

**DIVINA W**  
vasca

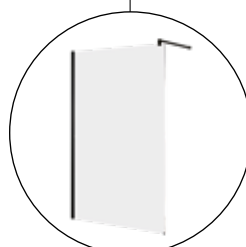

**EDGE COLLECTION**  
pareti doccia e accessori



**OUTDOOR SPA**  
minipiscine da esterno

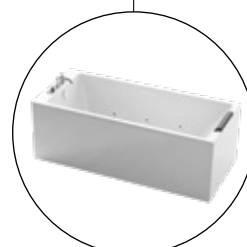

**STILE**  
vasca



**INFINITIVE / SHIP**  
vasca



**OUTDOOR SPA**  
complementi da esterno

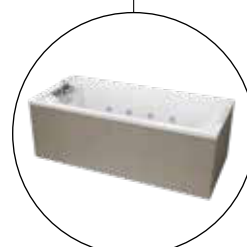

**SENSE 2.0**  
vasca

2020

2021

2022





# Box doccia



Una soluzione perfetta per ogni desiderio, esigenza, gusto.



## Sgancio montato reversibile

Un piccolo dettaglio a garanzia di un'efficace funzionalità. La presenza dello sgancio assicura facilità di pulizia e manutenzione.



## Rapidità d'installazione

Tecniche progettuali valorizzano l'adattabilità del box doccia in fase di installazione.

Lo sgancio montato rende più veloce l'installazione perché non richiede nessun intervento da parte dell'installatore.

# ZEPHYROS 2.0

INFINITE COMPOSIZIONI  
DI BENESSERE.



◀ Nuova maniglia



◀ Reversibile  
(tranne per modelli PH / AH)



◀ Nuovo sgancio ante  
(per modelli PH / AH)



## TRATTAMENTI







# ZEPHYROS 2.0

# ZEPHYROS 2.0 2P



**PORTA DOCCIA APERTURA 1 ANTA SCORREVOLE E 1 FISSA IN LINEA**  
 ANTE SGANCIABILI PER UNA FACILE PULIZIA

Misure			Codice	Scelta vetro				Scelta profilo			
Misura effettiva d'ingombro	Fisso	Entrata (cm)		1	4	11	91	U	B	K	H
<b>A</b>	<b>F1</b>	<b>*</b>		Trasparente	Satin	Niva	Serigrafia Strip	Bianco opaco	Silver	Cromo	Nero opaco
96↔102	44	37	<b>ZEP22P96-</b>								
114↔120	53	46	<b>ZEP22P114-</b>								
116↔122	54	47	<b>ZEP22P116-</b>								
126↔132	59	52	<b>ZEP22P126-</b>								
136↔142	64	57	<b>ZEP22P136-</b>								
146↔152	69	62	<b>ZEP22P146-</b>								
156↔162	74	67	<b>ZEP22P156-</b>								
166↔172	79	72	<b>ZEP22P166-</b>								
H 160↓200 L 96↔166	SPECIAL		<b>ZEP22PSP</b>								

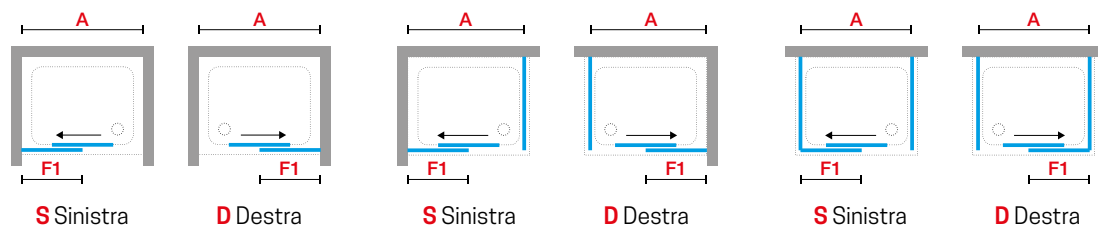
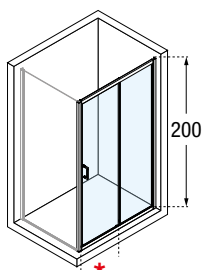



DISPONIBILITÀ MARZO 2022

ZEPHYROS 2.0

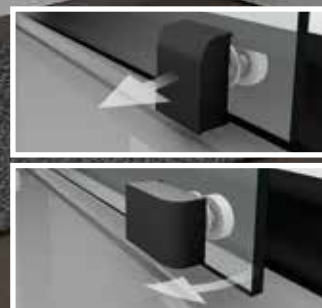

SGANCIO MONTATO  
E REVERSIBILE

#### FINITURE VETRI



Traspirente  
cod 1

Satin  
cod 4

Niva  
cod 11

Strip  
cod 91

#### FINITURE PROFILI



Bianco opaco  
cod U

Silver  
cod B

Cromo  
cod K

Nero opaco  
cod H

# ZEPHYROS 2.0 A



**BOX DOCCIA AD ANGOLO APERTURA 2 ANTE SCORREVOLI E 2 FISSE IN LINEA**  
 ANTE SGANCIABILI PER UNA FACILE PULIZIA

Misure			Codice	Scelta vetro				Scelta profilo			
Misura effettiva d'ingombro	Fisso	Entrata (cm)		1	4	11	91	U	B	K	H
<b>A</b>	<b>F1</b>	*		Trasparente	Satin	Niva	Serigrafia Strip	Bianco opaco	Silver	Cromo	Nero opaco
67↔70	30	34	<b>ZEP2A67L-</b>								
72↔75	33	37	<b>ZEP2A72L-</b>								
74↔77	34	39	<b>ZEP2A74L-</b>								
77↔80	35	41	<b>ZEP2A77L-</b>								
82↔85	38	44	<b>ZEP2A82L-</b>								
87↔90	40	48	<b>ZEP2A87L-</b>								
92↔95	43	51	<b>ZEP2A92L-</b>								
97↔100	45	55	<b>ZEP2A97L-</b>								
102↔105	48	59	<b>ZEP2A102L-</b>								
107↔110	50	62	<b>ZEP2A107L-</b>								
112↔115	53	66	<b>ZEP2A112L-</b>								
117↔120	55	69	<b>ZEP2A117L-</b>								

**PER COMPORRE UN ANGOLO ORDINARE 2 LATI.**  
**POSSIBILITÀ DI ORDINARE UN PANNELLO FISSO LATERALE PER AVERE 3 LATI**

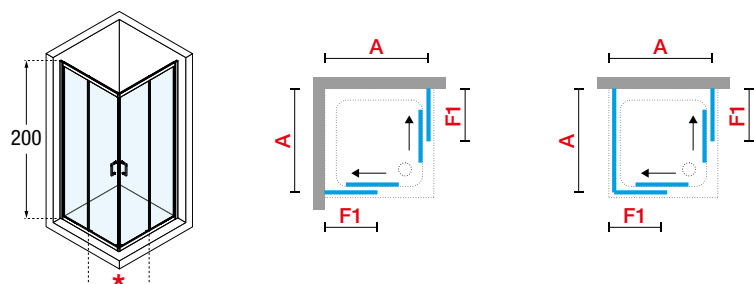



DISPONIBILITÀ MARZO 2022

ZEPHYROS 2.0

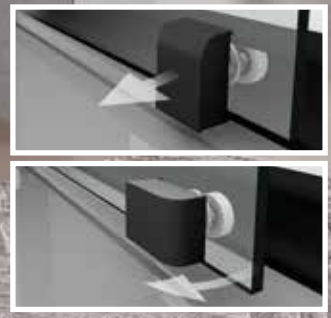

SGANCIO MONTATO  
E REVERSIBILE

FINITURE VETRI



Trasparente  
**cod 1**

Satin  
**cod 4**

Niva  
**cod 11**

Strip  
**cod 91**

FINITURE PROFILI



Bianco opaco  
**cod U**

Silver  
**cod B**

Cromo  
**cod K**

Nero opaco  
**cod H**

# ZEPHYROS 2.0 PH+FH



**BOX DOCCIA, APERTURA 1 ANTA SCORREVOLE E 1 ANTA FISSA IN LINEA CON 1 PARETE FISSA LATERALE**

ANTE SGANCIABILI PER UNA FACILE PULIZIA

Misure			Codice	Destra	Sinistra	Scelta vetro				Scelta profilo			
Misura effettiva d'ingombro	Fisso	Entrata (cm)		D-	S-	1	4	11	91	U	B	K	H
<b>A</b>	<b>F1</b>	*				Trasparente	Satin	Niva	Serigrafia Strip	Bianco opaco	Silver	Cromo	Nero opaco

## PORTA

96↔99	48	39	<b>ZEP2PH96</b>	D-	S-								
114↔117	57	48	<b>ZEP2PH114</b>	D-	S-								
116↔119	58	49	<b>ZEP2PH116</b>	D-	S-								
126↔129	63	54	<b>ZEP2PH126</b>	D-	S-								
136↔139	68	59	<b>ZEP2PH136</b>	D-	S-								
146↔149	73	64	<b>ZEP2PH146</b>	D-	S-								
156↔159	78	69	<b>ZEP2PH156</b>	D-	S-								
166↔169	83	74	<b>ZEP2PH166</b>	D-	S-								

H 160↓200 L 96↔166 SPECIAL **ZEP2PHSP** -

## PARETE FISSA REVERSIBILE

67↔70	-	-	<b>ZEP2FH67-</b>										
73↔76	-	-	<b>ZEP2FH73-</b>										
77↔80	-	-	<b>ZEP2FH77-</b>										
87↔90	-	-	<b>ZEP2FH87-</b>										
97↔100	-	-	<b>ZEP2FH97-</b>										
117↔120	-	-	<b>ZEP2FH117-</b>										

H 160↓200 L 20↔117 SPECIAL **ZEP2FHSP** -

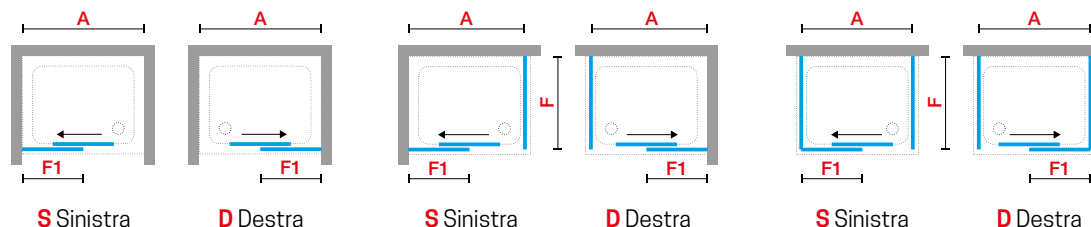
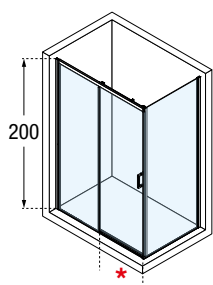

DISPONIBILITÀ MARZO 2022

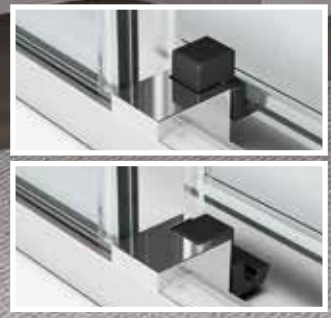

SGANCIO MONTATO

**FINITURE VETRI**



Traspacente  
cod 1

Satin  
cod 4

Niva  
cod 11

Strip  
cod 91

**FINITURE PROFILI**



Bianco opaco  
cod U

Silver  
cod B

Cromo  
cod K

Nero opaco  
cod H

# ZEPHYROS 2.0 AH



**BOX DOCCIA AD ANGOLO APERTURA 2 ANTE SCORREVOLI E 2 FISSE**  
 ANTE SGANCIABILI PER UNA FACILE PULIZIA

Misure			Codice	Destra	Sinistra	Scelta vetro				Scelta profilo			
Misura effettiva d'ingombro	Fisso	Entrata (cm)				1	4	11	91	U	B	K	H
<b>A</b>	<b>F1</b>	*		D-	S-	Trasparente	Satin	Niva	Serigrafia Strip	Bianco opaco	Silver	Cromo	Nero opaco
67↔70	30	34	<b>ZEP2AH67L</b>	D-	S-								
72↔75	33	37	<b>ZEP2AH72L</b>	D-	S-								
74↔77	34	39	<b>ZEP2AH74L</b>	D-	S-								
77↔80	35	41	<b>ZEP2AH77L</b>	D-	S-								
82↔85	38	44	<b>ZEP2AH82L</b>	D-	S-								
87↔90	40	48	<b>ZEP2AH87L</b>	D-	S-								
92↔95	43	51	<b>ZEP2AH92L</b>	D-	S-								
97↔100	45	55	<b>ZEP2AH97L</b>	D-	S-								
102↔105	48	59	<b>ZEP2AH102L</b>	D-	S-								
107↔110	50	62	<b>ZEP2AH107L</b>	D-	S-								
112↔115	53	66	<b>ZEP2AH112L</b>	D-	S-								
117↔120	55	69	<b>ZEP2AH117L</b>	D-	S-								

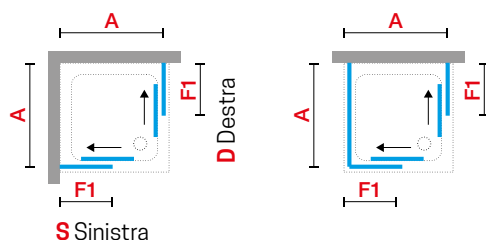
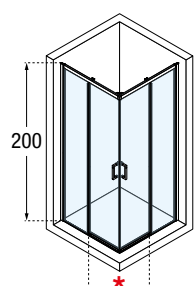

Costruzione del codice

**Codice** + **Vetro** + **Profilo** = Codice prodotto finale



DISPONIBILITÀ MARZO 2022

ZEPHYROS 2.0

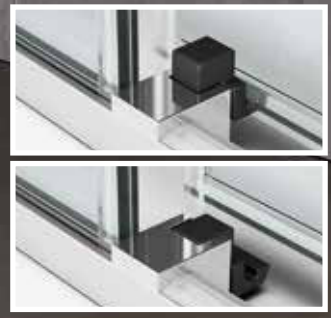

SGANCIO MONTATO

FINITURE VETRI



Trasparente  
cod 1

Satin  
cod 4

Niva  
cod 11

Strip  
cod 91

FINITURE PROFILI



Bianco opaco  
cod U

Silver  
cod B

Cromo  
cod K

Nero opaco  
cod H

# ZEPHYROS 2.0 G



## PORTA DOCCIA, APERTURA 1 ANTA BATTENTE

Misure			Codice	Scelta vetro					Scelta profilo			
Misura effettiva d'ingombro	Ingombro anta esterno	Entrata (cm)		1	4	11	91	82	U	B	K	H
<b>A</b>	<b>B</b>	<b>*</b>		Trasparente	Satin	Niva	Serigrafia Strip	Stripes	Bianco opaco	Silver	Cromo	Nero opaco
66↔72	54	54	<b>ZEP2G66-</b>									
72↔78	60	60	<b>ZEP2G72-</b>									
76↔82	64	64	<b>ZEP2G76-</b>									
86↔92	74	74	<b>ZEP2G86-</b>									
96↔102	84	84	<b>ZEP2G96-</b>									
H 160↓200 L 66↔96	SPECIAL		<b>ZEP2GSP</b>									

## ZEPHYROS 2.0 F STRIPES

Misure	Codice	Scelta vetro	Scelta profilo
Misura effettiva d'ingombro		<b>82</b>	<b>H</b>
<b>F</b>		Stripes	Nero opaco
66↔69	<b>ZEP2FN66-</b>		
68↔71	<b>ZEP2FN68-</b>		
73↔76	<b>ZEP2FN73-</b>		
76↔79	<b>ZEP2FN76-</b>		
78↔81	<b>ZEP2FN78-</b>		
83↔86	<b>ZEP2FN83-</b>		
88↔91	<b>ZEP2FN88-</b>		
93↔96	<b>ZEP2FN93-</b>		
98↔101	<b>ZEP2FN98-</b>		
118↔121	<b>ZEP2FN118-</b>		

**LA SERIGRAFIA STRIPES VA ABBINATA SOLO CON PROFILO NERO OPACO PER I FISSI DI ALTRE FINITURE VEDI ZEPHYROS 2.0 F (PAG. 23)**

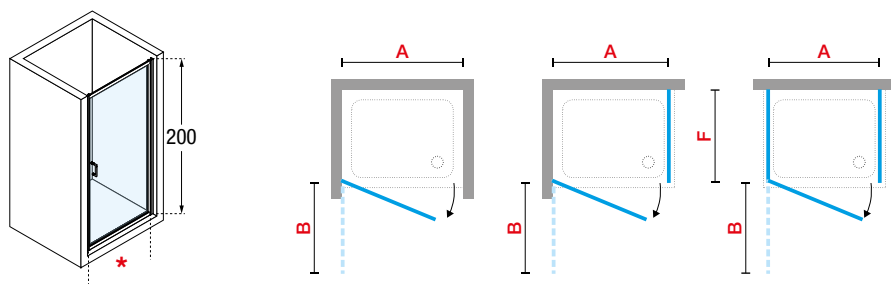

DISPONIBILITÀ MARZO 2022

ZEPHYROS 2.0



VERSIONE  
SERIGRAFIA STRIPES

FINITURE VETRI



Traspacente cod 1    Satin cod 4    Niva cod 11    Strip cod 91    Stripes cod 82

FINITURE PROFILI



Bianco opaco cod U    Silver cod B    Cromo cod K    Nero opaco cod H

# ZEPHYROS 2.0 2B

PORTA DOCCIA, APERTURA 2 ANTE BATTENTI



200 cm



6 mm



6 cm



## FINITURE VETRI

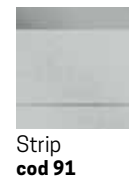

## FINITURE PROFILI



Misure			Codice	Scelta vetro				Scelta profilo			
Misura effettiva d'ingombro	Ingombro anta esterno	Entrata (cm)		1	4	11	91	U	B	K	H
<b>A</b>	<b>B</b>	*		Trasparente	Satin	Niva	Serigrafia Strip	Bianco opaco	Silver	Cromo	Nero opaco
66↔72	26	55	<b>ZEP22B66-</b>								
72↔78	29	61	<b>ZEP22B72-</b>								
76↔82	31	65	<b>ZEP22B76-</b>								
86↔92	36	75	<b>ZEP22B86-</b>								
96↔102	41	85	<b>ZEP22B96-</b>								

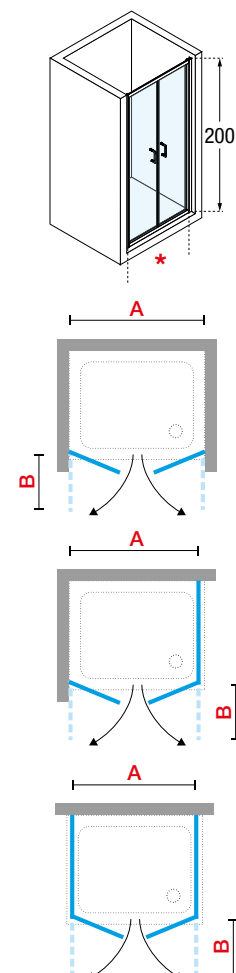



# ZEPHYROS 2.0 S IN OUT

PORTA DOCCIA, 2 ANTE A SOFFIETTO CON APERTURA DI SICUREZZA



200 cm



6 mm



6 cm



DISPONIBILITÀ MARZO 2022

## FINITURE VETRI



Trasparente  
cod 1

Satin  
cod 4

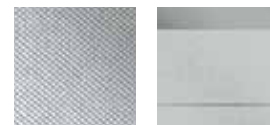

Niva  
cod 11

Strip  
cod 91

## FINITURE PROFILI



Bianco opaco  
cod U

Silver  
cod B



Cromo  
cod K

Nero opaco  
cod H

Misure			Codice	Scelta vetro				Scelta profilo			
Misura effettiva d'ingombro	Ingombro anta esterno	Entrata (cm)		1	4	11	91	U	B	K	H
<b>A</b>	<b>B</b>	<b>*</b>		Trasparente	Satin	Niva	Serigrafia Strip	Bianco opaco	Silver	Cromo	Nero opaco
66↔72	31	46	<b>ZEP2S266-</b>								
72↔78	34	52	<b>ZEP2S272-</b>								
76↔82	36	56	<b>ZEP2S276-</b>								
86↔92	41	66	<b>ZEP2S286-</b>								
96↔102	46	76	<b>ZEP2S296-</b>								

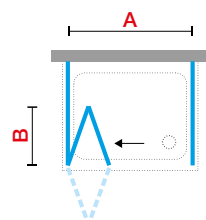
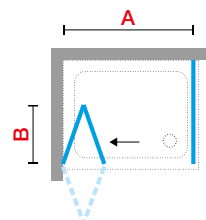
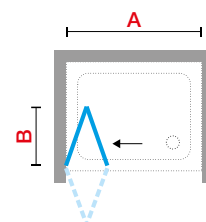
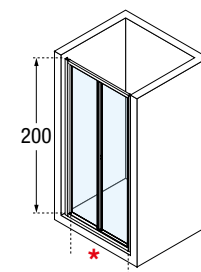

### APERTURA DI SICUREZZA.

**ATTENZIONE: L'APERTURA VERSO L'ESTERNO DEVE ESSERE CONSIDERATA SOLAMENTE COME APERTURA D'EMERGENZA**

Costruzione del codice **Codice** + **Vetro** + **Profilo** = Codice prodotto finale

# ZEPHYROS 2.0 3P



PORTA DOCCIA APERTURA 3 ANTE SCORREVOLI BILATERALE DA DESTRA E DA SINISTRA



DISPONIBILITÀ MARZO 2022

## FINITURE VETRI

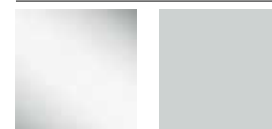

Trasparente  
cod 1

Satin  
cod 4

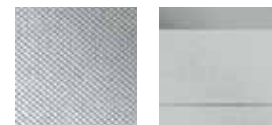

Niva  
cod 11

Strip  
cod 91

## FINITURE PROFILI



Bianco opaco  
cod U

Silver  
cod B



Cromo  
cod K

Nero opaco  
cod H

Misure		Codice	Scelta vetro				Scelta profilo			
Misura effettiva d'ingombro	Entrata (cm)		1	4	11	91	U	B	K	H
<b>A</b>	*		Trasparente	Satin	Niva	Serigrafia Strip	Bianco opaco	Silver	Cromo	Nero opaco
96↔102	41	<b>ZEP23P96-</b>								
106↔112	48	<b>ZEP23P106-</b>								
116↔122	54	<b>ZEP23P116-</b>								
126↔132	61	<b>ZEP23P126-</b>								
136↔142	68	<b>ZEP23P136-</b>								

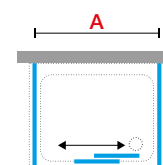
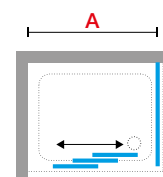
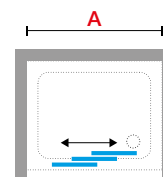
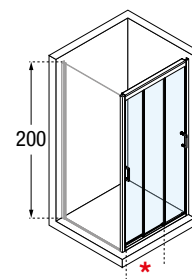

# ZEPHYROS 2.0 2A

PORTA DOCCIA APERTURA 2 ANTE SCORREVOLI E 2 FISSE IN LINEA



200 cm



6 mm



6 cm



DISPONIBILITÀ MARZO 2022

## FINITURE VETRI

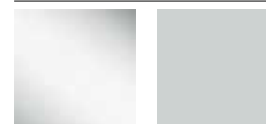

Trasparente  
cod 1

Satin  
cod 4

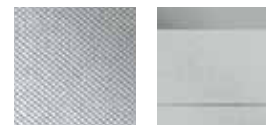

Niva  
cod 11

Strip  
cod 91

## FINITURE PROFILI



Bianco opaco  
cod U

Silver  
cod B



Cromo  
cod K

Nero opaco  
cod H

Misure			Codice	Scelta vetro				Scelta profilo			
Misura effettiva d'ingombro	Fisso	Entrata (cm)		1	4	11	91	U	B	K	H
<b>A</b>	<b>F1</b>	*		Trasparente	Satin	Niva	Serigrafia Strip	Bianco opaco	Silver	Cromo	Nero opaco
146↔152	35	54	<b>ZEP22A146-</b>								
156↔162	38	59	<b>ZEP22A156-</b>								
166↔172	40	64	<b>ZEP22A166-</b>								
176↔182	43	69	<b>ZEP22A176-</b>								
186↔192	48	69	<b>ZEP22A186-</b>								
196↔202	53	69	<b>ZEP22A196-</b>								

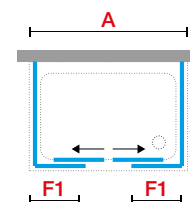
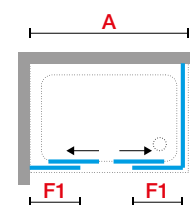
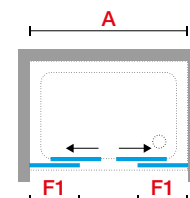
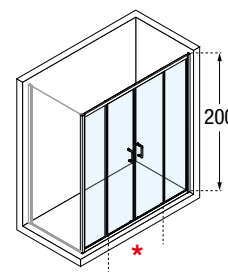

Costruzione del codice **Codice** + **Vetro** + **Profilo** = Codice prodotto finale

# ZEPHYROS 2.0 R



BOX DOCCIA AD ANGOLO SEMICIRCOLARE, APERTURA 2 ANTE SCORREVOLI E 2 FISSE



## FINITURE VETRI

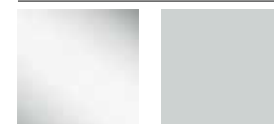

Trasparente  
cod 1

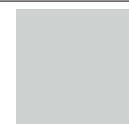

Satin  
cod 4



Niva  
cod 11



Strip  
cod 91

## FINITURE PROFILI



Bianco opaco  
cod U



Silver  
cod B



Cromo  
cod K



Nero opaco  
cod H

Misure			Codice	Scelta vetro				Scelta profilo			
Misura effettiva d'ingombro	Fisso	Entrata (cm)		1	4	11	91	U	B	K	H
<b>A</b>	<b>F1</b>	*		Trasparente	Satin	Niva	Serigrafia Strip	Bianco opaco	Silver	Cromo	Nero opaco
77,5↔80,5	24	42	<b>ZEP2R80-</b>								
87,5↔90,5	34	52	<b>ZEP2R90-</b>								
97,5↔100,5	44	52	<b>ZEP2R100-</b>								

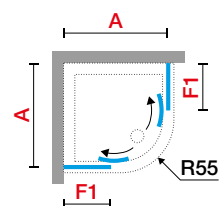
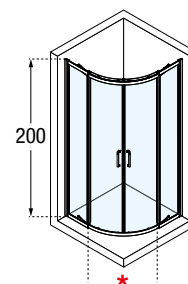



# ZEPHYROS 2.0 F

PARETE FISSA LATERALE



200 cm



6 mm



3 cm



ZEPHYROS 2.0



## FINITURE VETRI



Trasparente  
cod 1



Satin  
cod 4



Niva  
cod 11



Strip  
cod 91

## FINITURE PROFILI



Bianco opaco  
cod U



Silver  
cod B



Cromo  
cod K



Nero opaco  
cod H

Misure	Codice	Scelta vetro				Scelta profilo			
		1	4	11	91	U	B	K	H
Misura effettiva d'ingombro		Trasparente	Satin	Niva	Serigrafia Strip	Bianco opaco	Silver	Cromo	Nero opaco
<b>F</b>									
66↔69	<b>ZEP2F66-</b>								
68↔71	<b>ZEP2F68-</b>								
73↔76	<b>ZEP2F73-</b>								
76↔79	<b>ZEP2F76-</b>								
78↔81	<b>ZEP2F78-</b>								
83↔86	<b>ZEP2F83-</b>								
88↔91	<b>ZEP2F88-</b>								
93↔96	<b>ZEP2F93-</b>								
98↔101	<b>ZEP2F98-</b>								
118↔121	<b>ZEP2F118-</b>								

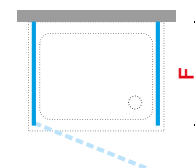
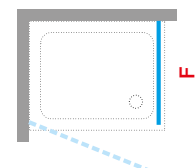
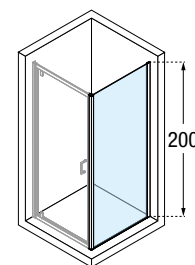

**PER LE SOLUZIONI CON DUE PANNELLI FISSI LATERALI  
UTILIZZARE SEMPRE 2 BARRE DI SOSTEGNO AD ANGOLO.**

Costruzione del codice + Codice + Vetro + Profilo = Codice prodotto finale

# ZEPHYROS 2.0 F SPECIAL 1

PARETE FISSA SPECIALE, SPECIALE IN LARGHEZZA



## FINITURE VETRI



Trasparente  
cod 1

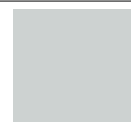

Satin  
cod 4



Niva  
cod 11

## FINITURE PROFILI



Bianco opaco  
cod U



Silver  
cod B



Cromo  
cod K



Nero opaco  
cod H

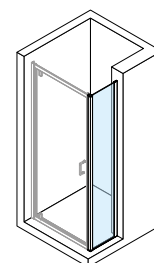

Misure	Codice	Scelta vetro			Scelta profilo			
Misura effettiva d'ingombro		<b>1</b>	<b>4</b>	<b>11</b>	<b>U</b>	<b>B</b>	<b>K</b>	<b>H</b>
<b>A</b>		Trasparente	Satin	Niva	Bianco opaco	Silver	Cromo	Nero opaco

H 150†200  
L 20↔118

**ZEP2F1SP**

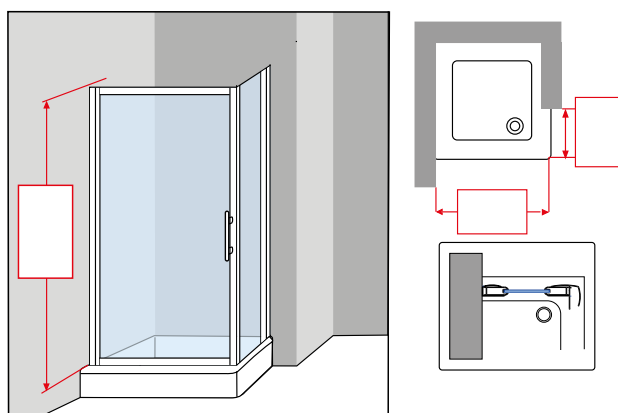

PER LA FATTIBILITÀ DELLE MISURE SPECIALI RIVOLGETEVI ALLA NOVELLINI O SU [HTTP://STORE.NOVELLINI.COM](http://store.novellini.com)



# ZEPHYROS 2.0 F SPECIAL 2

PARETE FISSA SPECIALE, SAGOMATA 5 LATI



6 mm



3 cm



## FINITURE VETRI



Trasparente  
cod 1

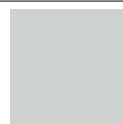

Satin  
cod 4



Niva  
cod 11

## FINITURE PROFILI



Bianco opaco  
cod U



Silver  
cod B



Cromo  
cod K



Nero opaco  
cod H

Misure	Codice	Scelta vetro			Scelta profilo			
Misura effettiva d'ingombro		<b>1</b>	<b>4</b>	<b>11</b>	<b>U</b>	<b>B</b>	<b>K</b>	<b>H</b>
<b>A</b>		Trasparente	Satin	Niva	Bianco opaco	Silver	Cromo	Nero opaco

H 155↕200  
L 60↔119

**ZEP2F2SP**

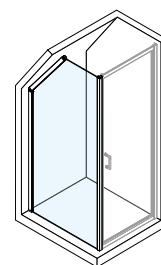

Sinistra

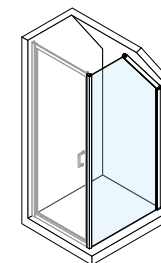

Destra

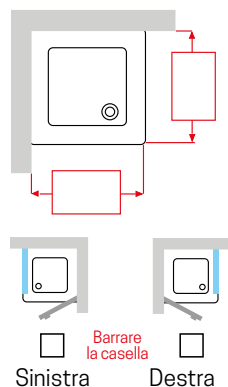
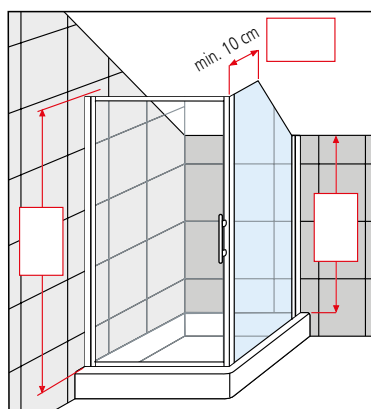

PER LA FATTIBILITÀ DELLE MISURE SPECIALI RIVOLGETEVI ALLA NOVELLINI O SU [HTTP://STORE.NOVELLINI.COM](http://store.novellini.com)

Costruzione del codice **Codice** + **Vetro** + **Profilo** = Codice prodotto finale

# ZEPHYROS 2.0 F SPECIAL 3

PARETE FISSA SPECIALE, SAGOMATA 6 LATI



6 mm



3 cm



DISPONIBILITÀ MARZO 2022



## FINITURE VETRI



Trasparente  
cod 1

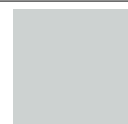

Satin  
cod 4



Niva  
cod 11

## FINITURE PROFILI



Bianco opaco  
cod U



Silver  
cod B



Cromo  
cod K



Nero opaco  
cod H

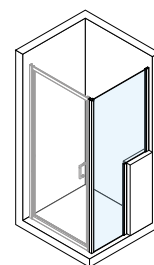

Misure	Codice	Scelta vetro			Scelta profilo			
Misura effettiva d'ingombro		<b>1</b>	<b>4</b>	<b>11</b>	<b>U</b>	<b>B</b>	<b>K</b>	<b>H</b>
<b>A</b>		Trasparente	Satin	Niva	Bianco opaco	Silver	Cromo	Nero opaco

H 140↕200  
L 60↔99

**ZEP2F3SP**

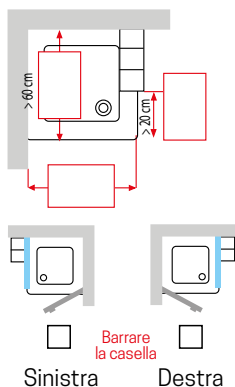
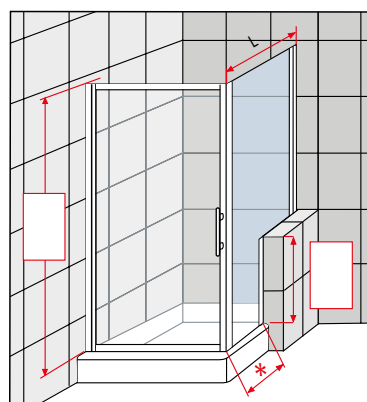

\*  $\geq L/3$ : LA QUOTA DI \* DEVE ESSERE MAGGIORE DI 1/3 DELLA LUCE SUPERIORE E COMUNQUE NON INFERIORE A 20 cm.

PER LA FATTIBILITÀ DELLE MISURE SPECIALI RIVOLGETEVI ALLA NOVELLINI O SU [HTTP://STORE.NOVELLINI.COM](http://store.novellini.com)





# ZEPHYROS 2.0 F SPECIAL 4

PARETE FISSA SPECIALE, PER INSTALLAZIONE SU MURETTO, SPECIALE IN LARGHEZZA ED ALTEZZA



6 mm



3 cm



DISPONIBILITÀ MARZO 2022

## FINITURE VETRI



Trasparente  
cod 1

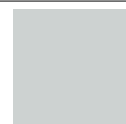

Satin  
cod 4



Niva  
cod 11

## FINITURE PROFILI



Bianco opaco  
cod U



Silver  
cod B



Cromo  
cod K



Nero opaco  
cod H

Misure	Codice	Scelta vetro			Scelta profilo			
Misura effettiva d'ingombro		<b>1</b>	<b>4</b>	<b>11</b>	<b>U</b>	<b>B</b>	<b>K</b>	<b>H</b>
<b>A</b>		Trasparente	Satin	Niva	Bianco opaco	Silver	Cromo	Nero opaco

H 25↕200  
L 20↔118

**ZEP2F4SP**

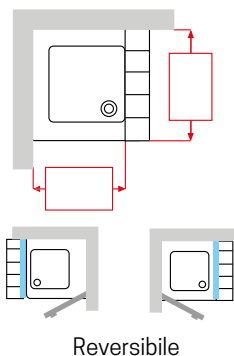
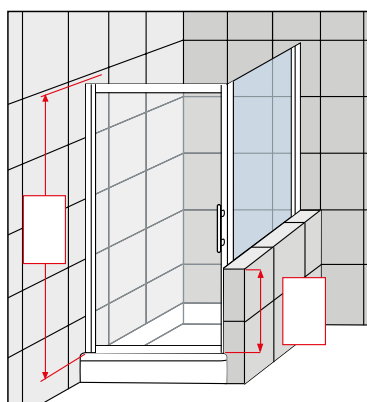
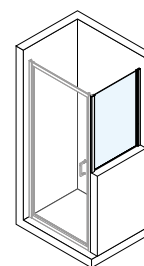

Reversibile

PER LA FATTIBILITÀ DELLE MISURE SPECIALI RIVOLGETEVI ALLA NOVELLINI O SU [HTTP://STORE.NOVELLINI.COM](http://store.novellini.com)

Costruzione del codice **Codice** + **Vetro** + **Profilo** = Codice prodotto finale

# ZEPHYROS 2.0 F SPECIAL 5



PARETE FISSA SPECIALE, IN LINEA / PARETE DIVISORIA / FISSAGGIO A MURO LATERALE / PROFILO CHIUSO

DISPONIBILITÀ MARZO 2022



FISSAGGIO IN LINEA



PARETE DIVISORIA



FISSAGGIO A MURO LATERALE



PROFILO CHIUSO

## FISSAGGIO IN LINEA

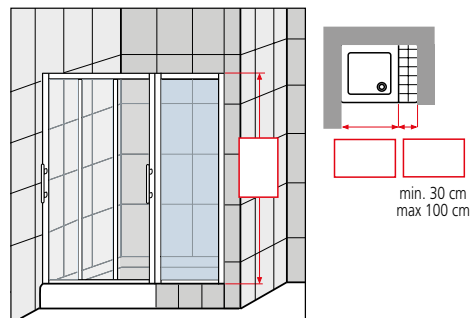

## PARETE DIVISORIA

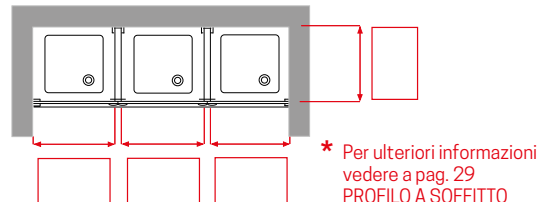
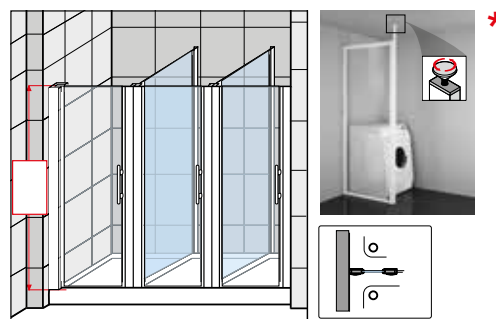

\* Per ulteriori informazioni vedere a pag. 29  
PROFILO A SOFFITTO

## FISSAGGIO A MURO LATERALE

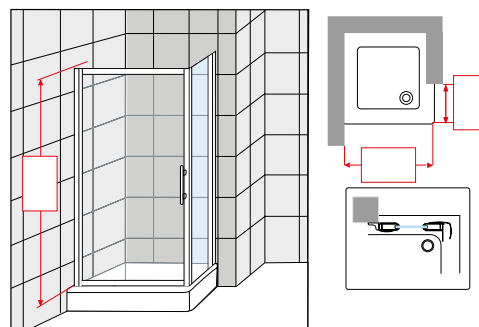

## PROFILO CHIUSO

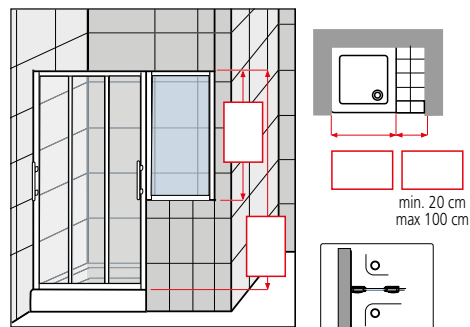

Misure	Codice	Scelta vetro			Scelta profilo			
		1	4	11	U	B	K	H
Misura effettiva d'ingombro								
<b>A</b>		Trasparente	Satin	Niva	Bianco opaco	Silver	Cromo	Nero opaco

### FISSI IN LINEA E PROFILI CHIUSI

H 25↔60	<b>ZEP2F5SP</b>							
H 60↔96	<b>ZEP2F5SP</b>							
H 96↔160	<b>ZEP2F5SP</b>							
H 160↔190	<b>ZEP2F5SP</b>							
H 190↔200	<b>ZEP2F5SP</b>							

### PARETE DIVISORIA

H 25↔60	<b>ZEP2F5SP</b>							
H 60↔96	<b>ZEP2F5SP</b>							
H 96↔160	<b>ZEP2F5SP</b>							
H 160↔190	<b>ZEP2F5SP</b>							
H 190↔200	<b>ZEP2F5SP</b>							

### FISSAGGIO LATERALE

H 25↔60	<b>ZEP2F5SP</b>							
H 60↔96	<b>ZEP2F5SP</b>							
H 96↔160	<b>ZEP2F5SP</b>							
H 160↔190	<b>ZEP2F5SP</b>							
H 190↔200	<b>ZEP2F5SP</b>							

PER LA FATTIBILITÀ DELLE MISURE SPECIALI RIVOLGETEVI ALLA NOVELLINI O SU [HTTP://STORE.NOVELLINI.COM](http://store.novellini.com)



## DATI TECNICI

### FINITURE PROFILI



Bianco opaco  
cod. U



Silver  
cod. B



Cromo  
cod. K



Nero opaco  
cod. H



### MANIGLIA



Maniglia

### VETRO TEMPRATO 6 mm (European Standards UNI EN 14428)



Trasparente  
cod. 1



Satin  
cod. 4

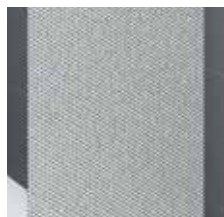

Niva  
cod. 11

### SERIGRAFIA



Strip  
cod. 91



Stripes  
cod. 82  
solo per modelli G - F

### OPTIONAL



#### BARRA DI SOSTEGNO AD ANGOLO

Finitura	Misure	Codice
Cromo	15 cm	<b>R80LOU150-K</b>
Bianco opaco		<b>R80LOU250-U</b>
Cromo	25 cm	<b>R80LOU250-K</b>
Nero opaco		<b>R80LOU250-H</b>
Bianco opaco		<b>R80LOU350-U</b>
Cromo	35 cm	<b>R80LOU350-K</b>
Nero opaco		<b>R80LOU350-H</b>
Bianco opaco		<b>R80LOU450-U</b>
Cromo	45 cm	<b>R80LOU450-K</b>
Nero opaco		<b>R80LOU450-H</b>

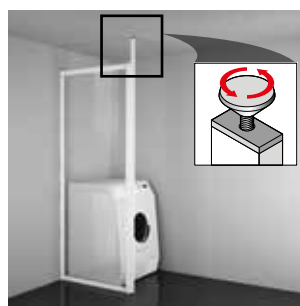

#### PROFILO A SOFFITTO

▪ Profilo speciale per fissaggio a soffitto da abbinare allo ZEP2F5SP

Finitura	Misure	Codice
Bianco	h180 ↓ 265	<b>SPA3102</b>
Silver	h180 ↓ 265	<b>SPA3102</b>
Cromo	h240	<b>SPA31240ST-K</b>

### MISURE DI INGOMBRO PROFILI DI FISSAGGIO

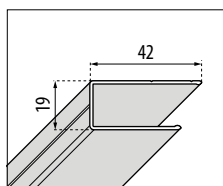

**A MURO**  
A - R - F - AH - PH - FH

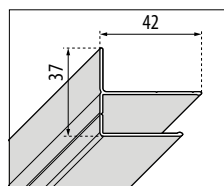

**A MURO**  
2P - G - B - S2 - 3P - 2A

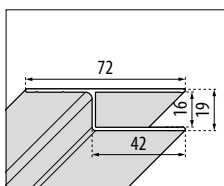

**A MURO**  
fissaggio a muro laterale  
tutti i modelli

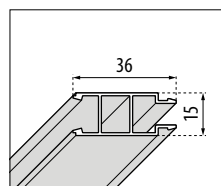

**COMPENSATIVI**  
tutti i modelli

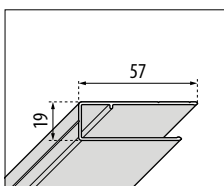

**COMPENSATIVI**  
A - R - F - AH - PH - FH

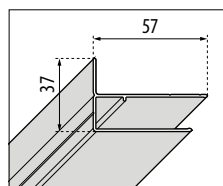

**COMPENSATIVI**  
2P - G - B - S2 - 3P - 2A

Finitura	Codice
Bianco	<b>P01BHRAST2-U</b>
Silver	<b>P01BHRAST2-B</b>
Cromo	<b>P01BHRAST2-K</b>
Nero	<b>P01BHRAST2-H</b>

Finitura	Codice
Bianco	<b>P01BHMOST2-U</b>
Silver	<b>P01BHMOST2-B</b>
Cromo	<b>P01BHMOST2-K</b>
Nero	<b>P01BHMOST2-H</b>

Finitura	Codice
Bianco	<b>P01L215STL2-U</b>
Silver	<b>P01L215STL2-B</b>
Cromo	<b>P01L215STL2-K</b>
Nero	<b>P01L215STL2-H</b>

Finitura	Codice
Bianco	<b>P05HAAST2-U</b>
Silver	<b>P05HAAST2-B</b>
Cromo	<b>P05HAAST2-K</b>
Nero	<b>P05HAAST2-H</b>

Finitura	Codice
Bianco	<b>P05BHST2-U</b>
Silver	<b>P05BHST2-B</b>
Cromo	<b>P05BHST2-K</b>
Nero	<b>P05BHST2-H</b>

Finitura	Codice
Bianco	<b>P05BHCST2-U</b>
Silver	<b>P05BHCST2-B</b>
Cromo	<b>P05BHCST2-K</b>
Nero	<b>P05BHCST2-H</b>

### COME RILEVARE LE MISURE

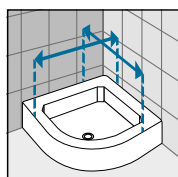
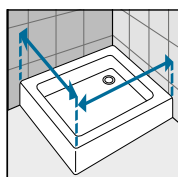

Rilevare le misure da muro a bordo esterno del piatto doccia. Le misure devono essere rilevate sulla parete finita, a rivestimenti posati, secondo gli schemi riportati.

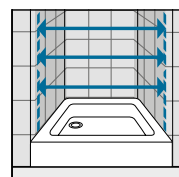

Rilevare le misure da muro a muro, in basso, in alto, al centro e utilizzare quella di valore inferiore. Le misure devono essere rilevate sulla parete finita, a rivestimenti posati, secondo gli schemi riportati.



# Piatti doccia



L'opzione giusta  
servita su un piatto doccia.



## Sagomabile

Piatto doccia sagomabile su misura per adattarlo facilmente a tutte le esigenze architettoniche.



## Texture effetto pietra

La preziosa texture con effetto naturale della pietra crea una sensazione tattile unica.



# NOVOMATT

## PIATTO DOCCIA IN MINERALSOLID EFFETTO PIETRA



8 cm

### OPTIONAL

Piletta di scarico ø 90  
non fornita

Codice

PIL90PCAB-CR40



### IN DOTAZIONE

Copripiletta in acciaio inox  
inclusa nel prezzo



### IL MATERIALE

NOVOMATT è un materiale composito tecnologicamente avanzato ed unico, formato da un'alta percentuale di cariche minerali naturali ed una bassa percentuale di polimeri poliesteri ed acrilici di elevata purezza; è quindi un materiale inerte, ipoallergenico e non tossico. È rivestito da uno smalto tecnico ad affetto estetico opaco. Questo rivestimento abbina ottime caratteristiche di resistenza a completa ripristinabilità della superficie.

Pietra  
bianco opaco  
(V3)

Pietra  
Grigio  
(V4)

Pietra  
Cappuccino  
(V5)

Pietra  
Tortora  
(V6)

Pietra Nero  
antracite  
(V7)

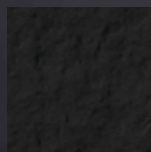
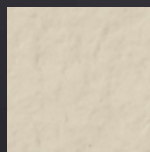
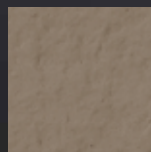
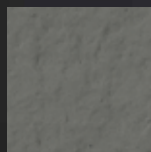
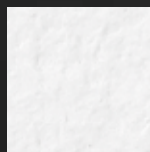

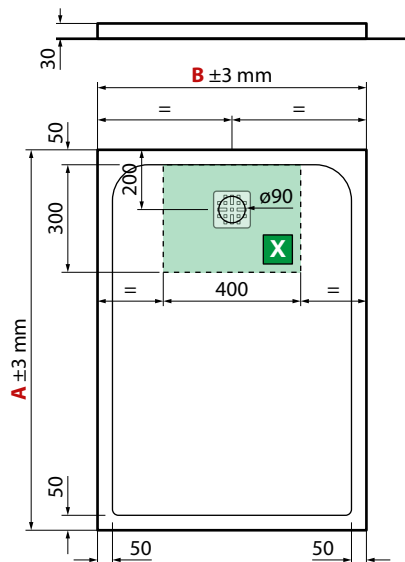

Solo per misure 180x80 e 180x90

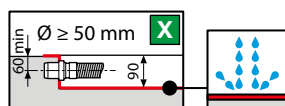
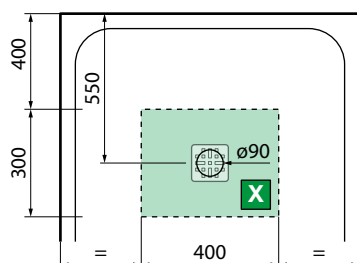

Misure		Codice	Scelta finitura / Prezzo				
			V3	V4	V5	V6	V7
			Pietra bianco opaco	Pietra grigio	Pietra cappuccino	Pietra tortora	Pietra nero antracite
<b>AxB ± 2 mm</b>							
80 x 80	800 x 800	<b>NVM803-</b>					
90 x 90	900 x 900	<b>NVM903-</b>					
100 x 100	1000 x 1000	<b>NVM1003-</b>					
90 x 70	900 x 700	<b>NVM90703-</b>					
100 x 70	1000 x 700	<b>NVM100703-</b>					
100 x 80	1000 x 800	<b>NVM100803-</b>					
100 x 90	1000 x 900	<b>NVM100903-</b>					
120 x 70	1200 x 700	<b>NVM120703-</b>					
120 x 80	1200 x 800	<b>NVM120803-</b>					
120 x 90	1200 x 900	<b>NVM120903-</b>					
120 x 100	1200 x 1000	<b>NVM120103-</b>					
140 x 70	1400 x 700	<b>NVM140703-</b>					
140 x 80	1400 x 800	<b>NVM140803-</b>					
140 x 90	1400 x 900	<b>NVM140903-</b>					
140 x 100	1400 x 1000	<b>NVM140103-</b>					
160 x 70	1600 x 700	<b>NVM160703-</b>					
160 x 80	1600 x 800	<b>NVM160803-</b>					
160 x 90	1600 x 900	<b>NVM160903-</b>					
160 x 100	1600 x 1000	<b>NVM160103-</b>					
180 x 80	1800 x 800	<b>NVM180803-</b>					
180 x 90	1800 x 900	<b>NVM180903-</b>					

Costruzione del codice **Codice + Finitura** = Codice prodotto finale

## SAGOMATURA SU MISURA

I piatti NOVOMATT possono essere tagliati dall'installatore fino a 2,5cm dal bordo, Novellini offre un servizio di taglio in lunghezza e/o larghezza **comunicando le misure al momento dell'ordine**. Forniamo anche i piatti doccia con scassi eseguiti su misura per sagomare il piatto doccia esattamente allo spazio disponibile. I tagli devono comunque essere rettilinei, non sono quindi consentiti tagli curvi o ad arco (**taglio fuori squadra fino a 2,5 cm\***). Non è poi possibile tagliare il piatto doccia attorno allo scarico per un'area pari a 40 x 40 cm.



Riduzione lato corto

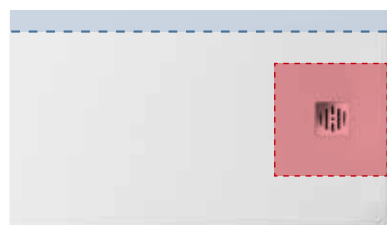

Riduzione lato lungo

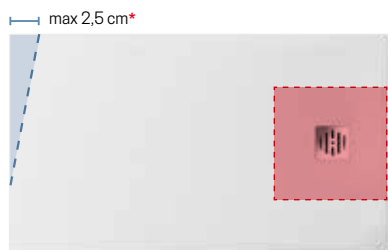

Riduzione lato corto taglio obliquo fuori squadra \*



Taglio speciale giro colonna

**TAGLIO** (consegna indicativa 4-5 settimane)  
**AREA NON TAGLIABILE**

### 1 Taglio

riduzione in larghezza / in profondità  
**taglio fuori squadra fino a 2,5 cm**  
 senza ripristino della texture

### 2 Taglio

riduzione in larghezza / in profondità  
**taglio fuori squadra fino a 2,5 cm**  
 con ripristino della texture

### 3 Taglio

riduzione in larghezza / in profondità  
**taglio fuori squadra oltre 2,5 cm**  
 senza ripristino della texture

### 4 Taglio

riduzione in larghezza / in profondità  
**taglio fuori squadra oltre 2,5 cm**  
 con ripristino della texture

### 5 Taglio

speciale giro colonna  
 prezzo indicativo per solo taglio grezzo - eventuali ricostruzioni da valutare e quotare di volta in volta.



# OLYMPIC PLUS

PIATTO DOCCIA RINFORZATO  
CON PROFILI IN ACCIAIO



## IN DOTAZIONE

Piletta di scarico ø 90  
inclusa nel prezzo

8 cm

fondo liscio

**SCONTO 10%** **ORDINANDO 10 PEZZI**  
**PROMO 2022**

Bianco  
(30)

Bianco morbido  
(79)

Beige  
(11)

Corda  
(27)

Grigio  
(29)

Nero  
(28)

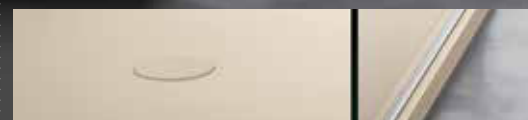
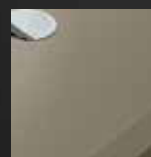
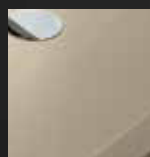

## OPTIONAL

Copripiletta colore del piatto

Finitura	Codice
Bianco	<b>KR90CPILOLP-30</b>
Bianco morbido	<b>KR90CPILOLP-79</b>
Beige	<b>KR90CPILOLP-11</b>
Corda	<b>KR90CPILOLP-27</b>
Nero	<b>KR90CPILOLP-28</b>
Grigio	<b>KR90CPILOLP-29</b>



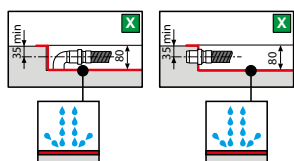
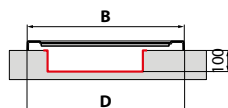
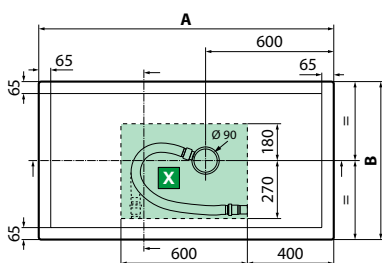
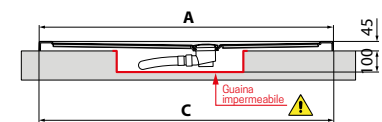

**X** Zona incassata a pavimento per lo scarico H 100 mm



\* Profilo di rinforzo in acciaio

# OLYMPIC PLUS

SPESORE 4,5 CM

Misure			Codice	Scelta finitura / Prezzo						
	AxB*	CxD**		30	30	79	11	27	29	28
	± 2 mm	± 3 mm		Bianco	Bianco 10 PZ	Bianco morbido	Beige	Corda	Grigio	Nero
110 x 70	1094 x 692	1096 x 694	OL110704-							
110 x 80	1094 x 792	1096 x 794	OL110804-							
120 x 70	1194 x 692	1196 x 694	OL120704-							
120 x 80	1194 x 792	1196 x 794	OL801204-							
120 x 90	1194 x 892	1196 x 894	OL120904-							
120 x 100	1194 x 992	1196 x 994	OL120104-							
140 x 70	1392 x 692	1394 x 694	OL140704-							
140 x 75	1392 x 742	1394 x 744	OL140754-							
140 x 80	1392 x 792	1394 x 794	OL140804-							
140 x 90	1392 x 892	1394 x 894	OL140904-							
140 x 100	1392 x 992	1394 x 994	OL140104-							
150 x 70	1492 x 692	1494 x 694	OL150704-							
150 x 75	1492 x 742	1494 x 744	OL150754-							
160 x 70	1592 x 692	1594 x 694	OL160704-							
160 x 75	1592 x 742	1594 x 744	OL160754-							
160 x 80	1592 x 792	1594 x 794	OL160804-							
160 x 90	1592 x 892	1594 x 894	OL160904-							
170 x 70	1692 x 692	1694 x 694	OL170704-							
170 x 75	1692 x 742	1694 x 744	OL170754-							
170 x 80	1692 x 792	1694 x 794	OL170804-							
170 x 90	1692 x 892	1694 x 894	OL170904-							
180 x 75	1792 x 742	1794 x 744	OL180754-							
180 x 80	1792 x 792	1794 x 794	OL180804-							
180 x 90	1792 x 892	1794 x 894	OL180904-							

OLYMPIC PLUS

# OLYMPIC PLUS

SPESORE 12,5 CM

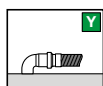
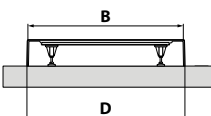
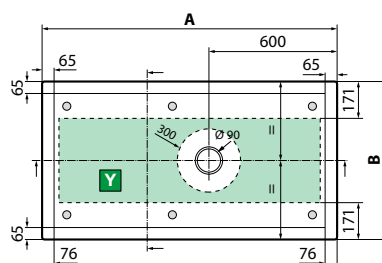
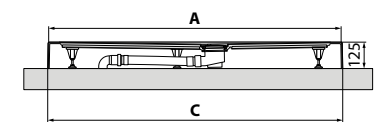

**Y** Zona disponibile per lo scarico sopra pavimento

Misure			Codice	Scelta finitura / Prezzo						
	AxB*	CxD**		30	30	79	11	27	29	28
	± 2 mm	± 3 mm		Bianco	Bianco 10 PZ	Bianco morbido	Beige	Corda	Grigio	Nero
110 x 70	1094 x 692	1100 x 698	OL1107011-							
110 x 80	1094 x 792	1100 x 798	OL1108011-							
120 x 70	1194 x 692	1200 x 698	OL1207011-							
120 x 80	1194 x 792	1200 x 798	OL8012011-							
120 x 90	1194 x 892	1200 x 898	OL1209011-							
120 x 100	1194 x 992	1200 x 998	OL1201011-							
140 x 70	1392 x 692	1398 x 698	OL1407011-							
140 x 75	1392 x 742	1398 x 748	OL1407511-							
140 x 80	1392 x 792	1398 x 798	OL1408011-							
140 x 90	1392 x 892	1398 x 898	OL1409011-							
140 x 100	1392 x 992	1398 x 998	OL1401011-							
150 x 70	1492 x 692	1498 x 698	OL1507011-							
150 x 75	1492 x 742	1498 x 748	OL1507511-							
160 x 70	1592 x 692	1598 x 698	OL1607011-							
160 x 75	1592 x 742	1598 x 748	OL1607511-							
160 x 80	1592 x 792	1598 x 798	OL1608011-							
160 x 90	1592 x 892	1598 x 898	OL1609011-							
170 x 70	1692 x 692	1698 x 698	OL1707011-							
170 x 75	1692 x 742	1698 x 748	OL1707511-							
170 x 80	1692 x 792	1698 x 798	OL1708011-							
170 x 90	1692 x 892	1698 x 898	OL1709011-							
180 x 75	1792 x 742	1798 x 748	OL1807511-							
180 x 80	1792 x 792	1798 x 798	OL1808011-							
180 x 90	1792 x 892	1798 x 898	OL1809011-							

**BIANCO 10 PZ.: PREZZO PER ORDINE UNICO DI 10 PZ. DI QUALSIASI MISURA PER ENTRAMBE LE ALTEZZE (SOLO BIANCO LUCIDO)**

Costruzione del codice **Codice + Finitura** = Codice prodotto finale

\* Misure della parte superiore del piatto  
\*\* Misure del piatto a pavimento





# OLYMPIC

## PIATTO DOCCIA QUADRATO O RETTANGOLARE



fondo liscio



### OPTIONAL

Piletta di scarico  $\varnothing$  90  
non fornita

Codice
<b>PIL90PCAB-CR40</b>

Per una ottimale tenuta si consiglia l'uso della nostra piletta di scarico **PIL90PCAB-CR40**, oppure di pilette di scarico dotate di guarnizione a doppio labbro

**SCONTO 10%** ORDINANDO 10 PEZZI  
**PROMO 2022**

Bianco  
(30)

Bianco morbido  
(79)

Beige  
(11)

Corda  
(27)

Grigio  
(29)

Nero  
(28)

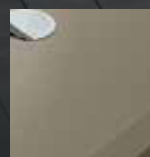
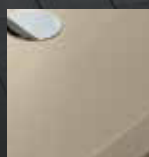

### OPTIONAL

Copripiletta colore del piatto

Finitura	Codice
Bianco	<b>KR90CPILOLP-30</b>
Bianco morbido	<b>KR90CPILOLP-79</b>
Beige	<b>KR90CPILOLP-11</b>
Corda	<b>KR90CPILOLP-27</b>
Nero	<b>KR90CPILOLP-28</b>
Grigio	<b>KR90CPILOLP-29</b>





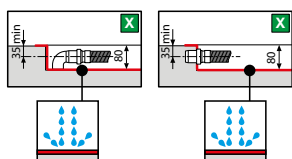
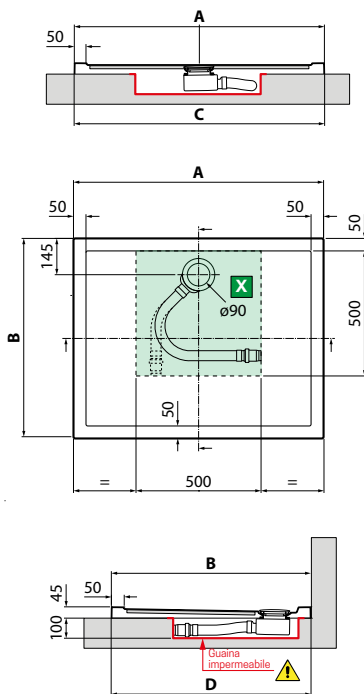

# OLYMPIC

SPESORE 4,5 CM

Misure			Codice	Scelta finitura / Prezzo						
	AxB *	CxD **		30	30	79	11	27	29	28
	± 2 mm	± 3 mm		Bianco	Bianco 10 PZ	Bianco morbido	Beige	Corda	Grigio	Nero
80 x 80	794 x 794	796 x 796	<b>OLN804-</b>							
90 x 90	894 x 894	896 x 896	<b>OLN904-</b>							
100 x 100	994 x 994	996 x 996	<b>OLN1004-</b>							
90 x 70	894 x 694	896 x 696	<b>OLN90704-</b>							
90 x 75	894 x 744	896 x 746	<b>OLN90754-</b>							
100 x 70	994 x 694	996 x 696	<b>OLN100704-</b>							
100 x 80	994 x 794	996 x 796	<b>OLN100804-</b>							
120 x 80	1194 x 794	1196 x 796	<b>OLN120804-</b>							
120 x 90	1194 x 894	1196 x 896	<b>OLN120904-</b>							

- \* Misure della parte superiore del piatto
- \*\* Misure del piatto a pavimento

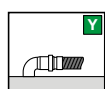
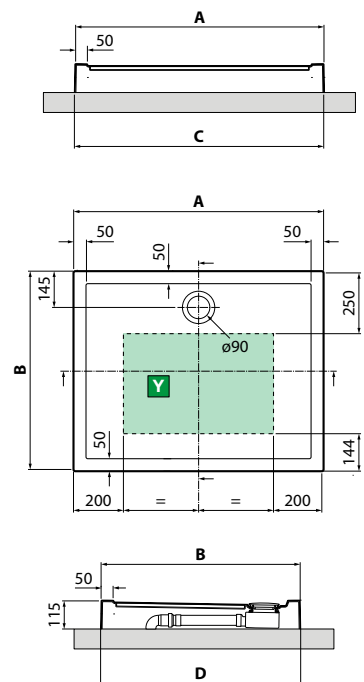

# OLYMPIC

SPESORE 11,5 CM

Misure			Codice	Scelta finitura / Prezzo						
	AxB *	CxD **		30	30	79	11	27	29	28
	± 2 mm	± 3 mm		Bianco	Bianco 10 PZ	Bianco morbido	Beige	Corda	Grigio	Nero
80 x 80	794 x 794	798 x 798	<b>OLN8011-</b>							
90 x 90	894 x 894	898 x 898	<b>OLN9011-</b>							
100 x 100	994 x 994	998 x 998	<b>OLN10011-</b>							
90 x 70	894 x 694	898 x 698	<b>OLN907011-</b>							
90 x 75	894 x 744	898 x 748	<b>OLN907511-</b>							
100 x 70	994 x 694	998 x 698	<b>OLN1007011-</b>							
100 x 80	994 x 794	998 x 798	<b>OLN1008011-</b>							
120 x 80	1194 x 794	1198 x 798	<b>OLN1208011-</b>							
120 x 90	1194 x 894	1198 x 898	<b>OLN1209011-</b>							

- \* Misure della parte superiore del piatto
- \*\* Misure del piatto a pavimento

**BIANCO 10 PZ.: PREZZO PER ORDINE UNICO DI 10 PZ. DI QUALSIASI MISURA PER ENTRAMBE LE ALTEZZE (SOLO BIANCO LUCIDO)**



# Colonne doccia



Il complemento giusto  
alla tua doccia - significa benessere.



## Portaoggetti orizzontale

Design e funzionalità si fondono nella colonna Novellini, espressione di stile e di funzione grazie a un pratico ripiano d'appoggio in cui il miscelatore è elegantemente racchiuso.



## Idromassaggio verticale

Un ricercato minimalismo plasma la forma della colonna Z, integrata con un idromassaggio verticale che dona un senso di precisa linearità.

# F

## COLONNA ATTREZZATA CON SOFFIONE, INSTALLABILE A PARETE

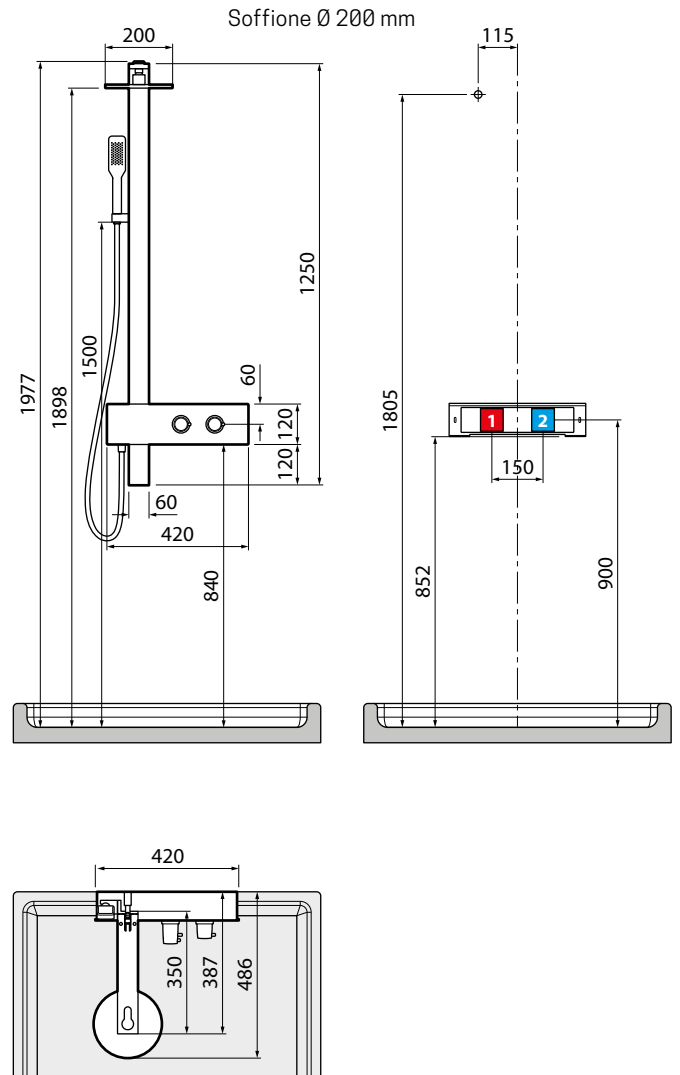

Miscelatore	Misure (cm)	Codice	Finitura		
			<b>U</b>	<b>H</b>	<b>B</b>
			Bianco opaco	Nero opaco	Silver

STANDARD					
Meccanico	42x8,4x125	<b>EFFEM-</b>			
Termostatico	42x8,4x125	<b>EFFET-</b>			

**1 2** Allacci per rubinetteria

- 1** CARATTERISTICHE IDRAULICHE  
Pressione dinamica ottimale 2÷5 bar  
Acqua calda 1/2"
- 2** Acqua fredda 1/2"



# Z

## COLONNA ATTREZZATA, INSTALLABILE AD ANGOLO E A PARETE

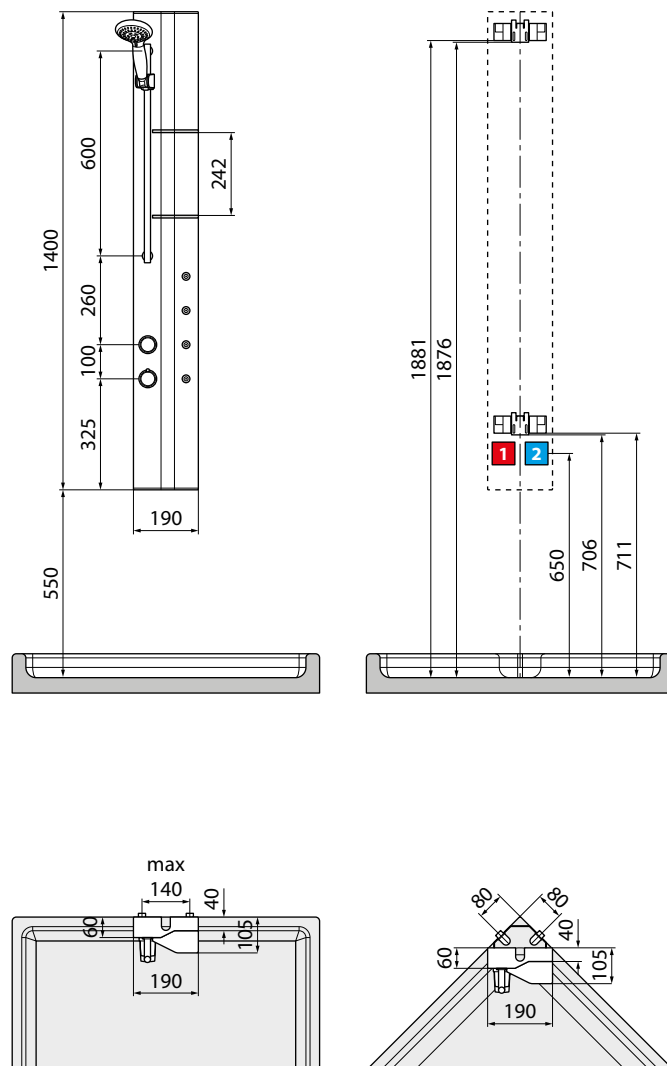

COLONNE DOCCIA

Miscelatore	Misure (cm)	Codice	Finitura		
			<b>U</b> Bianco opaco	<b>H</b> Nero opaco	<b>B</b> Silver

### STANDARD

Meccanico	19x6x140	<b>ZETAM-</b>			
Termostatico	19x6x140	<b>ZETAT-</b>			

### IDROMASSAGGIO

Meccanico	19x6x140	<b>ZETAVM-</b>			
Termostatico	19x6x140	<b>ZETAVT-</b>			

1 2 Allacci per rubinetteria

- 1** **CARATTERISTICHE IDRAULICHE**  
Pressione dinamica ottimale 2÷5 bar  
Acqua calda 1/2"
- 2** **CARATTERISTICHE IDRAULICHE**  
Acqua fredda 1/2"

Costruzione del codice **Codice** + **Finitura** = Codice prodotto finale





# Cabine doccia



La più incredibile esperienza doccia è custodita nelle cabine Novellini.



## Porta oggetti

Comodo ripiano di appoggio arricchisce la cabina di dettagli funzionali.



## Asta sali-scendi da interno cabina

Elemento duttile e pratico pensato per regalare un confort da ogni punto di vista.



MEDIA GLASS 2P



MEDIA GLASS GF

## MEDIA GLASS | FINITURE

### FINITURE STRUTTURA



Bianco lucido

### FINITURA VETRI



Trasparente

## MEDIA GLASS | FUNZIONI E DOTAZIONI (disponibili a seconda dell'allestimento)



Miscelatore meccanico o termostatico e doccia a mano con flessibile orientabile

Tettuccio con soffione doccia

Ripiani d'appoggio



MEDIA GLASS A

MEDIA GLASS



Facilità di installazione  
direttamente in angolo



Pareti di fondo  
in vetro temprato da 4 mm



Ripiano d'appoggio



Saliscendi con snodo frontale

# MEDIA GLASS



# MEDIA GLASS 2P



**CABINA MULTIFUNZIONE ASIMMETRICA,  
APERTURA 1 ANTA SCORREVOLE E 1 FISSA IN LINEA CON 1 FISSO LATERALE**

Misure			Codice	Miscelatore		Vetro	Scelta finitura
Dimensioni (cm)	Altezza totale (cm)	Entrata (cm)		M	T	1	Finitura bianco lucido
	<b>C</b>	*		Meccanico	Termostatico	Trasparente	Bianco

STANDARD							
Dimensioni (cm)	Altezza totale (cm)	Entrata (cm)	Codice	M	T	Vetro	Finitura
120 X 80	210	47	<b>MEG2P120</b>	M-	T-	1	AA

STANDARD CON TETTuccio E SOFFIONE							
Dimensioni (cm)	Altezza totale (cm)	Entrata (cm)	Codice	M	T	Vetro	Finitura
120 X 80	226	47	<b>MEG2P120</b>	MF-	TF-	1	AA





MEDIA GLASS

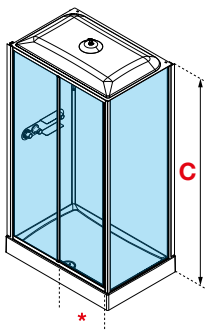

Installazione a sinistra

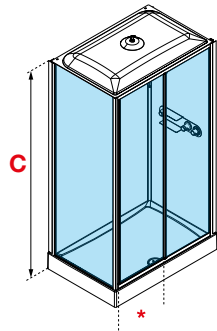

Installazione a destra

# MEDIA GLASS GF



207 cm 3 mm Porta 4 mm pareti

**CABINA MULTIFUNZIONE, APERTURA 1 ANTA BATTENTE CON FISSO LATERALE**



Misure			Codice	Miscelatore		Vetro	Scelta finitura
Dimensioni (cm)	Altezza totale (cm)	Entrata (cm)		M	T		Finitura bianco lucido
	<b>C</b>	*		Meccanico	Termostatico	1	AA
						Trasparente	Bianco

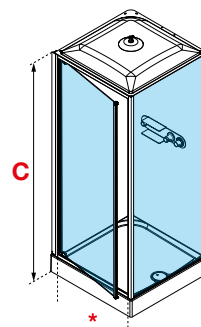

Installazione a sinistra

STANDARD								
Dimensioni (cm)	Altezza totale (cm)	Entrata (cm)	Codice	Miscelatore	Vetro	Finitura	Icone	
80 X 80	210	60	<b>MEGGF80</b>	M-	T-	1	AA	
90 X 90	210	70	<b>MEGGF90</b>					

STANDARD CON TETTuccio E SOFFIONE								
Dimensioni (cm)	Altezza totale (cm)	Entrata (cm)	Codice	Miscelatore	Vetro	Finitura	Icone	
80 X 80	226	60	<b>MEGGF80</b>	MF-	TF-	1	AA	
90 X 90	226	70	<b>MEGGF90</b>					

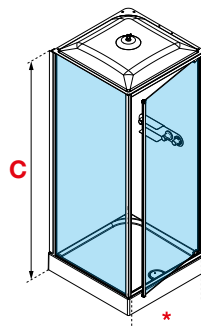

Installazione a destra



# MEDIA GLASS A



207 cm 3 mm Porta 4 mm pareti

CABINA MULTIFUNZIONE, APERTURA 2 ANTE SCORREVOLI E 2 FISSE



Misure			Codice	Miscelatore		Vetro	Scelta finitura	
Dimensioni (cm)	Altezza totale (cm)	Entrata (cm)		M	T		Finitura bianco lucido	
	<b>C</b>	*		M	T	1	AA	
				Meccanico	Termostatico	Trasparente	Bianco	

STANDARD							
				M-	T-	1	AA
80 X 80	210	44	<b>MEGA80</b>				
90 X 90	210	48	<b>MEGA90</b>				
90 X 70	210	36	<b>MEGA7090</b>				
100 X 70	210	48	<b>MEGA107</b>				
100 X 80	210	50	<b>MEGA100</b>				

STANDARD CON TETTuccio E SOFFIONE							
				MF-	TF-	1	AA
80 X 80	226	44	<b>MEGA80</b>				
90 X 90	226	48	<b>MEGA90</b>				
90 X 70	226	36	<b>MEGA7090</b>				
100 X 70	226	48	<b>MEGA107</b>				
100 X 80	226	50	<b>MEGA100</b>				

80x80 - 90x90

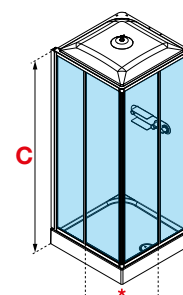

90x70 - 100x70 - 100x80

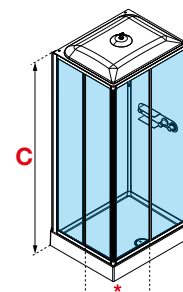

Installazione a destra

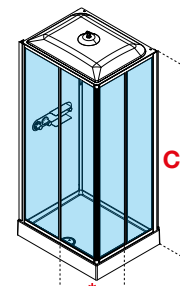

Installazione a sinistra

Costruzione del codice **Codice** + **Miscelatore** + **Vetro** + **Finitura** = Codice prodotto finale

# MEDIA GLASS R



207 cm 3 mm Porta 4 mm pareti

**CABINA MULTIFUNZIONE SEMICIRCOLARE, APERTURA 2 ANTE SCORREVOLI E 2 FISSE**



Misure			Codice	Miscelatore		Vetro	Scelta finitura
Dimensioni (cm)	Altezza totale (cm)	Entrata (cm)		M	T		Finitura bianco lucido
	<b>C</b>	*		M	T	1	AA
				Meccanico	Termostatico	Trasparente	Bianco

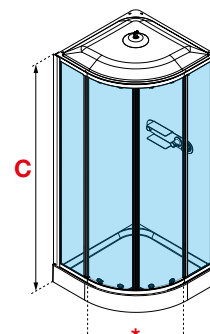

STANDARD							
				M-	T-	1	AA
90 X 90	210	48	<b>MEGR90</b>				

STANDARD CON TETTuccio E SOFFIONE							
				MF-	TF-	1	AA
90 X 90	226	48	<b>MEGR90</b>				



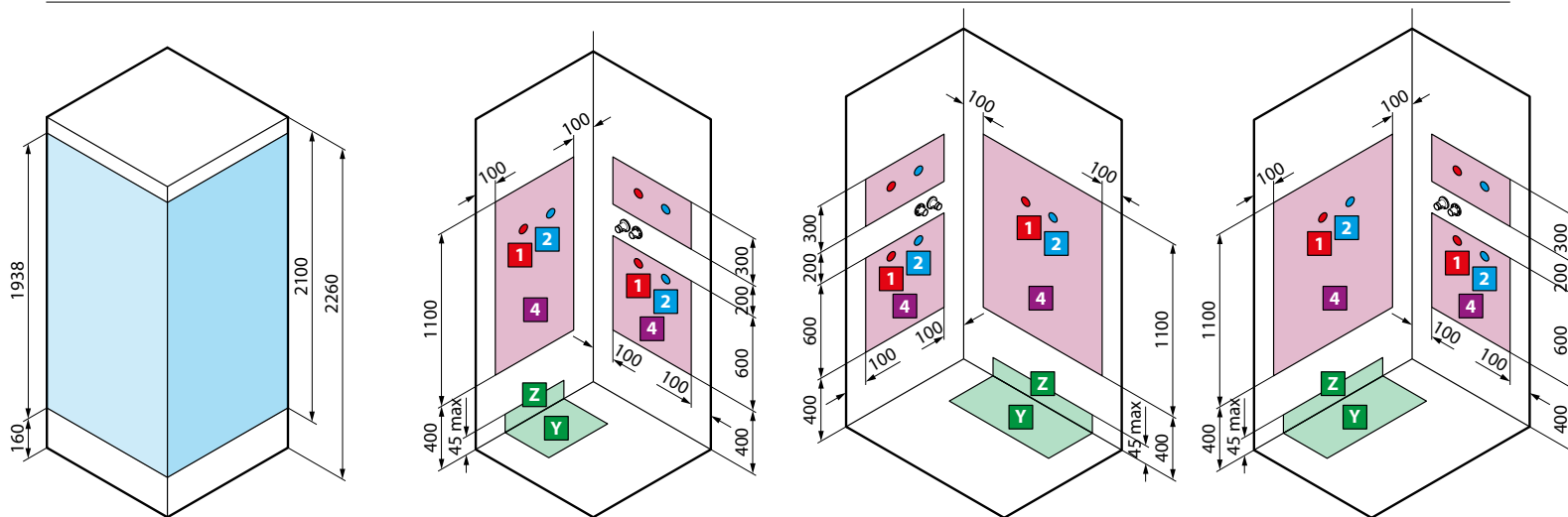

per modelli  
**A80 - A90 - R90 - GF80 - GF90**

versione **sinistra** | versione **destra**  
per modelli **A 90x70 - A 100x70 - A 100x80 - 2P 120x80**

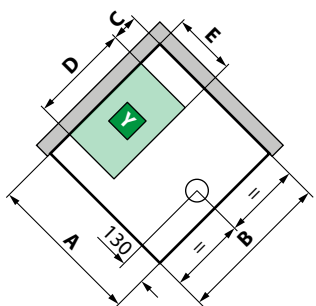

modello	A ± 5	B ± 5	C	D	E
<b>A80</b>	804	804	200	404	300
<b>A90</b>	904	904	200	504	300
<b>GF80</b>	804	804	200	404	300
<b>GF90</b>	904	904	200	504	300

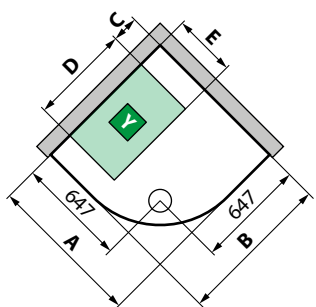

modello	A ± 5	B ± 5	C	D	E
<b>R90</b>	904	904	200	504	300

**S** INSTALLAZIONE A SINISTRA

**D** INSTALLAZIONE A DESTRA

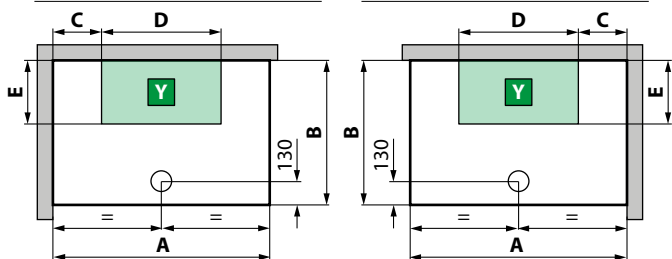

modello	A ± 5	B ± 5	C	D	E
<b>A90x70</b>	904	704	200	504	300
<b>A100x70</b>	1004	704	200	604	300
<b>A100x80</b>	1004	804	200	604	300
<b>2P120x80</b>	1204	804	200	804	300

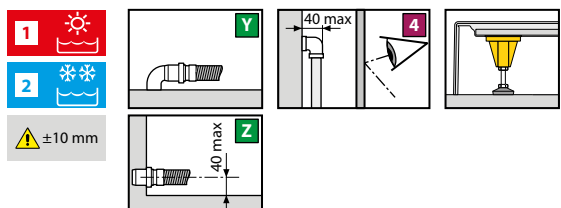

**CARATTERISTICHE IDRAULICHE:**

Pressione dinamica ottimale 2÷5 bar  
Acqua calda 1/2"  
Acqua fredda 1/2"  
Allaccio sifone con raccordo ø 40 mm



# Vasche



Il miglior tempo  
da regalare a se stessi.



MDi, materiale innovativo per donare esclusività,  
eleganza ed emozione al tuo bagno

Materiale sinterizzato di polveri naturali al 50% riciclate, in cui vengono impiegati smalti ed inchiostri a base d'acqua.  
La tecnologia esclusiva H2O Full Digital rende il prodotto omogeneo nella colorazione in tutto il suo spessore.  
MDi: 100% riciclabile

# L'idromassaggio che coniuga estetica e funzione.

La nuova sensazione di benessere che prende forma grazie a dettagli innovativi.  
Un modo di vivere l'idromassaggio totalmente personalizzabile in termini di prestazioni, design e sensorialità.  
Lasciati andare ad un benessere unico firmato Novellini.



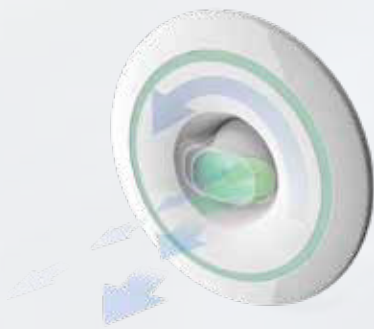

Bocchetta a filo  
Direzione del flusso regolabile  
Intensità del flusso regolabile  
**Cromolight integrato**  
Massaggio energetico



**STILE**  
Bocchetta in tinta  
con la vasca



**SENSE 2.0**  
Bocchetta con  
ghiera cromata





VASCA BIANCO MORBIDO CON PANNELLI IN DOLOMITE



VASCA BIANCO MORBIDO CON PANNELLI IN ARGILLA POLVERE E FRAME NERO OPACO

## STILE | FINITURE PANNELLI

### ACRILICO



Bianco lucido Bianco morbido

### LEGNO



Bianco rigato Grain Burlington Dolomite

### ARGILLA

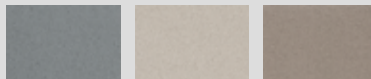

Cenere Polvere Tortora

### MDI



Umbra Sabbia

### FRAME ALLUMINIO NERO OPACO

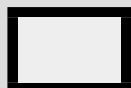

Bianco morbido

### LEGNO

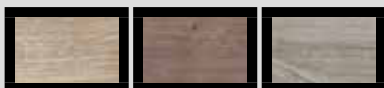

Grain Burlington Dolomite

### ARGILLA

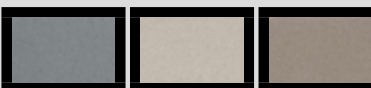

Cenere Polvere Tortora

### MDI



Umbra Sabbia

### FRAME ALLUMINIO BIANCO OPACO

### LEGNO

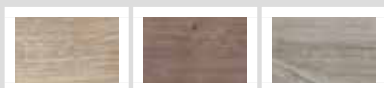

Grain Burlington Dolomite

### ARGILLA

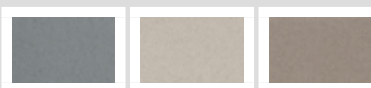

Cenere Polvere Tortora

### MDI

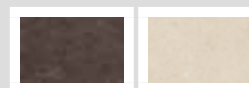

Umbra Sabbia

## STILE | FUNZIONI E DOTAZIONI (disponibili a seconda dell'allestimento)

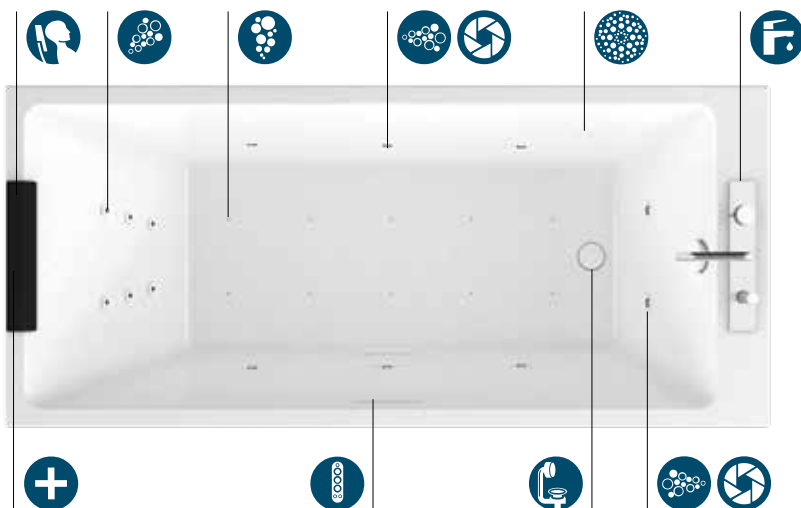

- Massaggio Airpool (10/16 jets)** a getto d'aria con accensione manuale on/off. Per una **efficace stimolazione cellulare**.
- Massaggio corpo Whirlpool (6/8 jets)** aria/acqua con regolazione di tempo e intensità manuale o automatica. Per soddisfare qualsiasi esigenza di benessere. **Cromolight** con 8 variazioni cromatiche per attivare la mente ed emozionare lo spirito.
- Massaggio Whirlpool dorsale (6 jets)** aria/acqua.
- Natural air**
- Pannello di controllo** con funzioni Hydro sequence
- Poggiatesta** in materiale antibatterico.
- Rubinetteria bordo vasca**
- Colonna di scarico**
- Disinfezione**

Designed by Marco Pellici



VASCA BIANCO MORBIDO CON PANNELLI IN ARGILLA CENERE E FRAME NERO OPACO



Pannello di comando capacitivo



Piano di appoggio



Nuova manopola di scarico ultra-flat



Nuove bocchette idromassaggio

STILE

STILE

# STILE

## VASCA RETTANGOLARE

Misure			Capacità	Codice	Scelta rubinetteria + finitura vasca						Scelta struttura/pannelli	
Cm	H	Lt.			Colonna di scarico senza rubinetteria		Colonna di scarico con erogazione da troppo pieno		Colonna di scarico + rubinetteria bordo vasca		Solo struttura	Con pannelli
					Bianco lucido	Bianco morbido	Bianco lucido	Bianco morbido	Bianco lucido	Bianco morbido		

STANDARD DA INCASSO				0-A	0-U	1-A	1-U	2-A	2-U	0K	
170 x 70	63	250	<b>STI117970</b>								
170 x 75	63	280	<b>STI117975</b>								
180 x 80	63	330	<b>STI118980</b>								

STANDARD CON TELAIO				0-A	0-U	1-A	1-U	2-A	2-U	0K	*
170 x 70	63	250	<b>STI217970</b>								* Vedi tabella <b>SCELTA FINITURA PANNELLO</b>
170 x 75	63	280	<b>STI217975</b>								
180 x 80	63	330	<b>STI218980</b>								

HYDRO AIR				0-A	0-U	1-A	1-U	2-A	2-U	0K	*
170 x 70	63	250	<b>STIY179700</b>								* Vedi tabella <b>SCELTA FINITURA PANNELLO</b>
170 x 75	63	280	<b>STIY179750</b>								
180 x 80	63	330	<b>STIY189800</b>								

WHIRLPOOL				0-A	0-U	1-A	1-U	2-A	2-U	0K	*
170 x 70	63	250	<b>STI5179700</b>								* Vedi tabella <b>SCELTA FINITURA PANNELLO</b>
170 x 75	63	280	<b>STI5179750</b>								
180 x 80	63	330	<b>STI5189800</b>								

WHIRLPOOL+DISINFEZIONE+LIGHT				0-A	0-U	1-A	1-U	2-A	2-U	0K	*
170 x 70	63	250	<b>STI3179700</b>								* Vedi tabella <b>SCELTA FINITURA PANNELLO</b>
170 x 75	63	280	<b>STI3179750</b>								
180 x 80	63	330	<b>STI3189800</b>								

HYDRO PLUS				0-A	0-U	1-A	1-U	2-A	2-U	0K	*
170 x 70	63	250	<b>STI4179700</b>								* Vedi tabella <b>SCELTA FINITURA PANNELLO</b>
170 x 75	63	280	<b>STI4179750</b>								
180 x 80	63	330	<b>STI4189800</b>								

NATURAL AIR + WHIRLPOOL				0-A	0-U	1-A	1-U	2-A	2-U	0K	*
170 x 70	63	250	<b>STIP179700</b>								* Vedi tabella <b>SCELTA FINITURA PANNELLO</b>
170 x 75	63	280	<b>STIP179750</b>								
180 x 80	63	330	<b>STIP189800</b>								





VERSIONE AD ANGOLO

Scelta numero pannelli				Scelta finitura pannelli / prezzo					
				ACRILICO		LEGNI			
1 frontale	1 frontale + 1 laterale	1 frontale + 2 laterali	2 frontali + 2 laterali	Bianco Lucido	Bianco morbido	Bianco rigato	Grain	Burlington	Dolomite
<b>1</b>	<b>2</b>	<b>3</b>	<b>4</b>	<b>A</b>	<b>U</b>	<b>I</b>	<b>M</b>	<b>N</b>	<b>X</b>
	-	-	-						
-		-	-						
-	-		-						
-	-	-							

Costruzione codice vasca senza pannelli **Codice** + **Scelta scarico/erogazione + Finitura vasca** + **Scelta struttura senza pannelli** = Codice prodotto finale

Costruzione codice vasca con pannelli **Codice** + **Scelta scarico/erogazione + Finitura vasca** + **Scelta struttura con pannelli (acrilico o legni)** = Codice prodotto finale





**RUBINETTERIA IN COLORE NERO SU RICHIESTA**

STILE



**PER LA VERSIONE CON I PANNELLI IN FINITURA ARGILLA/FRAME ORDINARE: 1 CODICE VASCA SOLO STRUTTURA + 1 CODICE PANNELLI ARGILLA/FRAME (QUI SOTTO)**

Misure	CODICE Scelta numero pannelli	Scelta finitura pannelli				
		ARGILLA		MDI		
	1 frontale	Cenere	Polvere	Tortora	Umbra	Sabbia
		<b>R</b>	<b>O</b>	<b>S</b>	<b>1</b>	<b>2</b>
170 x 70; 170 x 75	<b>PANV1FDI179-</b>					
180 x 80	<b>PANV1FDI189-</b>					

Misure	CODICE Scelta numero pannelli	Scelta finitura pannelli				
		ARGILLA		MDI		
	1 frontale + 1 laterale	Cenere	Polvere	Tortora	Umbra	Sabbia
		<b>R</b>	<b>O</b>	<b>S</b>	<b>1</b>	<b>2</b>
170 x 70	<b>PANV1F1LDI17970-</b>					
170 x 75	<b>PANV1F1LDI17975-</b>					
180 x 80	<b>PANV1F1LDI18980-</b>					

Misure	CODICE Scelta numero pannelli	Scelta finitura pannelli				
		ARGILLA		MDI		
	1 frontale + 2 laterali	Cenere	Polvere	Tortora	Umbra	Sabbia
		<b>R</b>	<b>O</b>	<b>S</b>	<b>1</b>	<b>2</b>
170 x 70	<b>PANV1F2LDI17970-</b>					
170 x 75	<b>PANV1F2LDI17975-</b>					
180 x 80	<b>PANV1F2LDI18980-</b>					

Misure	CODICE Scelta numero pannelli	Scelta finitura pannelli				
		ARGILLA		MDI		
	2 frontali + 2 laterali	Cenere	Polvere	Tortora	Umbra	Sabbia
		<b>R</b>	<b>O</b>	<b>S</b>	<b>1</b>	<b>2</b>
170 x 70	<b>PANV2F2LDI17970-</b>					
170 x 75	<b>PANV2F2LDI17975-</b>					
180 x 80	<b>PANV2F2LDI18980-</b>					

Finitura FRAME	Scelta finitura pannelli per FRAME									
	FRAME		LEGNI			ARGILLA			MDI	
Bianco Opaco	Nero Opaco	Bianco Opaco*	Grain	Burlington	Dolomite	Cenere	Polvere	Tortora	Umbra	Sabbia
<b>U</b>	<b>H</b>	<b>U</b>	<b>M</b>	<b>N</b>	<b>X</b>	<b>R</b>	<b>O</b>	<b>S</b>	<b>1</b>	<b>2</b>

Finitura FRAME	Scelta finitura pannelli per FRAME									
	FRAME		LEGNI			ARGILLA			MDI	
Bianco Opaco	Nero Opaco	Bianco Opaco*	Grain	Burlington	Dolomite	Cenere	Polvere	Tortora	Umbra	Sabbia
<b>U</b>	<b>H</b>	<b>U</b>	<b>M</b>	<b>N</b>	<b>X</b>	<b>R</b>	<b>O</b>	<b>S</b>	<b>1</b>	<b>2</b>

Finitura FRAME	Scelta finitura pannelli per FRAME									
	FRAME		LEGNI			ARGILLA			MDI	
Bianco Opaco	Nero Opaco	Bianco Opaco*	Grain	Burlington	Dolomite	Cenere	Polvere	Tortora	Umbra	Sabbia
<b>U</b>	<b>H</b>	<b>U</b>	<b>M</b>	<b>N</b>	<b>X</b>	<b>R</b>	<b>O</b>	<b>S</b>	<b>1</b>	<b>2</b>

Finitura FRAME	Scelta finitura pannelli per FRAME									
	FRAME		LEGNI			ARGILLA			MDI	
Bianco Opaco	Nero Opaco	Bianco Opaco*	Grain	Burlington	Dolomite	Cenere	Polvere	Tortora	Umbra	Sabbia
<b>U</b>	<b>H</b>	<b>U</b>	<b>M</b>	<b>N</b>	<b>X</b>	<b>R</b>	<b>O</b>	<b>S</b>	<b>1</b>	<b>2</b>

**FRAME SOLO SU PANNELLI FRONTALI**

\* LA FINITURA DI PANNELLO BIANCO OPACO È DISPONIBILE SOLO CON FRAME NERO OPACO

Costruzione del codice **Codice** + **Finitura pannelli** = Codice prodotto finale

Costruzione del codice **Codice** + **Finitura Frame** + **Finitura pannelli** = Codice prodotto finale

**COLORI SPECIALI SU RICHIESTA PER PANNELLI ARGILLA E FRAME ARGILLA**

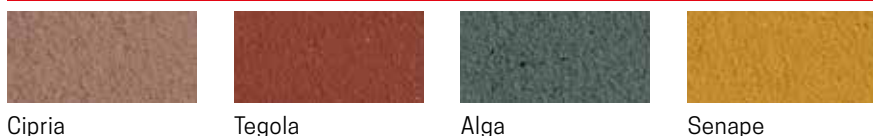

Numero pannelli	
1-2 PANNELLI	
3-4 PANNELLI	





STILE



VASCA BIANCO MORBIDO CON PANNELLI BIANCO RIGATO



VASCA BIANCO MORBIDO CON PANNELLI BURLINGTON

## SENSE 2.0 | FINITURE PANNELLI

### ACRILICO



Bianco lucido

Bianco morbido

### LEGNO



Bianco rigato

Grain

Burlington

Dolomite

### ARGILLA

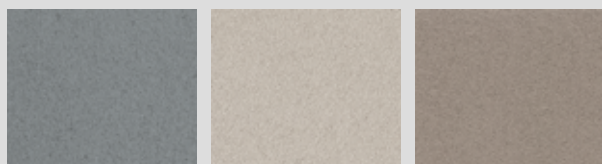

Cenere

Polvere

Tortora

### MDI



Umbra

Sabbia

## SENSE 3-4 2.0 | FUNZIONI E DOTAZIONI (disponibili a seconda dell'allestimento)

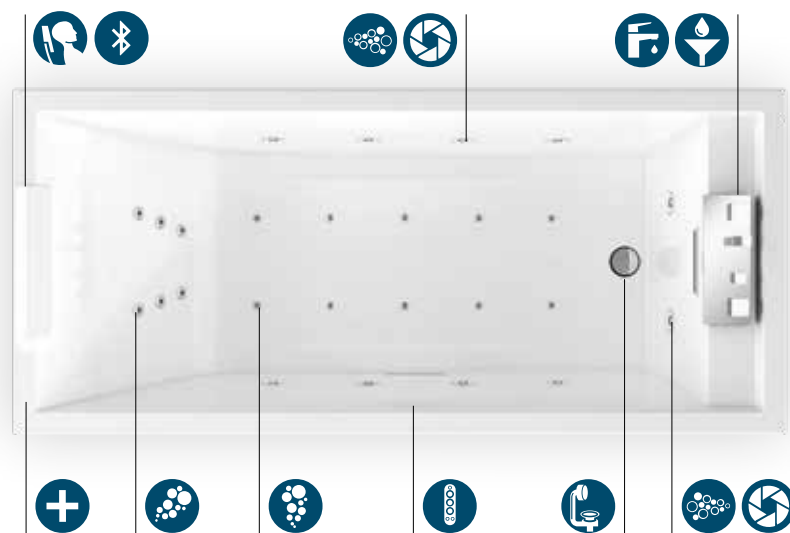

**Massaggio Airpool (10-16 jets)** a getto d'aria con accensione manuale on/off. Per una **efficace stimolazione cellulare**.



**Massaggio corpo Whirlpool (8/10 jets)** aria/acqua con regolazione di tempo e intensità manuale o automatica. Per soddisfare qualsiasi esigenza di benessere. **Cromolight** con 8 variazioni cromatiche per attivare la mente ed emozionare lo spirito.



**Massaggio Whirlpool dorsale (6 jets)** aria/acqua.



**Pannello di controllo** con funzioni Hydro Sequence



**Poggiatesta** in materiale antibatterico



**Rubinetteria bordo vasca** con tubo di scarico salvagoccia



**Disinfezione**



**Bluetooth**



**Colonna di scarico**





VASCA BIANCO MORBIDO CON PANNELLI ARGILLA POLVERE



Rubinetteria bordo vasca con tubo di scarico salvagoccia



Bocchetta idromassaggio cromata



Pannello di comando capacitivo



Poggiatesta in materiale atossico e idrorepellente

SENSE 2.0

# SENSE 2.0



# SENSE 3 2.0

VASCA RETTANGOLARE  
FONDO CHAISE LONGUE



SENSE 3 2.0

Misure			Capacità	Codice	Scelta rubinetteria + finitura vasca				Scelta struttura/pannelli	
Cm	H	Lt.			Colonna di scarico senza rubinetteria		Colonna di scarico + rubinetteria bordo vasca		Solo struttura	Con pannelli
					Bianco lucido	Bianco morbido	Bianco lucido	Bianco morbido		

## STANDARD DA INCASSO

				0-A	0-U	2-A	2-U	0K	
170 X 70	62	205	<b>S23117970</b>						
170 X 75	62	225	<b>S23117975</b>						
180 X 80	62	250	<b>S23118980</b>						
190 X 80	62	265	<b>S23119980</b>						

## STANDARD CON TELAIO

				0-A	0-U	2-A	2-U	0K	* Vedi tabella SCELTA FINITURA PANNELLO
170 X 70	62	205	<b>S23217970</b>						
170 X 75	62	225	<b>S23217975</b>						
180 X 80	62	250	<b>S23218980</b>						
190 X 80	62	265	<b>S23219980</b>						

## HYDRO AIR

				0-A	0-U	2-A	2-U	0K	* Vedi tabella SCELTA FINITURA PANNELLO
170 X 70	62	205	<b>S23Y179700</b>						
170 X 75	62	225	<b>S23Y179750</b>						
180 X 80	62	250	<b>S23Y189800</b>						
190 X 80	62	265	<b>S23Y199800</b>						

## WHIRLPOOL+DISINFEZIONE

				0-A	0-U	2-A	2-U	0K	* Vedi tabella SCELTA FINITURA PANNELLO
170 X 70	62	205	<b>S235179700</b>						
170 X 75	62	225	<b>S235179750</b>						
180 X 80	62	250	<b>S235189800</b>						
190 X 80	62	265	<b>S235199800</b>						

## WHIRLPOOL+DISINFEZIONE+LIGHT

				0-A	0-U	2-A	2-U	0K	* Vedi tabella SCELTA FINITURA PANNELLO
170 X 70	62	205	<b>S233179700</b>						
170 X 75	62	225	<b>S233179750</b>						
180 X 80	62	250	<b>S233189800</b>						
190 X 80	62	265	<b>S233199800</b>						

## HYDRO PLUS

				0-A	0-U	2-A	2-U	0K	* Vedi tabella SCELTA FINITURA PANNELLO
170 X 70	62	205	<b>S234179700</b>						
170 X 75	62	225	<b>S234179750</b>						
180 X 80	62	250	<b>S234189800</b>						
190 X 80	62	265	<b>S234199800</b>						

## WHIRLPOOL+NATURAL AIR

				0-A	0-U	2-A	2-U	0K	* Vedi tabella SCELTA FINITURA PANNELLO
170 X 70	62	205	<b>S23P179700</b>						
170 X 75	62	225	<b>S23P179750</b>						
180 X 80	62	250	<b>S23P189800</b>						
190 X 80	62	265	<b>S23P199800</b>						



Scelta numero pannelli				Scelta finitura pannelli / prezzo					
				ACRILICO		LEGNI			
1 frontale	1 frontale + 1 laterale	1 frontale + 2 laterali	2 frontali + 2 laterali	Bianco Lucido	Bianco morbido	Bianco rigato	Grain	Burlington	Dolomite
1	2	3	4	A	U	I	M	N	X
	-	-	-						
-		-	-						
-	-		-						
-	-	-							

Costruzione codice vasca senza pannelli **Codice** + **Scelta scarico/erogazione + Finitura vasca** + **Scelta struttura senza pannelli** = Codice prodotto finale

Costruzione codice vasca con pannelli **Codice** + **Scelta scarico/erogazione + Finitura vasca** + **Scelta struttura con pannelli (acrilico o legni)** = Codice prodotto finale

**PER LA VERSIONE CON I PANNELLI IN FINITURA ARGILLA ORDINARE: 1 CODICE VASCA SOLO STRUTTURA + 1 CODICE PANNELLI ARGILLA**

Misure	Scelta numero pannelli				ARGILLA			MDI	
					Cenere	Polvere	Tortora	Umbr	Sabbia
	1 frontale	1 frontale + 1 laterale	1 frontale + 2 laterali	2 frontali + 2 laterali	R	O	S	1	2
170 x 70; 170 x 75	<b>PANVFDI179-</b>	-	-	-					
180 x 80	<b>PANVFDI189-</b>	-	-	-					
190 x 80	<b>PANVFDI199-</b>	-	-	-					
170 x 70	-	<b>PANV1F1LDI17970-</b>	-	-					
170 x 75	-	<b>PANV1F1LDI17975-</b>	-	-					
180 x 80	-	<b>PANV1F1LDI18980-</b>	-	-					
190 x 80	-	<b>PANV1F1LDI19980-</b>	-	-					
170 x 70	-	-	<b>PANV1F2LDI17970-</b>	-					
170 x 75	-	-	<b>PANV1F2LDI17975-</b>	-					
180 x 80	-	-	<b>PANV1F2LDI18980-</b>	-					
190 x 80	-	-	<b>PANV1F2LDI19980-</b>	-					
170 x 70	-	-	-	<b>PANV2F2LDI17970-</b>					
170 x 75	-	-	-	<b>PANV2F2LDI17975-</b>					
180 x 80	-	-	-	<b>PANV2F2LDI18980-</b>					
190 x 80	-	-	-	<b>PANV2F2LDI19980-</b>					

**COLORI SPECIALI SU RICHIESTA PER PANNELLI ARGILLA**

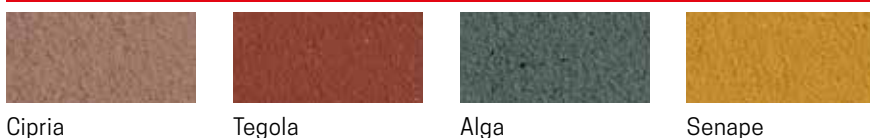

Numero pannelli	
1-2 PANNELLI	
3-4 PANNELLI	

SENSE 2.0



# SENSE 4 2.0

VASCA RETTANGOLARE  
FONDO PIATTO



SENSE 4 2.0

Misure			Capacità	Codice	Scelta rubinetteria + finitura vasca				Scelta struttura/pannelli	
Cm	H	Lt.			Colonna di scarico senza rubinetteria		Colonna di scarico + rubinetteria bordo vasca		Solo struttura	Con pannelli
					Bianco lucido	Bianco morbido	Bianco lucido	Bianco morbido		

## STANDARD DA INCASSO

				0-A	0-U	2-A	2-U	0K	
170 X 70	62	215	<b>S24117970</b>						
170 X 75	62	235	<b>S24117975</b>						
180 X 80	62	265	<b>S24118980</b>						
190 X 80	62	280	<b>S24119980</b>						

## STANDARD CON TELAIO

				0-A	0-U	2-A	2-U	0K	
170 X 70	62	215	<b>S24217970</b>						* Vedi tabella <b>SCELTA FINITURA PANNELLO</b>
170 X 75	62	235	<b>S24217975</b>						
180 X 80	62	265	<b>S24218980</b>						
190 X 80	62	280	<b>S24219980</b>						

## HYDRO AIR

				0-A	0-U	2-A	2-U	0K	
170 X 70	62	215	<b>S24Y179700</b>						* Vedi tabella <b>SCELTA FINITURA PANNELLO</b>
170 X 75	62	235	<b>S24Y179750</b>						
180 X 80	62	265	<b>S24Y189800</b>						
190 X 80	62	280	<b>S24Y199800</b>						

## WHIRLPOOL+DISINFEZIONE

				0-A	0-U	2-A	2-U	0K	
170 X 70	62	215	<b>S245179700</b>						* Vedi tabella <b>SCELTA FINITURA PANNELLO</b>
170 X 75	62	235	<b>S245179750</b>						
180 X 80	62	265	<b>S245189800</b>						
190 X 80	62	280	<b>S245199800</b>						

## WHIRLPOOL+DISINFEZIONE+LIGHT

				0-A	0-U	2-A	2-U	0K	
170 X 70	62	215	<b>S243179700</b>						* Vedi tabella <b>SCELTA FINITURA PANNELLO</b>
170 X 75	62	235	<b>S243179750</b>						
180 X 80	62	265	<b>S243189800</b>						
190 X 80	62	280	<b>S243199800</b>						

## HYDRO PLUS

				0-A	0-U	2-A	2-U	0K	
170 X 70	62	215	<b>S244179700</b>						* Vedi tabella <b>SCELTA FINITURA PANNELLO</b>
170 X 75	62	235	<b>S244179750</b>						
180 X 80	62	265	<b>S244189800</b>						
190 X 80	62	280	<b>S244199800</b>						

## WHIRLPOOL+NATURAL AIR

				0-A	0-U	2-A	2-U	0K	
170 X 70	62	215	<b>S24P179700</b>						* Vedi tabella <b>SCELTA FINITURA PANNELLO</b>
170 X 75	62	235	<b>S24P179750</b>						
180 X 80	62	265	<b>S24P189800</b>						
190 X 80	62	280	<b>S24P199800</b>						



Scelta numero pannelli				Scelta finitura pannelli / prezzo					
				ACRILICO		LEGNI			
				Bianco Lucido	Bianco morbido	Bianco rigato	Grain	Burlington	Dolomite
1 frontale	1 frontale + 1 laterale	1 frontale + 2 laterali	2 frontali + 2 laterali	A	U	I	M	N	X
	-	-	-						
-		-	-						
-	-		-						
-	-	-							

Costruzione codice vasca senza pannelli **Codice** + **Scelta scarico/erogazione + Finitura vasca** + **Scelta struttura senza pannelli** = Codice prodotto finale

Costruzione codice vasca con pannelli **Codice** + **Scelta scarico/erogazione + Finitura vasca** + **Scelta struttura con pannelli (acrilico o legni)** = Codice prodotto finale

**PER LA VERSIONE CON I PANNELLI IN FINITURA ARGILLA ORDINARE: 1 CODICE VASCA SOLO STRUTTURA + 1 CODICE PANNELLI ARGILLA**

Misure	Scelta numero pannelli				ARGILLA			MDI	
					Cenere	Polvere	Tortora	Umbr	Sabbia
	1 frontale	1 frontale + 1 laterale	1 frontale + 2 laterali	2 frontali + 2 laterali	R	O	S	1	2
170 x 70; 170 x 75	<b>PANVFDI179-</b>	-	-	-					
180 x 80	<b>PANVFDI189-</b>	-	-	-					
190 x 80	<b>PANVFDI199-</b>	-	-	-					
170 x 70	-	<b>PANV1F1LDI17970-</b>	-	-					
170 x 75	-	<b>PANV1F1LDI17975-</b>	-	-					
180 x 80	-	<b>PANV1F1LDI18980-</b>	-	-					
190 x 80	-	<b>PANV1F1LDI19980-</b>	-	-					
170 x 70	-	-	<b>PANV1F2LDI17970-</b>	-					
170 x 75	-	-	<b>PANV1F2LDI17975-</b>	-					
180 x 80	-	-	<b>PANV1F2LDI18980-</b>	-					
190 x 80	-	-	<b>PANV1F2LDI19980-</b>	-					
170 x 70	-	-	-	<b>PANV2F2LDI17970-</b>					
170 x 75	-	-	-	<b>PANV2F2LDI17975-</b>					
180 x 80	-	-	-	<b>PANV2F2LDI18980-</b>					
190 x 80	-	-	-	<b>PANV2F2LDI19980-</b>					

**COLORI SPECIALI SU RICHIESTA PER PANNELLI ARGILLA**

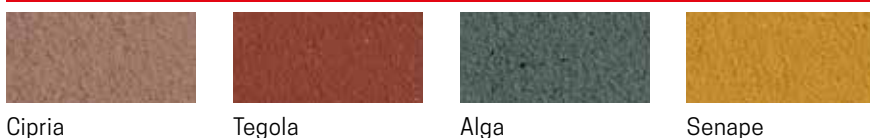

Numero pannelli	
1-2 PANNELLI	
3-4 PANNELLI	

SENSE 2.0



VERSIONE CENTRO PARETE FINITURA ARGILLA CENERE



VERSIONE AD ANGOLO FINITURA PANNELLI DOLOMITE

## DIVINA W | FINITURE PANNELLI

### ACRILICO



Bianco lucido

Bianco morbido

### LEGNO

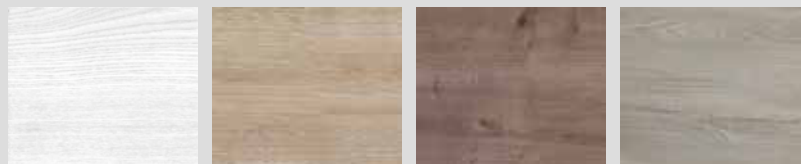

Bianco rigato

Grain

Burlington

Dolomite

### ARGILLA

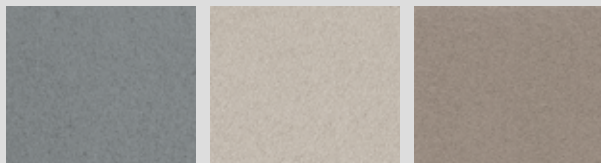

Cenere

Polvere

Tortora

## DIVINA W | FUNZIONI E DOTAZIONI (disponibili a seconda dell'allestimento)



**Massaggio Airpool (16 jets)** a getto d'aria con accensione manuale on/off. Per una **efficace stimolazione cellulare**.



**Massaggio corpo Whirlpool (6 jets)** aria/acqua con regolazione di tempo e intensità manuale o automatica. Per soddisfare qualsiasi esigenza di benessere.



**Natural air**



**Cromolight** con 8 variazioni cromatiche per attivare la mente ed emozionare lo spirito.



**Accensione soft-touch.**



**Poggiatesta** in materiale antibatterico.



**Rubinetteria bordo vasca** con cascata e tubo di scarico salvagoccia.



**Colonna di scarico con piletta** click-clack.



DISPONIBILITÀ MARZO 2022



VERSIONE AD ANGOLO



Avvolgere il corpo con una soffice nuvola d'ossigeno grazie al sistema Natural Air

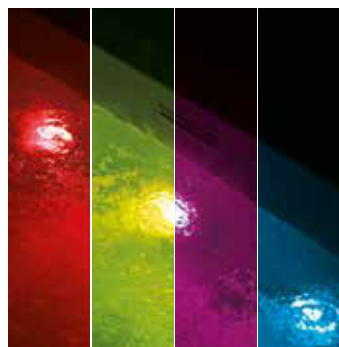

Bocchette Whirlpool con Cromolight integrata per stimolare corpo ed emozioni



Accensione soft-touch con comando capacitivo sul bordo della vasca



Rubinetto

DIVINA W

# DIVINA W

# DIVINA W

## VASCA RETTANGOLARE

Misure			Capacità	Codice	Scelta rubinetteria + finitura vasca						Scelta struttura / Pannello	
Cm	H	Lt.			Colonna di scarico senza rubinetteria		Colonna di scarico con erogazione da troppo pieno		Colonna di scarico + rubinetteria bordo vasca		Senza pannelli	Con pannelli
					Bianco lucido	Bianco morbido	Bianco lucido	Bianco morbido	Bianco lucido	Bianco morbido		

STANDARD DA INCASSO												
				0-A	0-U	1-A	1-U	2-A	2-U	0K		
180 X 80	63	320	<b>DI11808W</b>									
STANDARD CON TELAIO												
180 X 80	63	320	<b>DI21808W</b>								* Vedi tabella <b>SCELTA                      FINITURA                      PANNELLO</b>	
HYDRO AIR												
180 X 80	63	320	<b>DIY1808WO</b>								* Vedi tabella <b>SCELTA                      FINITURA                      PANNELLO</b>	
WHIRLPOOL												
180 X 80	63	320	<b>DI51808WO</b>								* Vedi tabella <b>SCELTA                      FINITURA                      PANNELLO</b>	
HYDRO PLUS												
180 X 80	63	320	<b>DI41808WO</b>								* Vedi tabella <b>SCELTA                      FINITURA                      PANNELLO</b>	
NATURAL AIR												
180 X 80	63	320	<b>DIN1808WO</b>								* Vedi tabella <b>SCELTA                      FINITURA                      PANNELLO</b>	
NATURAL AIR + WHIRLPOOL												
180 X 80	63	320	<b>DIP1808WO</b>								* Vedi tabella <b>SCELTA                      FINITURA                      PANNELLO</b>	







VERSIONE CENTRO PARETE

Scelta numero pannelli	Scelta finitura pannelli /prezzo								
	ACRILICO		LEGNI				ARGILLA		
	Bianco Lucido	Bianco morbido	Bianco rigato	Grain	Burlington	Dolomite	Cenere	Polvere	Tortora
1 pannello centro parete	<b>CA</b>	<b>CU</b>	<b>CI</b>	<b>CM</b>	<b>CN</b>	<b>CX</b>	<b>CR</b>	<b>CO</b>	<b>CS</b>
1 pannello angolo destro	<b>DA</b>	<b>DU</b>	<b>DI</b>	<b>DM</b>	<b>DN</b>	<b>DX</b>	<b>DR</b>	<b>DO</b>	<b>DS</b>
1 pannello angolo sinistro	<b>SA</b>	<b>SU</b>	<b>SI</b>	<b>SM</b>	<b>SN</b>	<b>SX</b>	<b>SR</b>	<b>SO</b>	<b>SS</b>

Costruzione codice vasca senza pannelli **Codice** + **Scelta scarico/erogazione + Finitura vasca** + **Scelta struttura senza pannelli** = Codice prodotto finale

Costruzione codice vasca con pannelli **Codice** + **Scelta scarico/erogazione + Finitura vasca** + **Scelta struttura con pannelli (laminato o argilla)** = Codice prodotto finale



**COLORI SPECIALI SU RICHIESTA PER PANNELLI ARGILLA**



Cipria Tegola Alga Senape

PANNELLI	
1 pannello angolo	
1 pannello centro parete	

DIVINA W

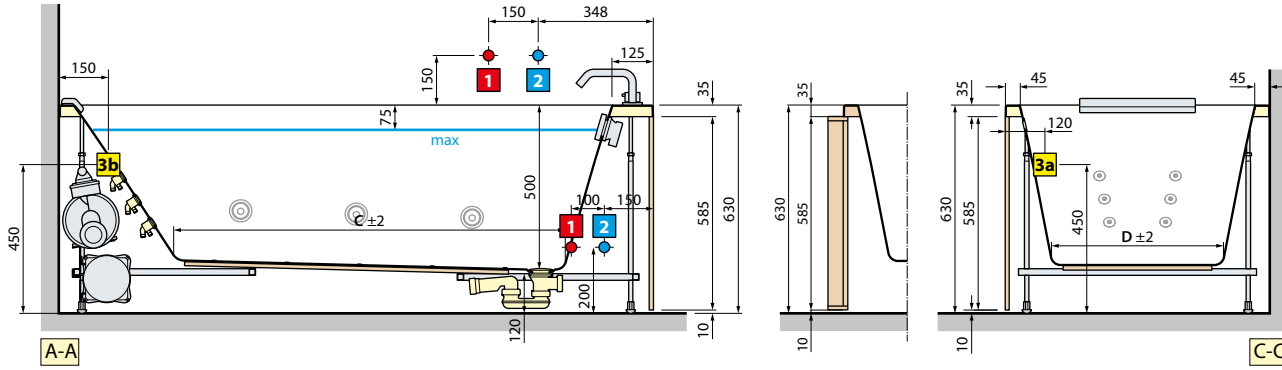

IN CASO DI PANNELLI FRAME

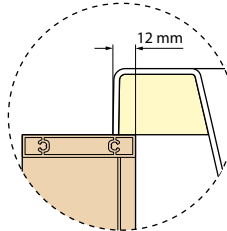

IN CASO DI INCASSO

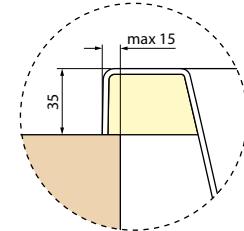

INGOMBRO CON PANNELLI FRAME

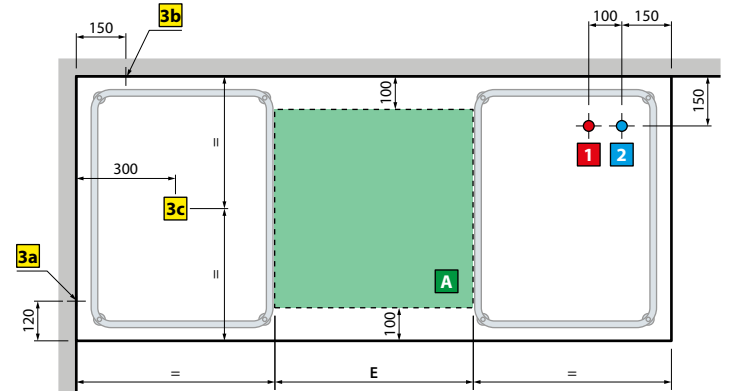
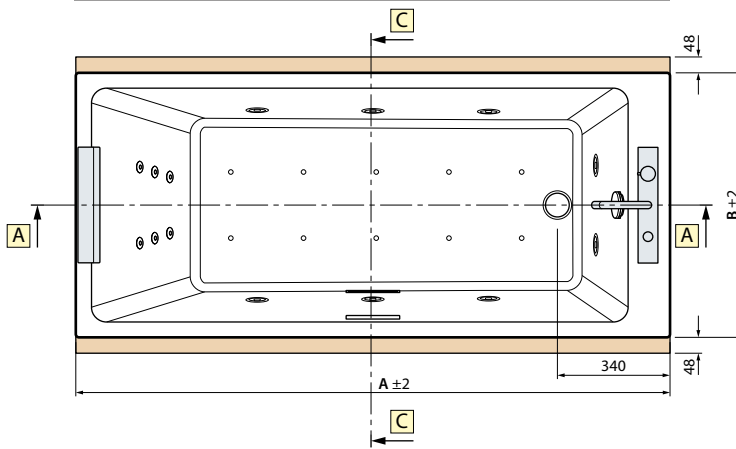

modello	A	B	C	D	E	Capacità litri
<b>170x70</b>	1700	700	1080	420	500	250
<b>170x75</b>	1700	750	1080	470	500	280
<b>180x80</b>	1800	800	1180	520	600	330

POTENZE ELETTRICHE

	HYDRO AIR	WHIRLPOOL	HYDRO PLUS	NATURAL AIR	WHIRLPOOL+NATURAL AIR
riscaldatore	—	—	—	—	—
whirlpool	—	550 W	900 W	—	550 W
airpool	400 W	—	400 W	—	—
natural air	—	—	—	1.050 W	1.050 W
<b>TOTALE</b>	<b>400 W</b>	<b>550 W</b>	<b>1.300 W</b>	<b>1.050 W</b>	<b>1.050 W</b>

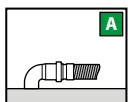

Installare a monte dell'apparecchio un interruttore differenziale da 30mA provvisto di interruttore onnipolare con apertura minima dei contatti > 3mm.

**CARATTERISTICHE IDRAULICHE**  
Allaccio sifone con raccordo 1 1/2"

**CARATTERISTICHE ELETTRICHE**  
Tensione 220-230 V  
Frequenza 50 Hz

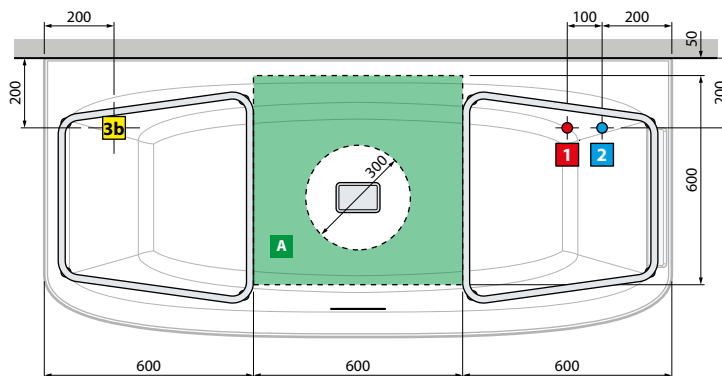
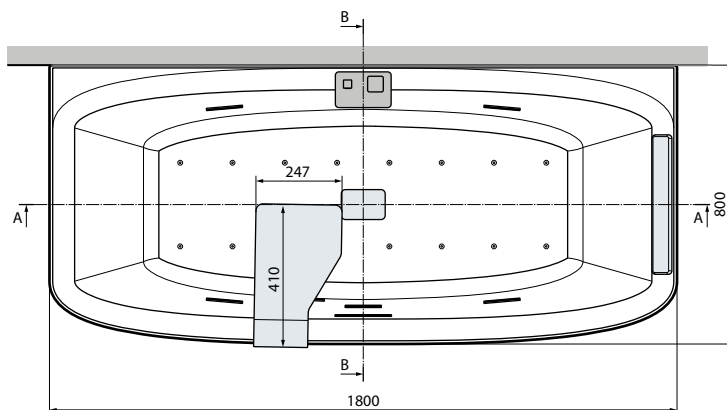
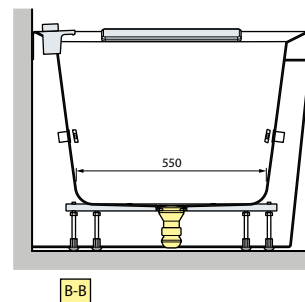
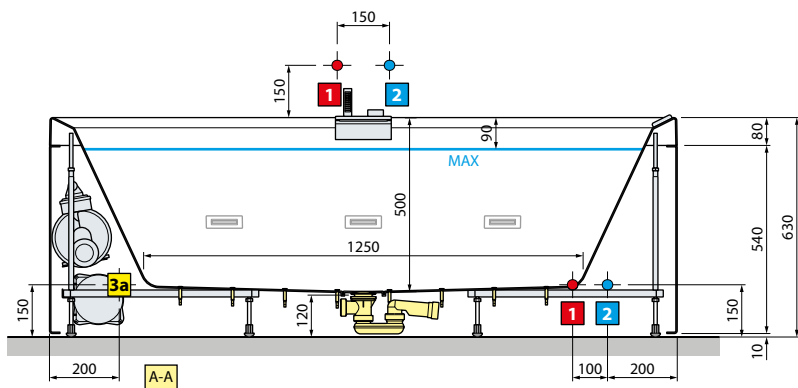

## VERSIONE SINISTRA

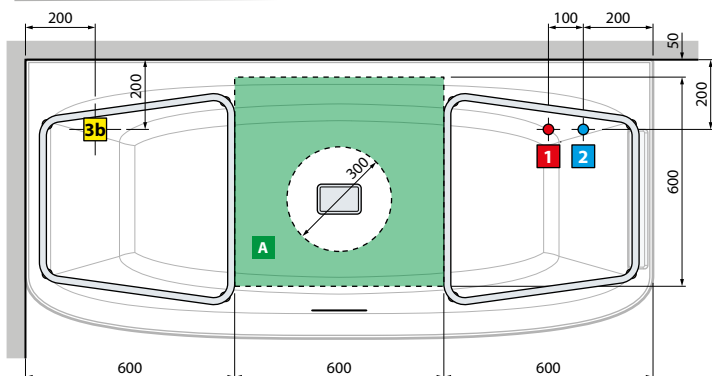

## VERSIONE DESTRA

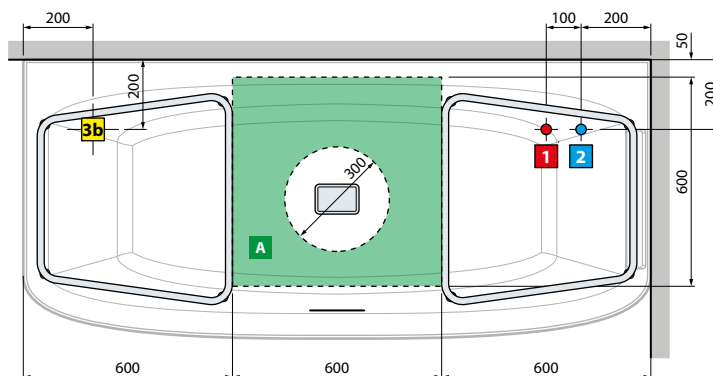

### Capacità litri

320

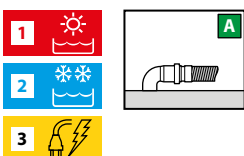

### CARATTERISTICHE IDRAULICHE

16 bocchette airpool  
6 bocchette whirlpool  
Allaccio sifone con raccordo 1 1/2"

### CARATTERISTICHE ELETTRICHE

Tensione 220-230 V  
Frequenza 50 Hz  
Potenza massima assorbita:  
Whirlpool: 900 W  
Airpool: 400 W  
Plus: 1300 W  
Natural Air: 1050 W

Installare a monte dell'apparecchio un interruttore differenziale da 30mA provvisto di interruttore onnipolare con apertura minima dei contatti  $\geq 3$  mm.



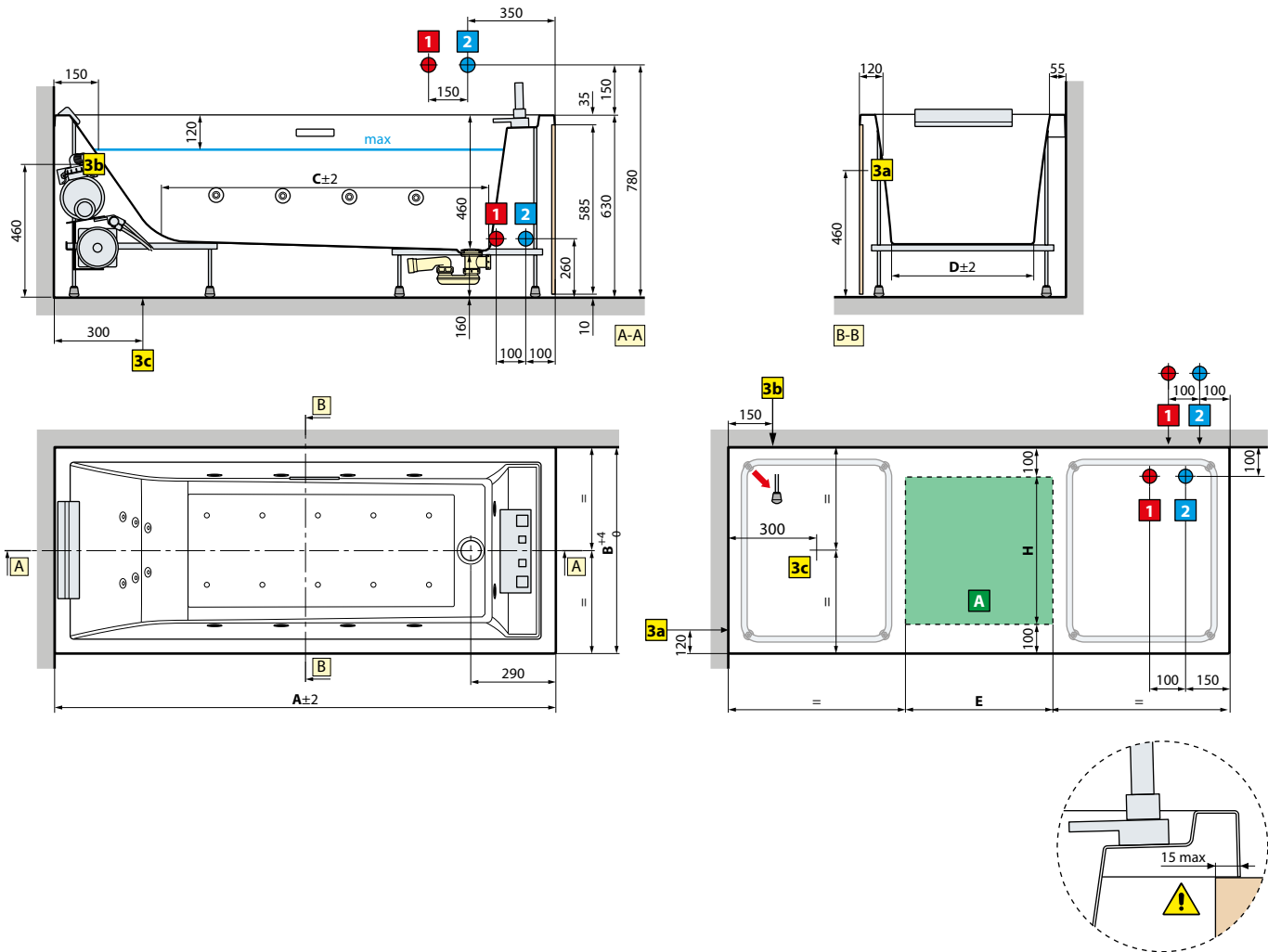

modello	A	B	C	D	E	Capacità litri
<b>170x70</b>	1700	700	1107	475	500	215
<b>170x75</b>	1700	750	1107	525	500	235
<b>180x80</b>	1800	800	1142	575	600	265
<b>190x80</b>	1900	800	1173	575	700	280

**POTENZE ELETTRICHE**

	HYDRO AIR	WHIRLPOOL + DISINFEZIONE	WHIRLPOOL DISINFEZIONE + LIGHT	HYDRO PLUS	WHIRLPOOL + NATURAL AIR
<b>riscaldatore</b>	—	—	—	1.300 W	—
<b>whirlpool</b>	—	550 W	550 W	900 W	550 W
<b>airpool</b>	400 W	—	—	400 W	—
<b>natural air</b>	—	—	—	—	1.050 W
<b>TOTALE</b>	<b>400 W</b>	<b>550 W</b>	<b>550 W</b>	<b>2.600 W</b>	<b>1.050 W</b>

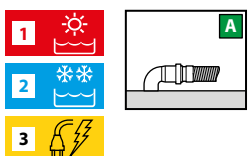

Installare a monte dell'apparecchio un interruttore differenziale da 30mA provvisto di interruttore onnipolare con apertura minima dei contatti  $\geq 3$  mm.

**CARATTERISTICHE IDRAULICHE**  
Allaccio sifone con raccordo 1 1/2"

**CARATTERISTICHE ELETTRICHE**  
Tensione 220-230 V  
Frequenza 50 Hz

DISEGNI TECNICI





# Complementi



Il perfetto accessorio  
per tutti i nostri prodotti bagno.



## Elementi adattabili a mobili standard

Ogni complemento è progettato per valorizzare uno stile coordinato e funzionale.



## Arricchimento collection Frame

La vasta selezione di accessori dona all'ambiente bagno una personalità decisa



# ACCESSORI FRAME

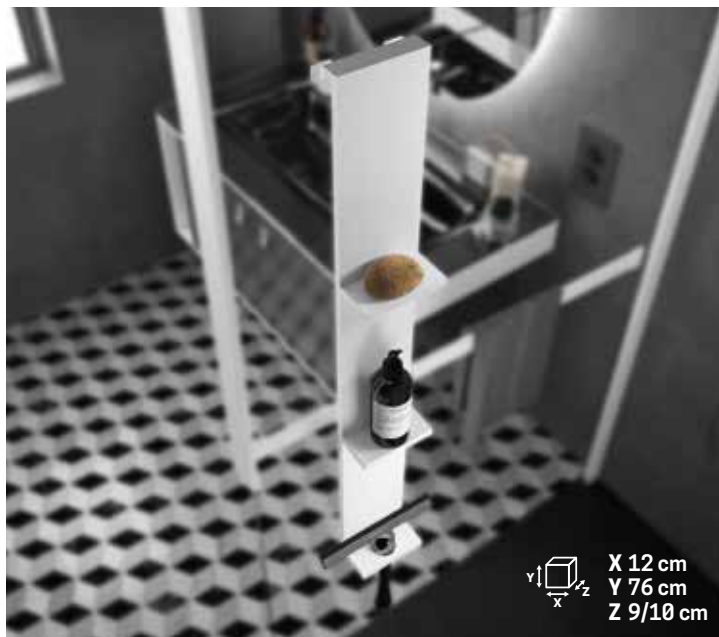

X 12 cm  
Y 76 cm  
Z 9/10 cm

## ACCESSORIO DA AGGANCIARE AL VETRO CON MENSOLE + PORTA-TERGIVETRO E APPENDIABITI ESTERNO (Tergivetro non incluso)

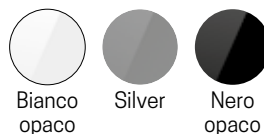

Misure (cm)	Codice	Scelta finitura / prezzo		
		U	B	H
12 x 76	<b>R90AKFP01290-</b>	Bianco opaco	Silver	Nero opaco



X 35 cm  
Y 90 cm  
Z 8,5/8,5 cm

## MENSOLE INTERNA E PORTA SALVIETTE ESTERNO DA AGGANCIARE AL VETRO

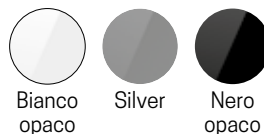

Misure (cm)	Codice	Scelta finitura / prezzo		
		U	B	H
35 x 90	<b>R90AKFPSP03590-</b>	Bianco opaco	Silver	Nero opaco



X 35 cm  
Y 90 cm  
Z 8,5 cm

## TRE MENSOLE INTERNE E APPENDIABITI ESTERNO DA AGGANCIARE AL VETRO



Misure (cm)	Codice	Scelta finitura / prezzo		
		U	B	H
35 x 90	<b>R90AKFP03590-</b>	Bianco opaco	Silver	Nero opaco



### MENSOLA INTERNA E APPENDIABITI ESTERNO DA AGGANCIARE AL VETRO



Misure (cm)	Codice	Scelta finitura / prezzo		
		U	B	H
		Bianco opaco	Silver	Nero opaco
40 x 60	<b>R90AKFP04070-</b>			



### MENSOLA



Misure (cm)	Codice	Scelta finitura / prezzo		
		U	B	H
		Bianco opaco	Silver	Nero opaco
9,7 x 17,5	<b>R90AKFME17-</b>			
9,7 x 30	<b>R90AKFME30-</b>			
9,7 x 45	<b>R90AKFME45-</b>			



### PORTA SAPONE DA APPOGGIO IN SOLID SURFACE (mensola non inclusa)



Misure (cm)	Codice	Scelta finitura / prezzo
		<b>U</b>
		Bianco opaco
9,7 x 12	<b>R90AKFBS01-</b>	

# ACCESSORI FRAME



## MENSOLA CON FORO PORTA-TERGIVETRO

(tergivetrol non incluso)



Misure (cm)	Codice	Scelta finitura / prezzo		
		U	B	H
9,7 x 30	<b>R90AKFMPR30-</b>	Bianco opaco	Silver	Nero opaco
9,7 x 45	<b>R90AKFMPR45-</b>			

TERGIVETRO in metallo cromato e gomma

Codice	Prezzo
<b>R90RACLA0B</b>	



## MENSOLA CON BICCHIERE E DOSATORE PER SAPONE



Misure (cm)	Codice	Scelta finitura / prezzo		
		U	B	H
9,7 x 30	<b>R90AKFMPB30-</b>	Bianco opaco	Silver	Nero opaco
9,7 x 45	<b>R90AKFMPB45-</b>			



## MENSOLA CON FRONTALE



Misure (cm)	Codice	Scelta finitura / prezzo		
		U	B	H
10,9 x 35	<b>R90AKFMMA135-</b>	Bianco opaco	Silver	Nero opaco
10,9 x 50	<b>R90AKFMMA150-</b>			
10,9 x 65	<b>R90AKFMMA165-</b>			



NOVITÀ 2022



◀ **MENSOLA CON BATTUTA E PORTA SALVIETTE A SBALZO**

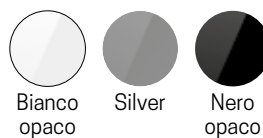

Misure (cm)	Codice	Scelta finitura / prezzo		
		U	B	H
		Bianco opaco	Silver	Nero opaco
10,9 x 80	<b>R90AKFMMA380-</b>			
10,9 x 120	<b>R90AKFMMA3120-</b>			
10,9 x 140	<b>R90AKFMMA3140-</b>			

X 80/120/140 cm  
Y 8,5 cm  
Z 10,9 cm

NOVITÀ 2022



◀ **MENSOLA L. 70 E 80 CM CON FRONTALE A SBALZO, PORTA SALVIETTE E CON BICCHIERE E DOSATORE PER SAPONE**

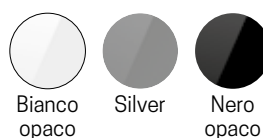

Misure (cm)	Codice	Destra	Sinistra	Scelta finitura / prezzo		
		D-	S-	U	B	H
				Bianco opaco	Silver	Nero opaco
10,9x100	<b>R90AKFMMA2100F</b>	D-	S-			
10,9x110	<b>R90AKFMMA2110F</b>	D-	S-			

X 100/110 cm  
Y 8,5 cm  
Z 10,9 cm

NOVITÀ 2022



◀ **MENSOLA L. 70 E 80 CM CON FRONTALE A SBALZO PORTA SALVIETTE**

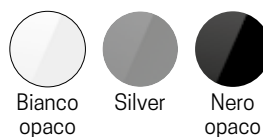

Misure (cm)	Codice	Destra	Sinistra	Scelta finitura / prezzo		
		D-	S-	U	B	H
				Bianco opaco	Silver	Nero opaco
10,9 x 100	<b>R90AKFMMA2100</b>	D-	S-			
10,9 x 110	<b>R90AKFMMA2110</b>	D-	S-			

X 100/110 cm  
Y 8,5 cm  
Z 10,9 cm

# ACCESSORI FRAME



## MENSOLA IN SOVRAPPOSIZIONE FORATA PER SPECCHIO

(specchio non incluso)



Misure (cm)	Codice	Scelta finitura / prezzo		
		U	B	H
		Bianco opaco	Silver	Nero opaco
12,5 x 85	<b>R90AKFMS85-</b>			
12,5 x 110	<b>R90AKFMS110-</b>			



## MENSOLA IN SOVRAPPOSIZIONE FORATA PER SPECCHIO CON BICCHIERE E DOSATORE PER SAPONE

(specchio non incluso)

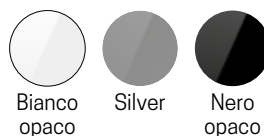

Misure (cm)	Codice	Destra	Sinistra	Scelta finitura / prezzo		
		D-	S-	U	B	H
				Bianco opaco	Silver	Nero opaco
12,5 x 85	<b>R90AKFMSF85</b>	D-	S-			
12,5 x 110	<b>R90AKFMSF110</b>	D-	S-			



## MENSOLA DOGATA PORTA ASCIUGAMANI



Misure (cm)	Codice	Scelta finitura / prezzo		
		U	B	H
		Bianco opaco	Silver	Nero opaco
35 x 61,2	<b>R90AKFPA-</b>			



### PORTA SALVIETTE

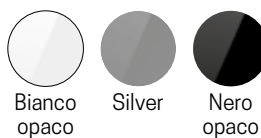

Misure (cm)	Codice	Scelta finitura / prezzo		
		U	B	H
9 x 30	<b>R90AKFPS0130-</b>	Bianco opaco	Silver	Nero opaco
9 x 45	<b>R90AKFPS0145-</b>			
9 x 60	<b>R90AKFPS0160-</b>			



### PORTA SALVIETTE DOPPIO



Misure (cm)	Codice	Scelta finitura / prezzo		
		U	B	H
10 x 30	<b>R90AKFPS0230-</b>	Bianco opaco	Silver	Nero opaco
10 x 45	<b>R90AKFPS0245-</b>			
10 x 60	<b>R90AKFPS0260-</b>			



### PORTA SALVIETTE CON MENSOLA INTERNA

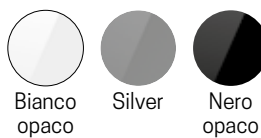

Misure (cm)	Codice	Scelta finitura / prezzo		
		U	B	H
12 x 30	<b>R90AKFMPS30-</b>	Bianco opaco	Silver	Nero opaco
12 x 45	<b>R90AKFMPS45-</b>			
12 x 60	<b>R90AKFMPS60-</b>			

# ACCESSORI FRAME

NOVITÀ 2022



X 40 cm  
Y 4,2 cm  
Z 6 cm

## PORTA SALVIETTE FIANCO MOBILE



Misure (cm)	Codice	Scelta finitura / prezzo		
		U	B	H
		Bianco opaco	Silver	Nero opaco
6 x 40	<b>R90AKFMPS140-</b>			



X 6 cm  
Y 4 cm  
Z 3,3 cm

## APPENDIABITI A MURO



Misure (cm)	Codice	Scelta finitura / prezzo		
		U	B	H
		Bianco opaco	Silver	Nero opaco
6 x 4	<b>R90AKFPAQM-</b>			

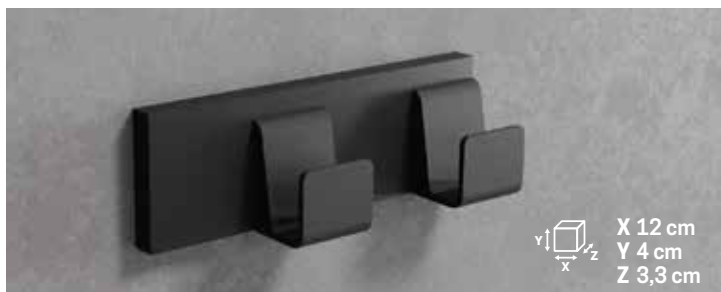

X 12 cm  
Y 4 cm  
Z 3,3 cm

## APPENDIABITI DOPPIO

12 x 4	<b>R90AKFPAQM2-</b>			
--------	---------------------	--	--	--



X 21,2 cm  
Y 16,1 cm  
Z 9,7 cm



X 21,2 cm  
Y 31,1 cm  
Z 9,7 cm

## PORTAROTOLO SINGOLO / DOPPIO



### PORTAROTOLO SINGOLO

Misure (cm)	Codice	Scelta finitura / prezzo		
		U	B	H
		Bianco opaco	Silver	Nero opaco
16,2 x 21,2	<b>R90AKFPR16-</b>			

### PORTAROTOLO DOPPIO

31,2 x 21,2	<b>R90AKFPR31-</b>			
-------------	--------------------	--	--	--





X 21,2 cm  
Y 75 cm  
Z 9,7 cm

### PORTA ROTOLO SINGOLO + PORTA SCOPINO

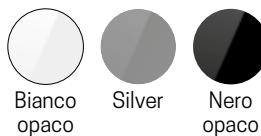

Misure (cm)	Codice	Scelta finitura / prezzo		
		U	B	H
		Bianco opaco	Silver	Nero opaco
21,2 x 75	<b>R90AKFPRS-</b>			



X 47 cm  
Y 75 cm  
Z 15 cm

### COLONNA PORTA SALVIETTE, PORTA ROTOLO E PORTA SCOPINO

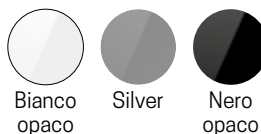

Misure (cm)	Codice	Scelta finitura / prezzo		
		U	B	H
		Bianco opaco	Silver	Nero opaco
47 x 75	<b>R90AKFPRS-</b>			



X 35 cm  
Y 75 cm  
Z 15 cm

### COLONNA PORTA SALVIETTE



Misure (cm)	Codice	Scelta finitura / prezzo		
		U	B	H
		Bianco opaco	Silver	Nero opaco
35 x 75	<b>R90AKFPS-</b>			



## ACCESSORI EDGE



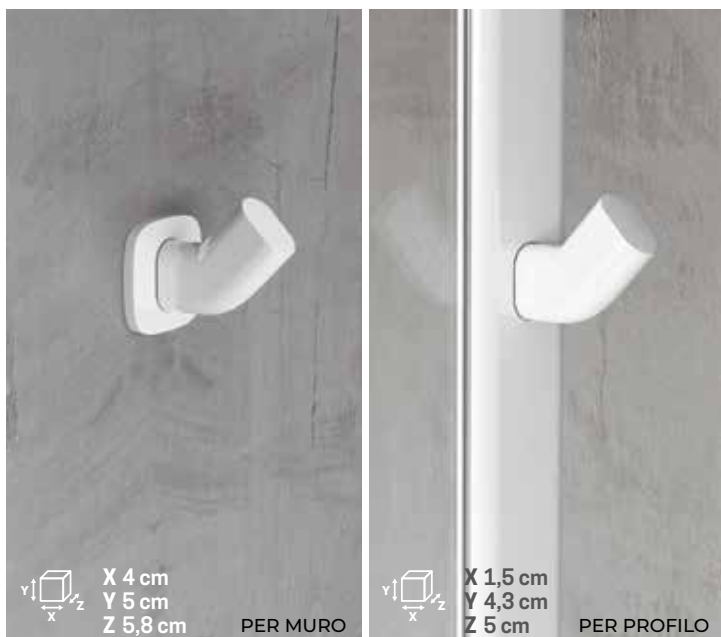

### APPENDIABITI SINGOLO

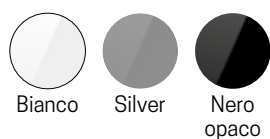

#### MURO

Codice	Scelta finitura / prezzo		
	A	B	H
	Bianco	Silver	Nero opaco
<b>R90AGEPAM-</b>			

#### PROFILO

Codice	Scelta finitura / prezzo		
	A	B	H
	Bianco	Silver	Nero opaco
<b>R90AGEPAP-</b>			

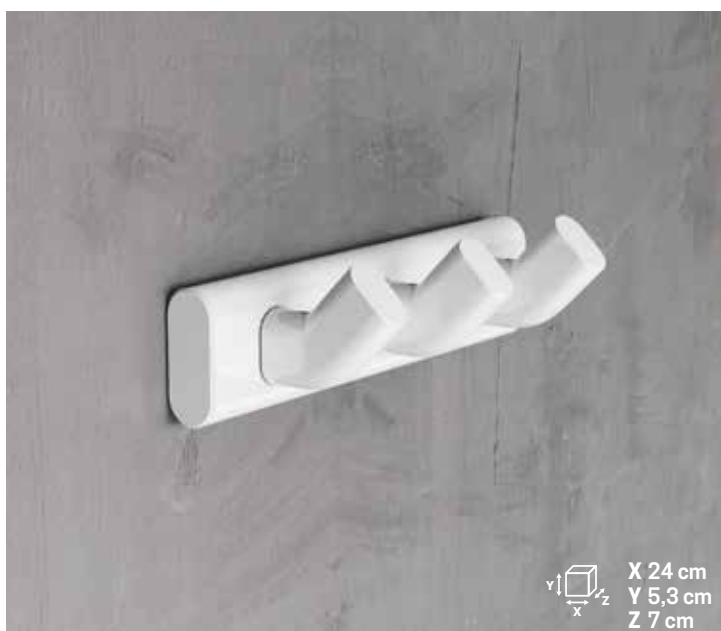

### APPENDIABITI MULTIPLO

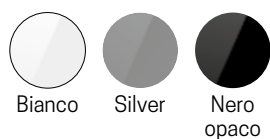

Codice	Scelta finitura / prezzo		
	A	B	H
	Bianco	Silver	Nero opaco
<b>R90AGEPAM3-</b>			

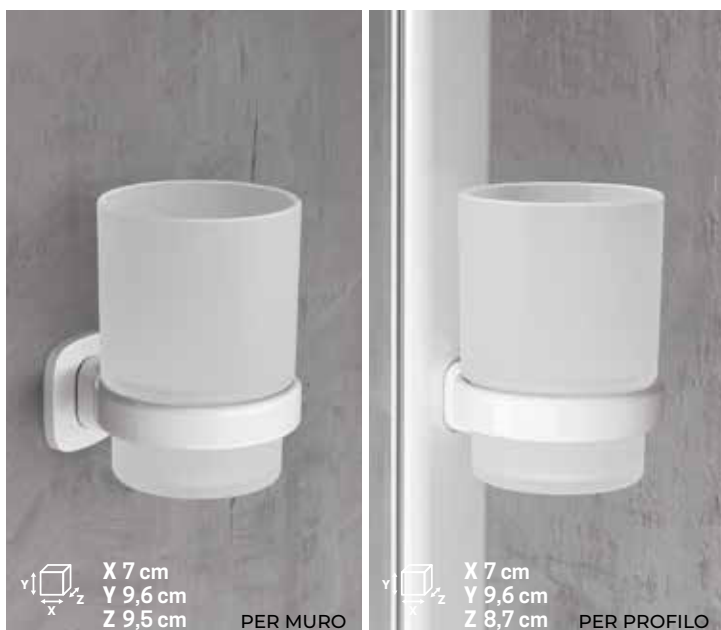

### BICCHIERE



#### MURO

Codice	Scelta finitura / prezzo		
	A	B	H
	Bianco	Silver	Nero opaco
<b>R90AGEBIM-</b>			

#### PROFILO

Codice	Scelta finitura / prezzo		
	A	B	H
	Bianco	Silver	Nero opaco
<b>R90AGEBIP-</b>			

# ACCESSORI EDGE



## DOSASAPONE



### MURO

Codice	Scelta finitura / prezzo		
	A	B	H
	Bianco	Silver	Nero opaco
<b>R90AGEDSM-</b>			

### PROFILO

Codice	Scelta finitura / prezzo		
	A	B	H
	Bianco	Silver	Nero opaco
<b>R90AGEDSP-</b>			



## PORTA-PHON

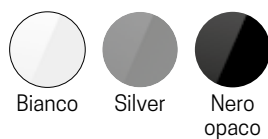

### MURO

Codice	Scelta finitura / prezzo		
	A	B	H
	Bianco	Silver	Nero opaco
<b>R90AGEPPM-</b>			



## PORTA-TERGIVETRO (tergivetrol non incluso)



### MURO

Codice	Scelta finitura / prezzo		
	A	B	H
	Bianco	Silver	Nero opaco
<b>R90AGEPRM-</b>			

### PROFILO

Codice	Scelta finitura / prezzo		
	A	B	H
	Bianco	Silver	Nero opaco
<b>R90AGEPRP-</b>			





### MENSOLA

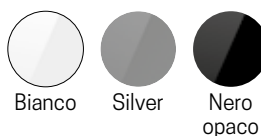

### MURO

Codice	Scelta finitura / prezzo		
	A	B	H
	Bianco	Silver	Nero opaco
<b>R90AGEMEM-</b>			

### PROFILO

Codice	Scelta finitura / prezzo		
	A	B	H
	Bianco	Silver	Nero opaco
<b>R90AGEMEP-</b>			



### PORTA-ROTOLO

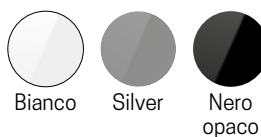

Codice	Scelta finitura / prezzo		
	A	B	H
	Bianco	Silver	Nero opaco
<b>R90AGEPT-</b>			



### PORTA-SCOPINO

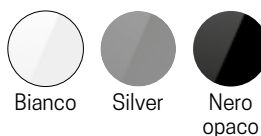

Codice	Scelta finitura / prezzo		
	A	B	H
	Bianco	Silver	Nero opaco
<b>R90AGEPS-</b>			

# ACCESSORI EDGE



X 8,5 cm  
Y 65 cm  
Z 12,2 cm

## PORTA-ROTOLO E PORTA-SCOPINO



Codice	Scelta finitura / prezzo		
	A	B	H
	Bianco	Silver	Nero opaco
<b>R90AGEPTPS-</b>			



X 90 cm  
Y 4,5 cm  
Z 10 cm

## PORTA-SALVIETTA CON MENSOLA LUMINOSA

da abbinare a vasca Divina, Calos 2.0, Stile, Sense 3-4 e Sense 2.0 3-4 con pannello in legno

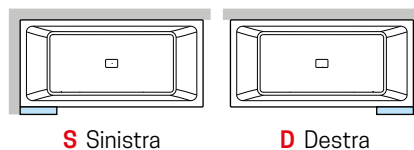

Misure (cm)	Codice	Destra	Sinistra	Scelta finitura / prezzo		
		D-	S-	A	B	H
				Bianco	Silver	Nero opaco
90	<b>R90AGEBPSML</b>	D-	S-			



X 146/166/176 cm  
Y 4,5 cm  
Z 9 cm

## MENSOLA LUMINOSA CON PORTA OGGETTI

da abbinare a vasca Divina, Calos 2.0, Stile, Sense 3-4 e Sense 2.0 3-4 con pannello in legno

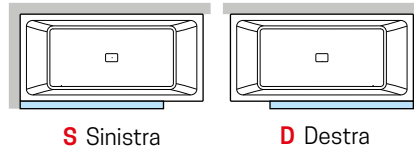
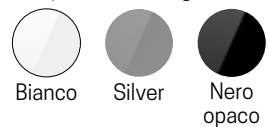

Misura vasca (cm)	Codice	Destra	Sinistra	Scelta finitura / prezzo		
		D-	S-	A	B	H
				Bianco	Silver	Nero opaco
150-160	<b>R90AGEBPSM150</b>	D-	S-			
170	<b>R90AGEBPSM170</b>	D-	S-			
180-190	<b>R90AGEBPSM180</b>	D-	S-			





X 30/45/65 cm  
Y 4,5 cm  
Z 10 cm

## PORTA-SALVIETTA

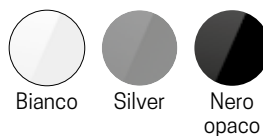

Misure (cm)	Codice	Scelta finitura / prezzo		
		A	B	H
30	<b>R90AGEBPS30-</b>	Bianco	Silver	Nero opaco
45	<b>R90AGEBPS45-</b>			
65	<b>R90AGEBPS65-</b>			



## TERGIVETRO

Tergivetro in metallo cromato e gomma (appendino escluso)

Codice	Prezzo
<b>R90RACLA0B</b>	

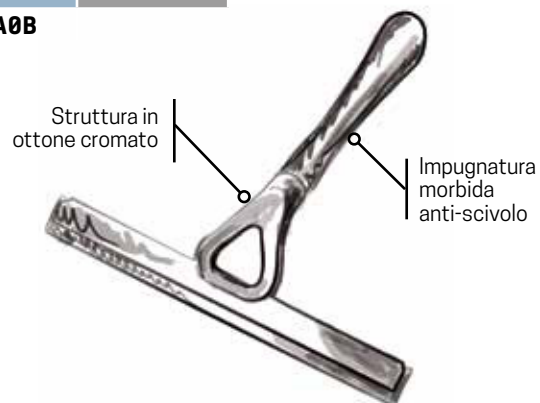

## TERGIVETRO

Tergivetro in metallo cromato e gomma (appendino escluso)

Codice	Prezzo
<b>R90RACLA0A</b>	

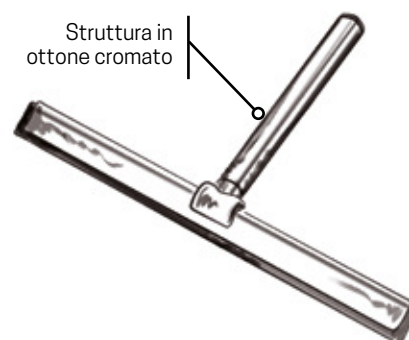



# QUALITÀ E SICUREZZA

## IL NOSTRO IMPEGNO PER LA VOSTRA SICUREZZA

Ogni nostro prodotto è progettato e realizzato per soddisfare le più recenti normative europee in materia di qualità e sicurezza.

Dalle materie prime utilizzate ai semilavorati, all'assemblaggio dei diversi componenti, ogni fase è attentamente pianificata, monitorata e testata per garantire risultati sempre ai massimi livelli degli standard richiesti dal mercato internazionale. I materiali utilizzati per l'imballaggio sono completamente riciclabili e conformi alla direttiva 94/62/CE.

Un impegno quotidiano che intende ripagare la fiducia dei nostri affezionati clienti.

## SAUNA DI VAPORE UMIDO

Le saune di vapore umido Novellini sono conformi alle seguenti direttive europee: **UE 305/2011, 2014/35/UE, 2014/30/UE, 2014/53/UE.**

Con riferimento alle norme armonizzate:

- EN 15200
- EN 60335-1
- EN 60335-2-105
- EN 62233
- EN 60479
- EN 55014-1
- EN 55014-2
- EN 61000-3-2
- EN 61000-3-3
- EN 301 489-17 V3.2.0
- EN 301 489-1 V2.2.0
- EN 300 328 V2.1.1



## VASCHE IDROMASSAGGIO

Le vasche idromassaggio Novellini sono conformi alle seguenti direttive Europee: Regolamento **UE 305/2011, 2014/35/UE, 2014/30/UE, 2014/53/UE.** Con riferimento alle norme armonizzate:

- EN12764:2018
- EN 60335-1
- EN 60335-2-60
- EN 62233
- EN 60479
- EN 55014-1
- EN 55014-2
- EN 61000-3-2
- EN 61000-3-3
- EN 301 489-17 V3.2.0
- EN 301 489-1 V2.2.0
- EN 300 328 V2.1.1



<b>CE</b>	
Novellini Spa - Via Mantova, 1023 46034 Romanore di Borgo Virgilio - Mantova - Italy	
07	
EN 12764:2018	
Bagno idromassaggio, destinato ad essere utilizzato per l'igiene personale	
Resistenza all'intrappolamento dei capelli:	Passa
Pulibilità:	Passa
Durabilità della pulibilità:	Passa

## MATERIALI PLASTICI

Tutti i materiali plastici utilizzati per la produzione di prodotti Novellini (Acrilico, Metacrilato, ABS, etc.) sono sottoposti a scrupolosi controlli per verificarne la compattezza, lo spessore e l'omogeneità.

## TERMOARREDI SOLE

I termoarredi Sole sono conformi alle seguenti direttive europee: **UE 305/2011, 2014/35/UE, 2014/30/UE, 2014/53/UE, 2009/125/CE** (regolamento **UE 2015/1188**) con riferimento alle norme armonizzate:

- EN 60335-1
- EN 60335-2-30
- EN 62233
- EN 60479
- EN 55014-1
- EN 55014-2
- EN 61000-3-2
- EN 61000-3-3
- EN 301 489-17 V3.2.0
- EN 301 489-1 V2.2.0
- EN 300 328 V2.1.1

## PARETI DOCCIA

Le pareti doccia Novellini per impieghi domestici di propria fabbricazione sono conformi alla **EN 14428** (Pareti Doccia- Requisiti funzionali e metodi di prova). Questa dichiarazione è basata sulla conformità dei prodotti alla norma seguente: **EN 14428:2018**, con riferimento alle norme armonizzate:

- EN 12150-1:2019
- ISO 7599
- EN ISO 2409
- ISO7892

<b>CE</b>	
Novellini Spa - Via Mantova, 1023 46034 Romanore di Borgo Virgilio - Mantova - Italy	
<b>EN 14428 :2018</b>	

## PIATTI DOCCIA

I Piatti doccia doccia Novellini per impieghi domestici di propria fabbricazione sono conformi alla **EN 14527 :2019**

**ANNEX B:** Quando bagnata, la superficie della maggioranza dei piatti doccia da un aumento nel potenziale scivolamento. Ciò è in particolare vero quando si utilizzano sapone, shampoo, olio da bagno, ecc. è importante che i progettisti, gli installatori e gli utilizzatori ne siano consapevoli.

<b>CE</b>	
Novellini Spa - Via Mantova, 1023 46034 Romanore di Borgo Virgilio - Mantova - Italy	
<b>12</b>	
<b>EN 14527-CL 1</b>	



È VIETATO METTERE SILICONE ALL'INTERNO DELLE PARETI DOCCIA

**Le pareti doccia e i piatti doccia di propria fabbricazione sono conformi al nuovo Regolamento UE 305/2011**

# DIRETTIVA REACH

## **Applicazione del Regolamento n° 1907/2006 (Direttiva REACH)**

Il 1° giugno 2007 è entrato in vigore in tutta l'Unione Europea il nuovo sistema di regolarizzazione (REACH - REGOLAMENTO (CE) N. 1907/2006) per la valutazione, la registrazione ed il controllo dell'immissione di sostanze e preparati chimici sul mercato europeo. Questo prevede che tutte le sostanze chimiche prodotte o importate nell'Unione Europea in quantità superiore ad 1 tonnellata/anno debbano essere registrate presso l'Agenzia Europea della Chimica (ECHA). Al fine di usufruire di un periodo transitorio durante il quale sarà possibile preparare il dossier di registrazione, è necessario effettuare una registrazione preliminare entro il 01/12/08. Si ricorda che, se entro tale data non è stata effettuata la pre-registrazione, la sostanza in oggetto non potrà essere immessa sul mercato finché non sarà stata effettuata la registrazione.

A tal proposito si comunica che la Novellini S.p.A. riveste solamente il ruolo di utilizzatore a valle non producendo o importando sostanze all'interno dell' UE, quindi non deve assolvere gli obblighi relativi alla registrazione di tali sostanze.

Al fine di garantirVi l'abituale continuità nella fornitura dei nostri

prodotti con la presente siamo a comunicarVi che ci stiamo assicurando che i nostri fornitori, qualora ricorra il caso, effettuino la pre-registrazione. Nel caso ciò non avvenisse sostituiremo le sostanze in uso con altre che rispondano ai requisiti delle norme cogenti. Comunque la nostra fornitura non subirà alcuna modifica a valle degli obblighi REACH.

Per quanto riguarda i nostri prodotti si evidenzia che si inseriscono tutti nella definizione di articolo presente nel Regolamento (CE) N. 1907/2006 del Parlamento Europeo e del Consiglio del 18 dicembre 2006. In particolare ai sensi dell'art. 7 "Registrazione e notifica delle sostanze contenute in articoli", comma 1 lettera b), tali articoli non risultano soggetti a registrazione in quanto eventuali sostanze in essi contenute non sono destinate a essere rilasciate in condizioni d'uso normali o ragionevolmente prevedibili. Si specifica inoltre che, sempre ai sensi del Regolamento (CE) N. 1907/2006, i suddetti articoli, in base alle loro caratteristiche, non rientrano negli obblighi previsti dall'art. 33 "Obbligo di comunicare informazioni sulle sostanze presenti negli articoli" in quanto la percentuale in peso delle sostanze ritenute pericolose, ai sensi della presente normativa, è inferiore allo 0,1% del peso totale dell'articolo.

## CONDIZIONI GENERALI DI VENDITA

### **ORDINI**

Gli ordini sono impegnativi per il Committente, mentre avranno valore di semplice proposta per la Novellini. Gli ordini divengono definitivi solo dopo esplicita accettazione oppure, nel caso di assenza di accettazione esplicita, dopo un periodo di 15 giorni dal ricevimento in sede dell'ordine medesimo. Gli ordini possono essere evasi anche parzialmente ed in più riprese.

### **ANNULLAMENTO ORDINI**

Nessun annullamento di ordini verrà accettato senza la preventiva ed esplicita autorizzazione della Novellini, che si riserva comunque la facoltà di addebitare eventuali spese ed oneri conseguenti.

### **ORDINI SPECIALI**

L'ordine di prodotti speciali deve sempre pervenire in forma scritta e deve essere accompagnato da un anticipo pari al 25% almeno dell'intero importo. Su tali ordini non si accetteranno resi o annullamenti di nessun tipo.

### **TEMPI DI CONSEGNA**

I tempi di consegna sono puramente indicativi e non costituiranno in nessun caso motivo di annullamento totale o parziale dell'ordine, né per richiesta di risarcimento ad alcun titolo. Qualora il termine di consegna sia essenziale per l'acquirente, andrà specificatamente segnalato per iscritto al momento del conferimento dell'ordine.

### **PREZZI E PAGAMENTI**

I prezzi di vendita corrispondono a quelli riportati sul listino ufficiale alla data della stipulazione dell'ordine. La Novellini si riserva la facoltà di effettuare variazioni di tali prezzi anche senza preavviso. Gli ordini già in essere e con una programmazione di consegna oltre i 60 giorni dalla data di entrata in vigore dei nuovi listini, verranno assoggettati al nuovo regime di prezzi.

Le condizioni di pagamento sono quelle pattuite specificatamente per ogni cliente. In caso di clienti nuovi, o di variazioni delle condizioni stesse, tali condizioni andranno espressamente dichiarate al momento dell'ordine e successivamente approvate dalla Novellini.

In caso di ritardato pagamento, verranno addebitati gli interessi di legge. Tutte le vendite effettuate avverranno in regime di riserva di proprietà, rimanendo di proprietà esclusiva della Novellini fino al completo pagamento delle stesse.

### **IMBALLO**

Il prezzo pattuito per i prodotti Novellini si intende comprensivo di normale imballo. Nel caso di particolari esigenze di trasporto e di conseguente imballo, verrà pattuito un prezzo speciale in funzione del costo aggiuntivo sopportato. I pallets in ferro utilizzati per il trasporto dei prodotti Novellini,

si considerano "a rendere" in quanto di proprietà del venditore. In caso di mancato restituzione, l'azienda si riserva la facoltà di riaddebitarne il valore. Tali pallets in ferro sono stati progettati ad esclusivo uso prodotti del venditore. Il venditore si solleva da ogni responsabilità per un uso improprio di questo bene.

### **TRASPORTO**

Si rinvia all'art. 1510 del Codice Civile.

### **GARANZIA**

La merce si intende coperta da garanzia secondo quanto previsto dal Codice Civile Italiano, dalle leggi speciali e dalla normativa europea in materia. Tale garanzia è estesa a 2 anni dalla data di consegna del prodotto e verrà presa in considerazione solo dietro reclamo scritto. Non verrà riconosciuta alcuna garanzia qualora, in caso di vizio di conformità riconoscibile risultante all'apertura dell'imballo, il prodotto venga comunque installato e ne sia fatta denuncia solo successivamente.

### **RESI DI MERCE**

L'eventuale reso di prodotti Novellini dovrà essere sempre effettuato dopo specifica autorizzazione, da richiedere caso per caso.

In caso di reso per errore cliente rimarranno comunque a carico del committente, per spese generali di ripristino e immagazzinaggio, purchè il prodotto sia integro; nel caso in cui il prodotto risulti danneggiato o non integro, l'azienda si riserva di valutare di volta in volta il valore da accreditare.

### **CONTROVERSIE LEGALI**

Le condizioni suddette vengono integralmente accettate dal committente al momento del conferimento dell'ordine alla Novellini. Per ogni controversia in merito, l'unico Foro competente è quello di Mantova.

Tutti i prodotti sono assicurati per i danni cagionati al consumatore conformemente alla direttiva comunitaria CEE 85/374 del 1985, e s.m.i, con XL Group - Insurance Company PLC.

In caso di fuori squadra dei muri o del piatto, ondulazioni degli stessi, la Novellini S.P.A. declina ogni responsabilità per eventuali difficoltà o impossibilità di installazione del prodotto, così come non risponderà per eventuali perdite di acqua o malfunzionamenti vari.

La Novellini si riserva di apportare modifiche parziali o radicali ai prodotti, nonché di deciderne l'eliminazione dal catalogo anche senza preavviso. Gli allestimenti e le tonalità di colori delle fotografie sono puramente indicativi.

Il presente listino annulla e sostituisce i precedenti. Le immagini e i dati contenuti nel presente catalogo sono da ritenersi indicativi e possono subire variazioni anche senza alcun preavviso.

NOVITÀ



 **NOVELLINI**  
STORE**PRO**

## TUTTO IL MONDO NOVELLINI A PORTATA DI APP

**LA NUOVA APP PER IL TUO SMARTPHONE DEDICATA  
AGLI IDRAULICI E A TUTTI I PROFESSIONISTI  
DEL SETTORE SCARICABILE GRATUITAMENTE  
PER IOS E ANDROID**

[StorePro.novellini.com](http://StorePro.novellini.com)

Permette la ricerca dei prodotti e la creazione dei preventivi. Aperta a idraulici, architetti e altri professionisti del settore.

Disponibile sia come portale Web che come App per smartphone Android e iPhone.

Utilizzabile dovunque con la stessa semplicità di Novellini Store per trovare il prodotto più adatto, conoscerne disponibilità e prezzo, e scaricare i documenti e i disegni tecnici.

IOS



ANDROID





# **IN STOCK**



PRODOTTI SEMPRE  
DISPONIBILI  
IN GRANDE QUANTITÀ

[store.novellini.com](http://store.novellini.com)

Visita di frequente lo STORE NOVELLINI per essere sempre aggiornato e rispondere al meglio alle richieste dei tuoi clienti.

Impara a riconoscere questo simbolo lo trovi nello STORE NOVELLINI e su ogni prodotto **IN STOCK** 

**RICHIEDI IL TUO ACCOUNT  
ED APPROFITTA  
DEGLI INCREDIBILI VANTAGGI!!!**

Gli **IN STOCK** Novellini sono una selezione di prodotti **SEMPRE** disponibili a magazzino in **GRANDE QUANTITÀ**. Includono box doccia, vasche, piatti e colonne in diversi modelli, misure e finiture.

L'elenco completo degli articoli **IN STOCK** lo trovi nel nuovo listino **IN STOCK** Novellini (richiedilo al tuo agente di zona) o sullo Store Novellini nella sezione dedicata agli **IN STOCK**.

Nel presente listino i codici degli **IN STOCK** Novellini li identifichi grazie ai BOLLINI BLU ●.



---

## IL SERVIZIO CLIENTI NOVELLINI

---



### **CUSTOMER CARE**

OFFERTE COMMERCIALI  
CONSULENZE COMMERCIALI  
TEMPI E STATO CONSEGNE  
ANOMALIE CONSEGNE  
RICHIESTE DI RESO  
CONSULENZE PRE E POST  
INSTALLAZIONE PRODOTTI  
CONSULENZE E PREVENTIVI  
SOLUZIONI SPECIALI  
RICHIESTE SOPRALLUOGHI  
ED INTERVENTI TECNICI  
RICHIESTE RICAMBISTICA  
RICHIESTE INTERVENTI  
CENTRI ASSISTENZA

---

 **0376 6421**



### **GESTIONE ORDINI**

---

 **ordini@novellini.it**  
 **0376 641679**













### **CONTABILITÀ CLIENTI**

---

 **contabilitaclienti@novellini.it**  
 **0376 642450**

## LEGENDA SIMBOLI BOX DOCCIA

 Altezza box	 Non reversibile	 Impermeabilità soddisfacente
 Spessore vetro	 Sollevamento anta in apertura / chiusura	 Impermeabilità non garantita al 100%
 Estensibilità	 Soft opening-closing	
 Reversibile	 Impermeabilità ottima	

## LEGENDA SIMBOLI CABINE DOCCIA E COLONNE MULTIFUNZIONE

 Altezza cabina	 Doccia a cascata	 Ripiano portaoggetti
 Altezza utile interna	 Sauna di vapore + erogatore con dispenser di aromi	 Poggiapiedi
 Spessore vetro	 Chromolight	 Bluetooth
 Idromassaggio verticale e dorsale	 Illuminazione LED interna	 Radio RDS stereo con diffusori acustici
 Idromassaggio cervicale	 Telecomando Touch Screen	 Specchio
 Idromassaggio plantare	 Pannello elettronico	 Tettuccio
 Rotopoggia	 Doccetta a mano con flessibile	 Pedana
 Soffione pioggia	 Sedile	 Disegni tecnici

## LEGENDA SIMBOLI VASCHE

 Idromassaggio Airpool	 Pannello accensione soft-touch	 Colonna di scarico (tranne vasche ad incasso)
 Idromassaggio Airpool dorsale	 Disinfezione	 Colonna di scarico con piletta click-clack
 Idromassaggio Whirlpool laterale	 Rubinetteria bordo vasca	 Bluetooth
 Idromassaggio Whirlpool dorsale	 Telecomando Touch Screen	 Radio RDS stereo
 Idromassaggio Whirlpool plantare	 Pannello elettronico con funzioni Hydro Sequence	 Presa AUX per MP3
 Natural Air	 Telecomando ON/OFF	 Tubo di scarico salvagoccia
 Chromolight	 Poggiatesta impermeabile, antibatterico e atossico	 Disegni tecnici
 Riscaldatore	 Sedile	



**NOVELLINI spa**

Via Mantova, 1023 - 46034 Borgo Virgilio - Loc. Romanore - Mantova - Italy  
Tel. +39 0376 64 21 | Fax +39 0376 64 22 50 | [info@novellini.com](mailto:info@novellini.com)

  
Designed and  
manufactured  
in **ITALY**



[www.novellini.com](http://www.novellini.com)



[www.novellini.com/facebook](http://www.novellini.com/facebook)



[www.novellini.com/instagram](http://www.novellini.com/instagram)



[www.novellini.com/YouTube](http://www.novellini.com/YouTube)



[www.novellini.com/Linkedin](http://www.novellini.com/Linkedin)



[www.novellini.com/Pinterest](http://www.novellini.com/Pinterest)